



DENHART
INDUSTRY

SURGICAL INSTRUMENTS CATALOGUE



Bheri Post Office Marakiwal
Sialkot, 51310 Pakistan



Tel: +971 56 608 5905
Tel: +92 307-6246984



info@denhartinds.com
mianaqib923@gmail.com



01-101
TROEMNER
Size: 245 mm



01-102
DEJERINE
Size: 200 mm



01-103
DEJERINE
With Needle
Size: 210 mm



01-104
TAYLOR
Size: 195 mm

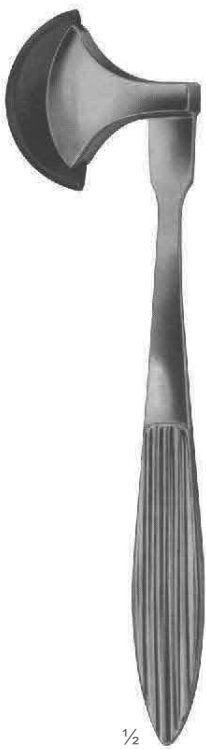

01-105
BERLINER
Size: 200 mm

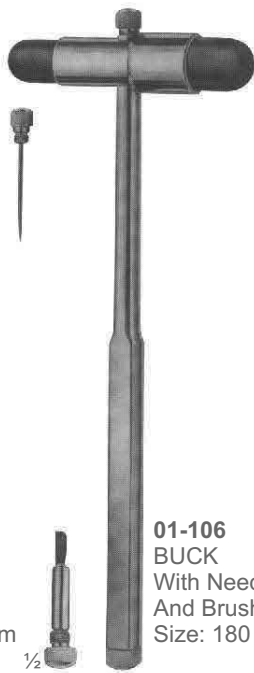

01-106
BUCK
With Needle
And Brush
Size: 180 mm

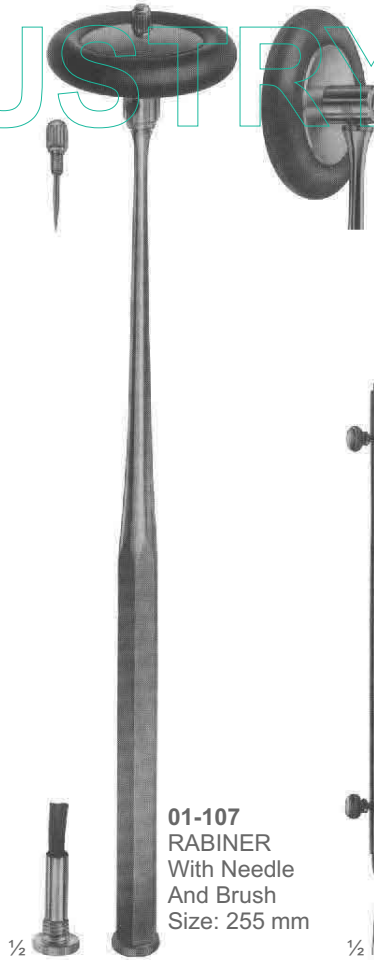

01-107
RABINER
With Needle
And Brush
Size: 255 mm



01-108
ALY
Size: 190 mm



01-109
WARTENBERG
Pinwheel For
Neurological
Examination
Size: 185 mm

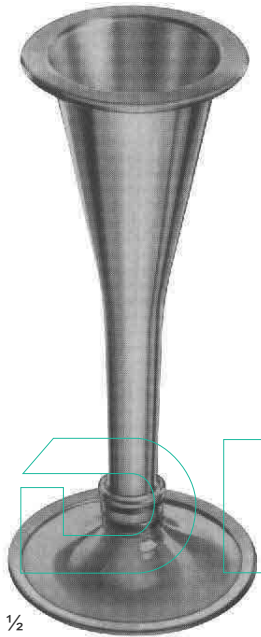

01-110
PINARD (Aluminum)
Size: 155 mm

1/2

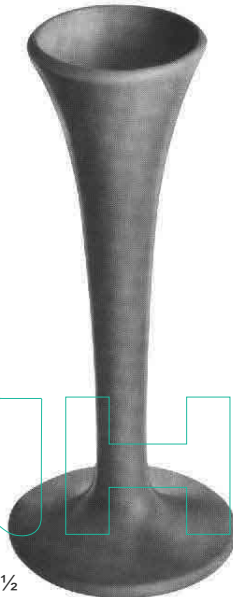

01-111
aus Holz (Wooden)
Size: 145 mm

1/2



01-112
BOWLES
Stethoscope
With Diaphragm

1/4

INDUSTRY

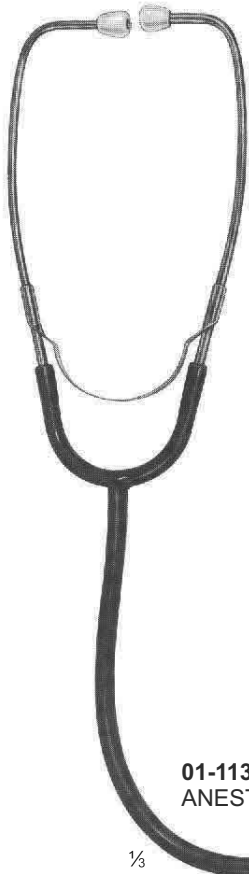

01-113
ANESTOPHON

1/3



01-114
FORD-BOWLES
Duel Chest Piece
With Two Outlets

1/4



01-115
BOWLES

1/4

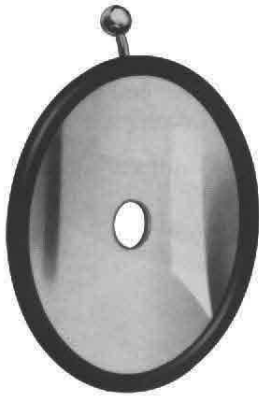

01-116
ZIEGLER Ø mm
Head mirror only
with rubber coating

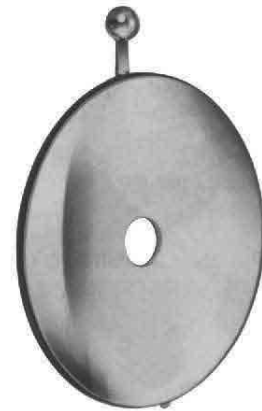

01-117
ZIEGLER Ø mm
Head mirror only
with metal coating



01-118
ZIEGLER
Head band of plastic black

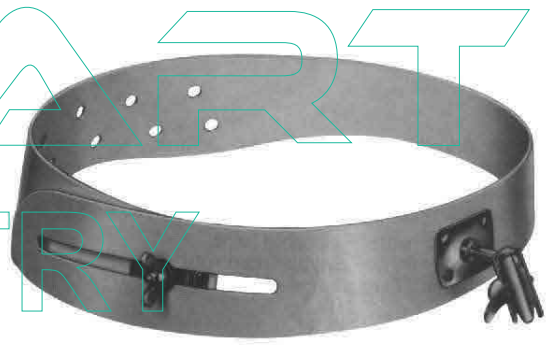

01-120
MURPHY
Head band of celluloid, white

01-119
ZIEGLER
Head band of plastic white

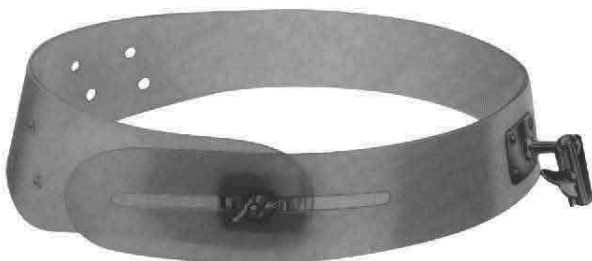

01-121
Head band of plastic,
white, soft pattern



01-122
Head mirror with black
plastic head band.

01-123
CLAR
Head light, 6 volt, with adjustable joint,
white celluloid head band,
cord with plugs for transformer

01-124
White celluloid head band, only, for

01-125
Spare mirror only, for



01-126
spare bulb

DENHART
INDUSTRY

01-127
CLAR
Head light, 6 volt, with adjustable joint,
white celluloid head band, with foam rubber pad
and cord with plugs for transformer

01-128
White celluloid head band, only, for head light

01-129
mirror only, for head light

spare foam rubber pad, for head band

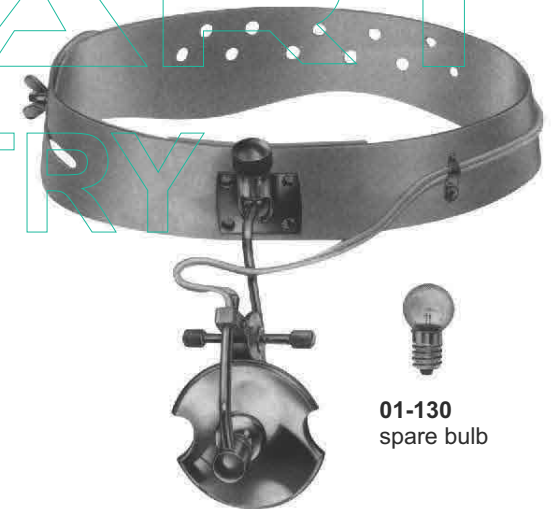

01-130
spare bulb

01-131
CLAR
Head light, 6 volt, with adjustable joint,
white plastic head band,
cord with plugs for transformer



01-132
spare bulb

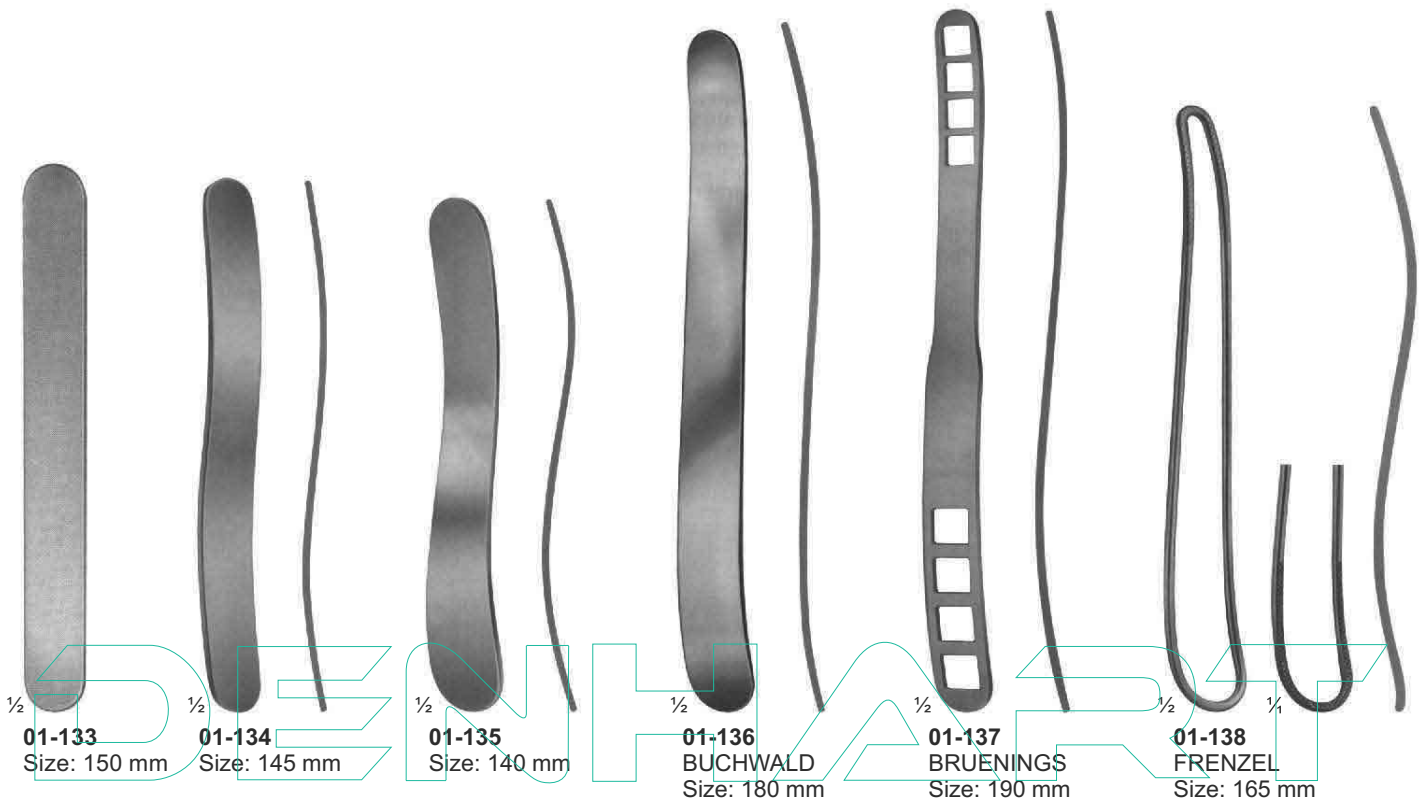

INDUSTRY

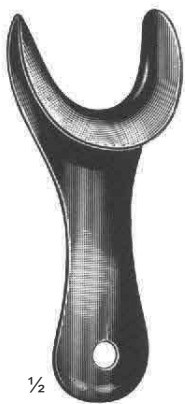
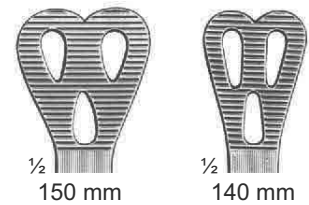

01-139
 SIMPLEX
 Size: 110 mm



01-140
 STEMBERG
 Size: 120 mm, 140 mm, 160 mm

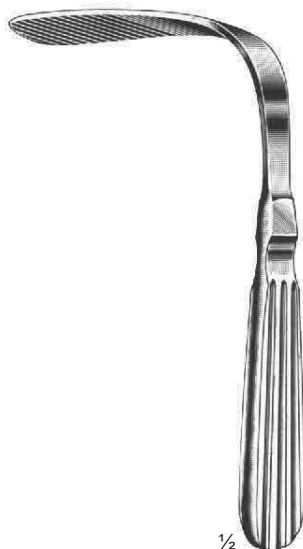

01-141
 TOBOLD
 Size: 145 mm



01-142
 ANDREW
 Size: 110 mm



01-143
 WIEDER



1/2

01-144
SCHIMMELBUSCH
Ether Mask



1/2

01-145
HEISTER
Mouth Gag
Size: 130 mm



1/2

01-146
FERGUSON-ACKLAND
Mouth Gag
Size: 145 mm



1/2

01-147
DENHART
Mouth Gag With Silicon
Inserts, Interchangeable
Size: 125 mm



1/2

01-148
ROSER KONIG
Mouth Gag
Size: 160 mm, 185 mm

INDUSTRY



1/2

01-149
YOUNG
Size: 165 mm



1/4
1 Pair Of
Rubber Pads

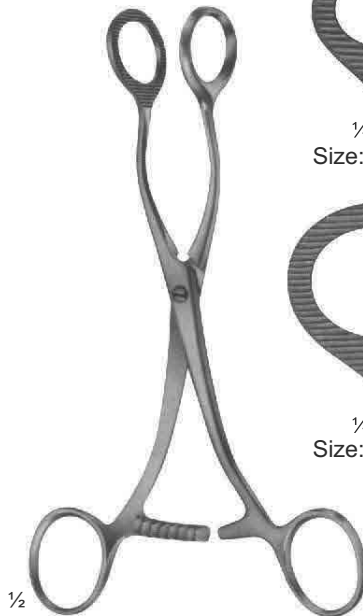

1/2

01-150
COLLIN
Size: 160 mm, 170 mm



1/4
Size: 160 mm



1/4
Size: 170 mm

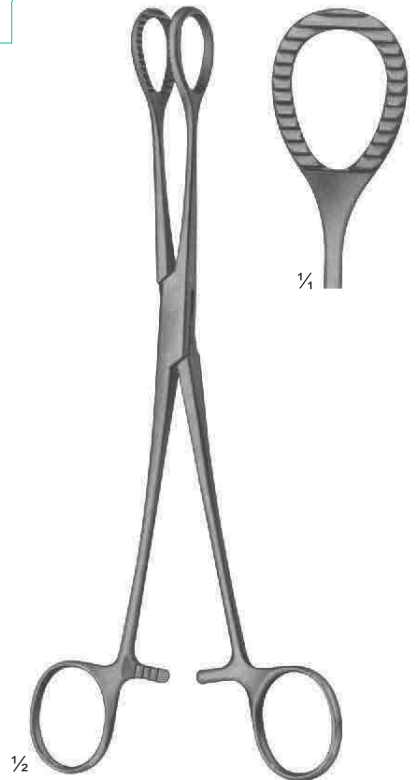

1/2

01-151
HEYWOOD-SMITH modif.
Size: 215 mm



Fig. 000



Fig. 00



Fig. 0



Fig. 1

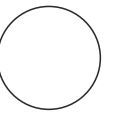

Fig. 2

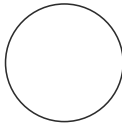

Fig. 3

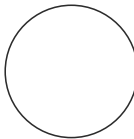

Fig. 4

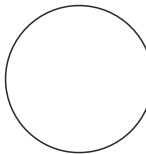

Fig. 5

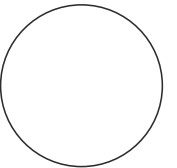

Fig. 6

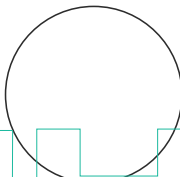

Fig. 7

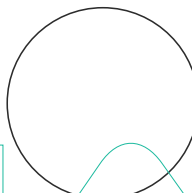

Fig. 8

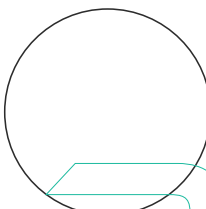

Fig. 9

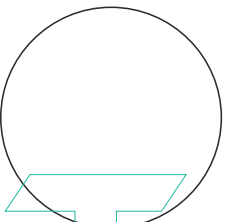

Fig. 10



01-152
FRANCKE
Automatic Blood Lancet



01-153
KOLLE
Microscopic Needle Holder
With Plastic Handle
Size: 240 mm



01-158
Spare Mirrors Only
Size: 12 mm



01-159
Spare Mirrors Only
Size: 14 mm



01-154
Laryngeal Mirrors With
Hexagonal Handle
Size: 180 mm



01-155
Mirror Handle
Size: 110 mm



01-156
Mirror Handle
Size: 105 mm



01-157
MICHEL
Rhinoscopic Mirrors With
Interchangeable Mirror Inserts
Size: 250 mm



1/2

01-160 - 162
MAGILL



01-160
Infants
Size: 150 mm



01-161
Children
Size: 200 mm



01-162
Adults
Size: 250 mm

DENHART
INDUSTRY



1/2

01-163
Medium battery handle
only, 25 mm diam.



01-163-A
Spare bulb
2.7 volt, for
otoscopes



01-163-B
Spare bulb
2.6 volt, for
ophthalmoscopes



01-164
Otoscope Set, Consists Of
Battery Handle Without Batteries,
3 Ear Specula, 1 Bulb In Velvet Lined Case



01-165
Diagnostic Set, Otoscope With Three Specula,
Nasal Speculam, Lamp Holder, Two Laryngeal
Mirrors, Tongue Blade Holder



01-166
MILLER
Laryngoscope Set, Consists Of Battery Handle (Without Battery)
With Four Miller Laryngoscope Blades

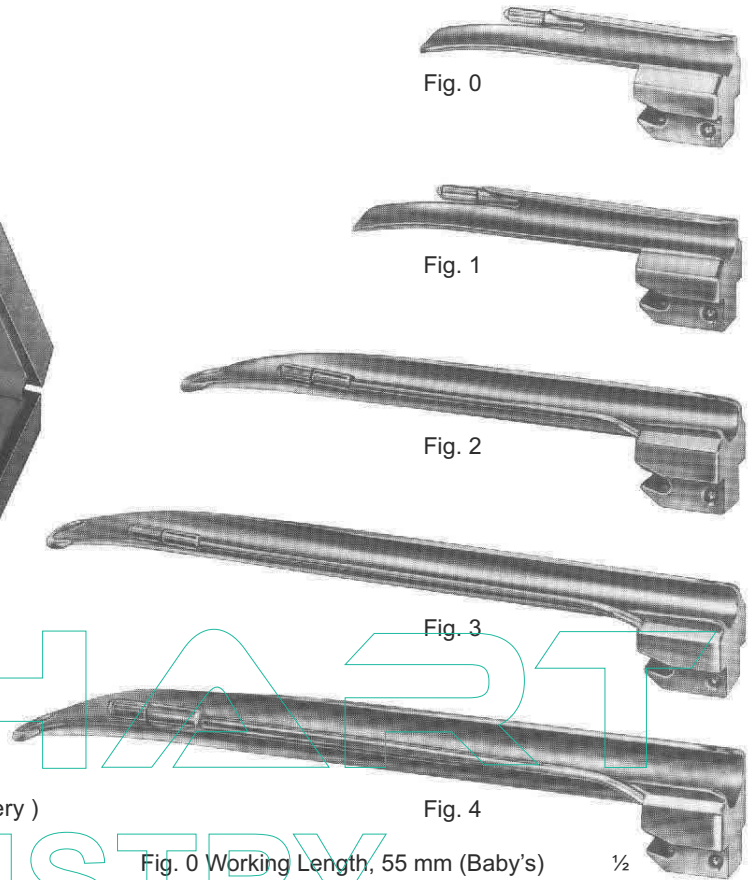

Fig. 0 Working Length, 55 mm (Baby's)
Fig. 1 Working Length, 80 mm (Children's)
Fig. 2 Working Length, 130 mm (Adolescent's)
Fig. 3 Working Length, 170 mm (Women's)
Fig. 4 Working Length, 180 mm (Men's)



01-167
GUEDEL-NEGUS
Laryngoscope Set, Consists Of Battery Handle (Without Battery)
With Four Miller Laryngoscope Blades

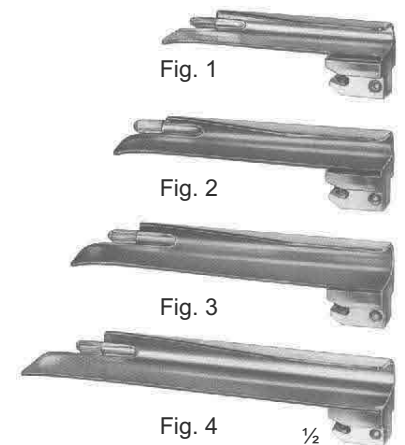

Fig. 1 Working Length, 70 mm (Children's)
Fig. 2 Working Length, 90 mm (Adolescent's)
Fig. 3 Working Length, 110 mm (Women's)
Fig. 4 Working Length, 135 mm (Men's)



1/3

01-168
McIntosh
Laryngoscope Set, Consists Of Battery Handle (Without Battery)
With Three McIntosh Blades, Fig. 1, Fig. 2, Fig. 3

01-169
McIntosh
Laryngoscope Set, Consists Of Battery Handle (Without Battery)
With Five McIntosh Blades, Fig. 1, Fig. 2, Fig. 3, Fig. 4, Fig. 5

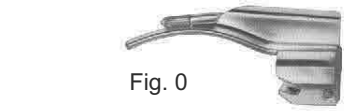

Fig. 0



Fig. 1



Fig. 2



Fig. 3



Fig. 4

1/2

- Fig. 0 Working Length, 55 mm (Baby's)
- Fig. 1 Working Length, 75 mm (Children's)
- Fig. 2 Working Length, 90 mm (Adolescent's)
- Fig. 3 Working Length, 110 mm (Women's)
- Fig. 4 Working Length, 135 mm (Men's)



1/3

01-170
FOREGGER
Laryngoscope Set, Consists Of
Battery Handle (Without Battery)
With Three Foregger Blades,
Fig. 1, Fig. 2, Fig. 3,

01-171
FOREGGER
Laryngoscope Set, Consists Of
Battery Handle (Without Battery)
With Five Foregger Blades,
Fig. 1, Fig. 2, Fig. 3, Fig. 4, Fig. 5



Fig. 1



Fig. 2



Fig. 3

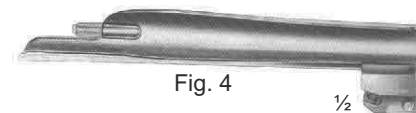

Fig. 4

1/2

- Fig. 1 Working Length, 70 mm (Children's)
- Fig. 2 Working Length, 90 mm (Adolescent's)
- Fig. 3 Working Length, 110 mm (Women's)
- Fig. 4 Working Length, 135 mm (Men's)



1/2

01-172
Fiber Optic
Battery Handle



1/2

01-173
Fiber Optic
Battery Handle



1/4

01-174
Replacement Lamp
(Krypton) 2.5 V



1/4

01-175
Replacement Lamp
(Halogen) 2.5 V

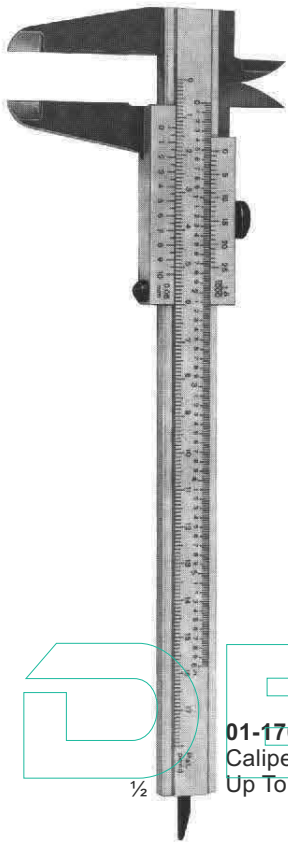

01-176
Caliper Of Aluminum
Up To 180 mm



01-177
VERNIER
Universal Caliper Of Steel
Up To 120 mm

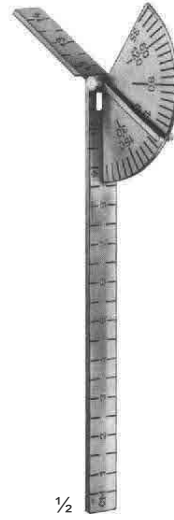

01-178
CAROLL
Size: 140 mm



01-179
TOWNLEY
Size: 100 mm

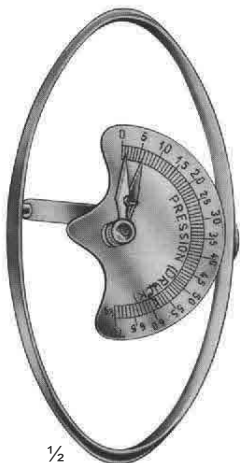

01-180
COLLIN
Druck Pressure 72 kg
Size: 125 mm

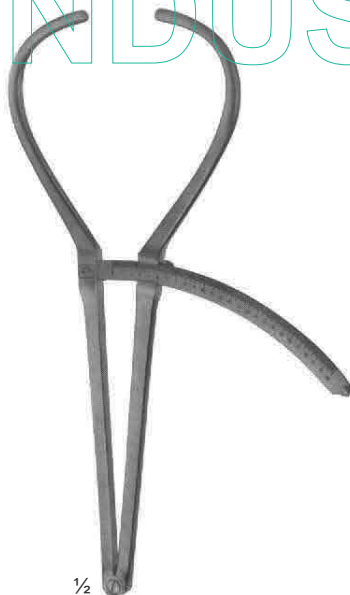

01-181
BERTILLON
Caliper For Measuring The Head
Size: 320 mm



01-182
CASTROVIEJO
Caliper



01-183
MOLTGEN
Goniometer

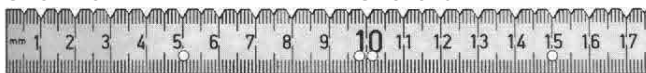

01-185
Size: 150 mm



01-184
Size: 500 mm

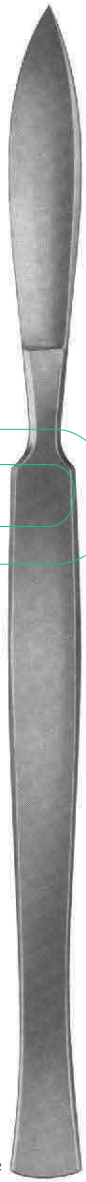

1/2

02-101 - 110
Fig. 1 - 10



1/4

02-101
Fig. 1



02-102
Fig. 2



02-103
Fig. 3



02-104
Fig. 4



02-105
Fig. 5

DENHART
INDUSTRY



1/4

02-106
Fig. 6



02-107
Fig. 7



02-108
Fig. 8



02-109
Fig. 9



02-110
Fig. 10

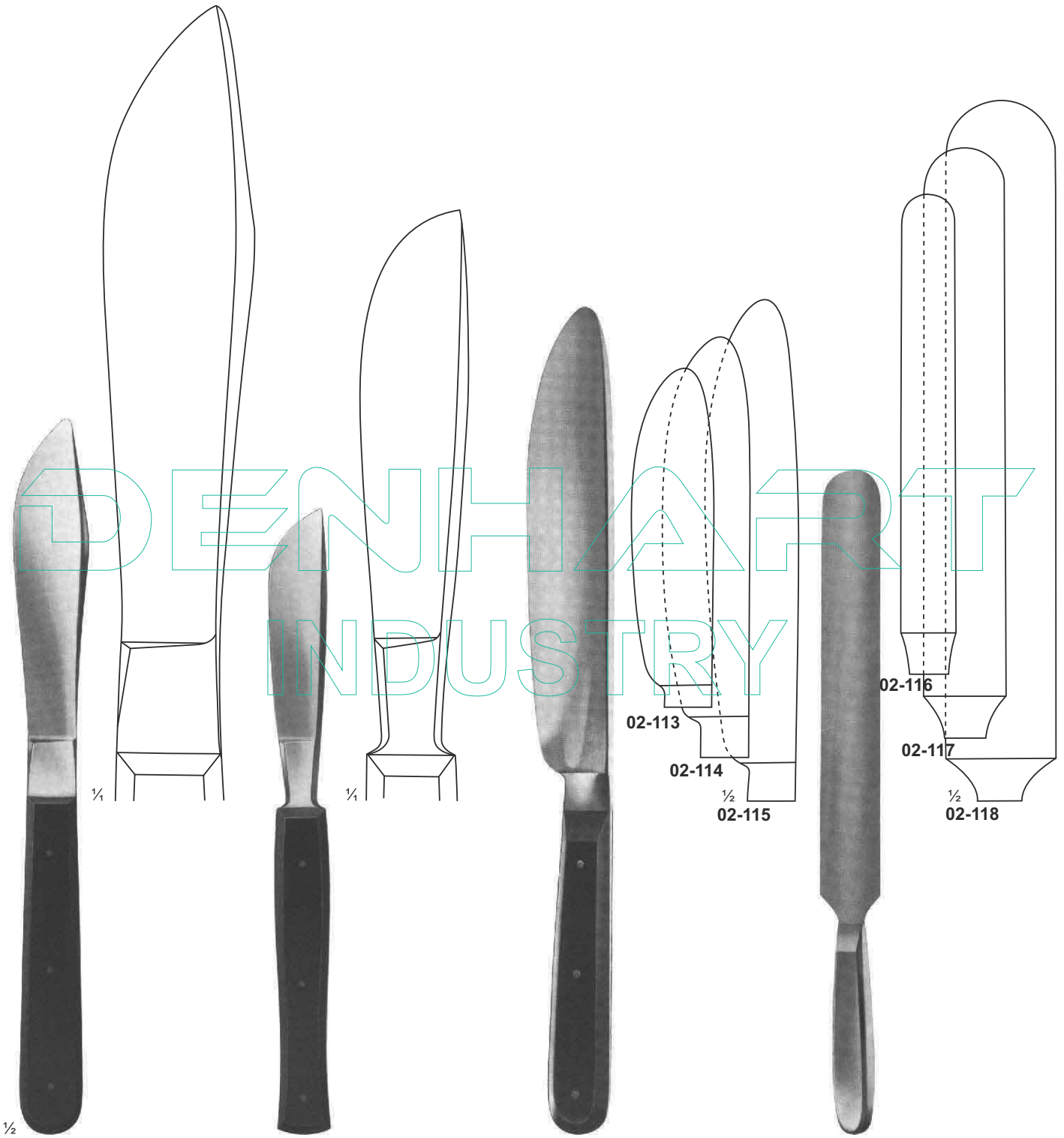

02-111
Size: 255 mm

02-112
VIRCHOW

02-113 - 115
WALB

02-116 - 118
VIRCHOW

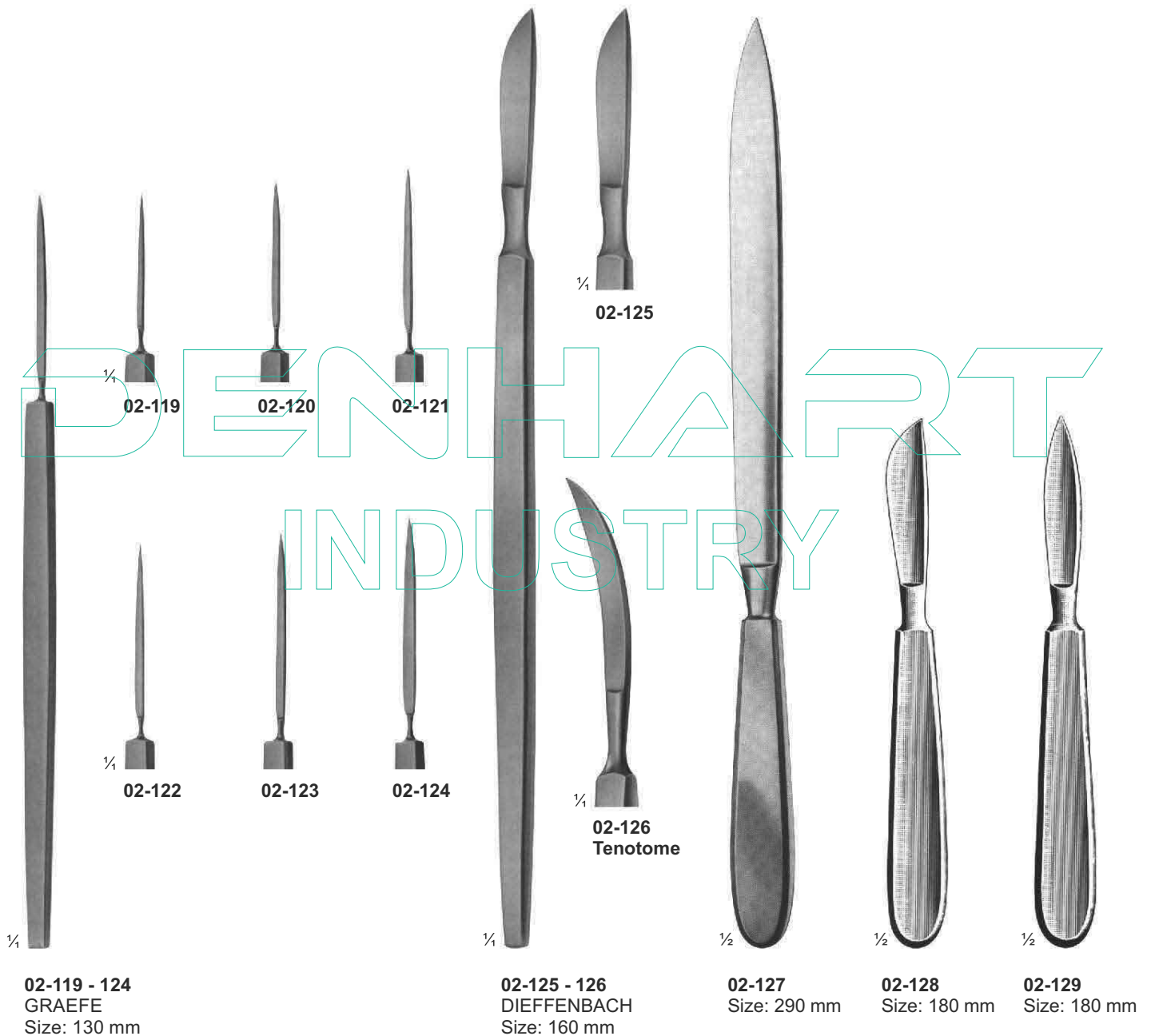



02-130

02-131

02-132

02-133

02-134

02-135

02-136

02-137

02-138

02-139

INDUSTRY

02-130 - 149
Size: 140 mm - 175 mm

02-140

02-141

02-142

02-143

02-144

02-145

02-146

02-147

02-148

02-149
Tenotome



02-150
Size: 130 mm
02-151
Size: 160 mm
02-152
Size: 190 mm
02-153
Size: 200 mm

02-154
CATLIN
Size: 160 mm
Blade Length
Amputating
Knives

02-155
LANGENBECK
Size: 120 mm
Blade Length
Flap Knives

02-156
Size: 110 mm
Blade Length
Interosseous
Knives

02-157
Size: 55 mm
Blade Length
With Raspatory,
Wooden Handle

02-158
Size: 70 mm
Blade Length
Wooden Handle

02-159
Size: 80 mm
Blade Length
Metal Handle

02-160
Size: 195 mm
Blade Length
Metal Handle

Blade Length
Amputating Knives

Cone Knives, Myomatome, Trigeminal & Tonsil Knives



02-161
AYRE
Size: 235 mm
Cone Knife

02-162
Size: 230 mm
Cone Knife

02-163
SEGOND
Size: 270 mm
Myomatome

02-164
OLIVECRONA
Size: 205 mm
Trigeminal
Knife

02-165
Size: 230 mm
Trigeminal
Knife

02-166
FOWLER
Size: 200 mm
Tonsil Knife

02-167
ABRAHAM
Size: 215 mm
Tonsil Knife

02-168
BRUNINGS
Size: 215 mm
Tonsil Knife

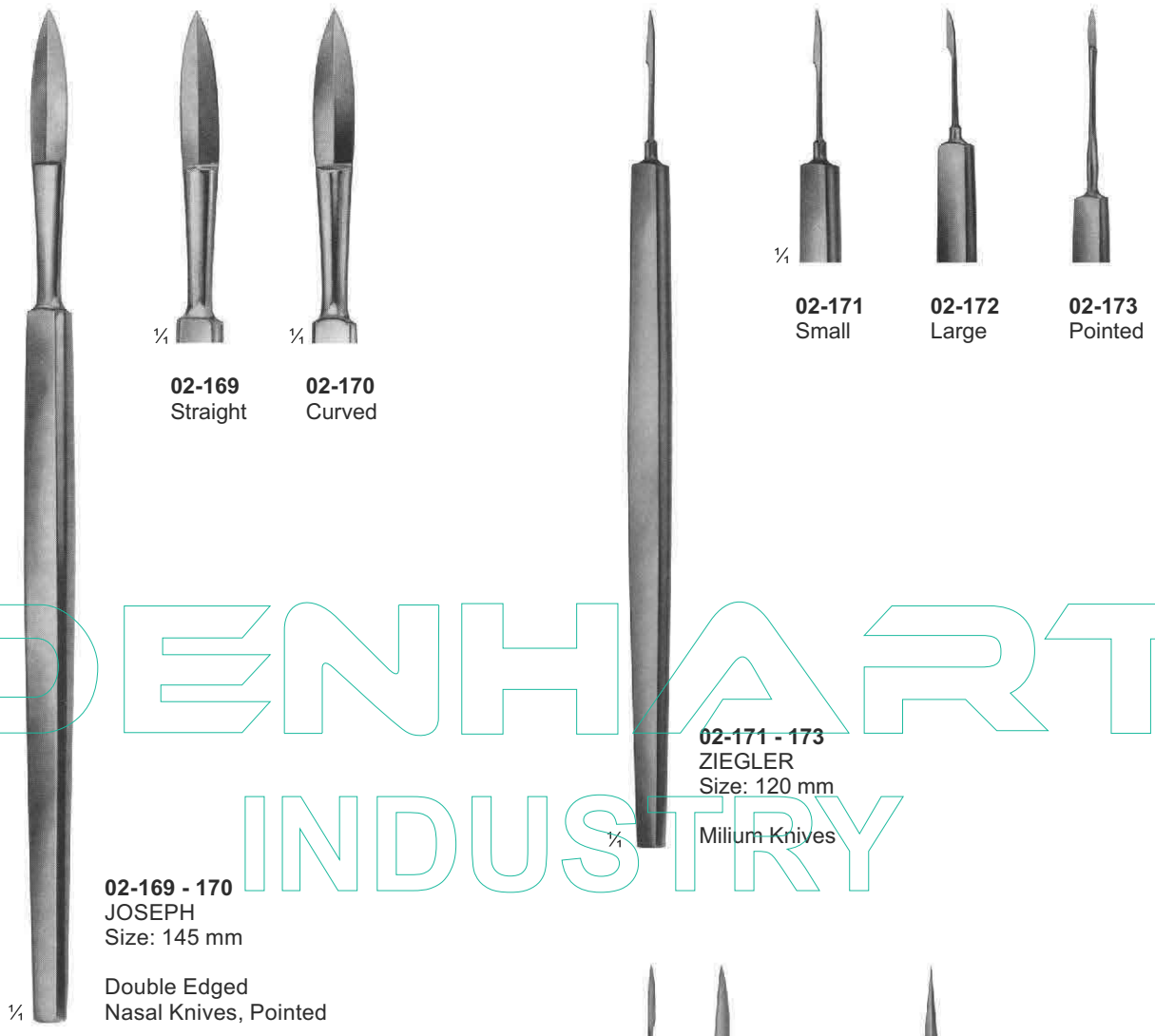

02-169
Straight

02-170
Curved

02-171
Small

02-172
Large

02-173
Pointed

02-171 - 173
ZIEGLER
Size: 120 mm
Milium Knives

02-169 - 170
JOSEPH
Size: 145 mm
Double Edged
Nasal Knives, Pointed

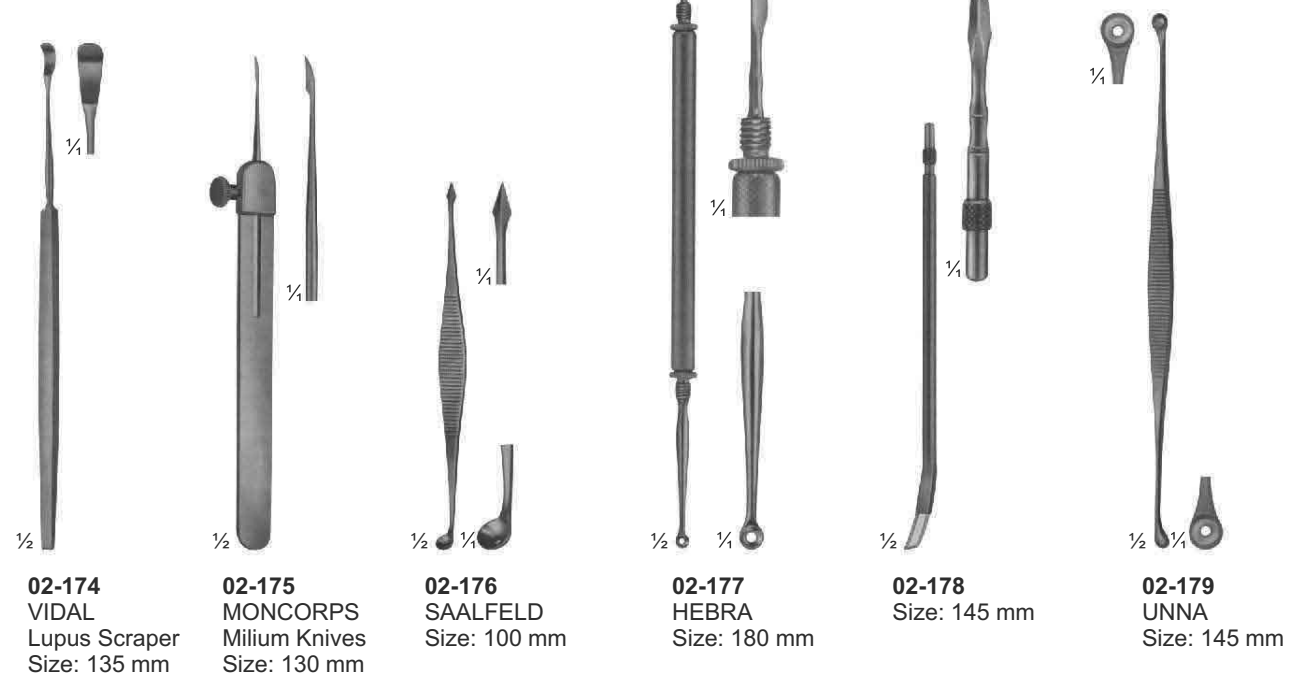

02-174
VIDAL
Lupus Scraper
Size: 135 mm

02-175
MONCORPS
Milium Knives
Size: 130 mm

02-176
SAALFELD
Size: 100 mm

02-177
HEBRA
Size: 180 mm

02-178
Size: 145 mm

02-179
UNNA
Size: 145 mm



02-180
TROUTMAN-CHRIS
Size: 100 mm

02-181
TROUTMAN-CHRIS
Size: 100 mm

02-182
Size: 110 mm

02-183
CASTROVIEJO
Size: 130 mm

02-184
Size: 185 mm



02-185
STANDARD
No. 4
Solid

02-186
Double Handel
No. 4 + No. 3
Solid

02-187
No. 4 L
Straight
Solid

02-188
No. 4 L
Solid Angled

02-189
COLLIN
No. 8
Hollow

02-190
COLLIN
No. 9
Hollow

02-191
Plastic

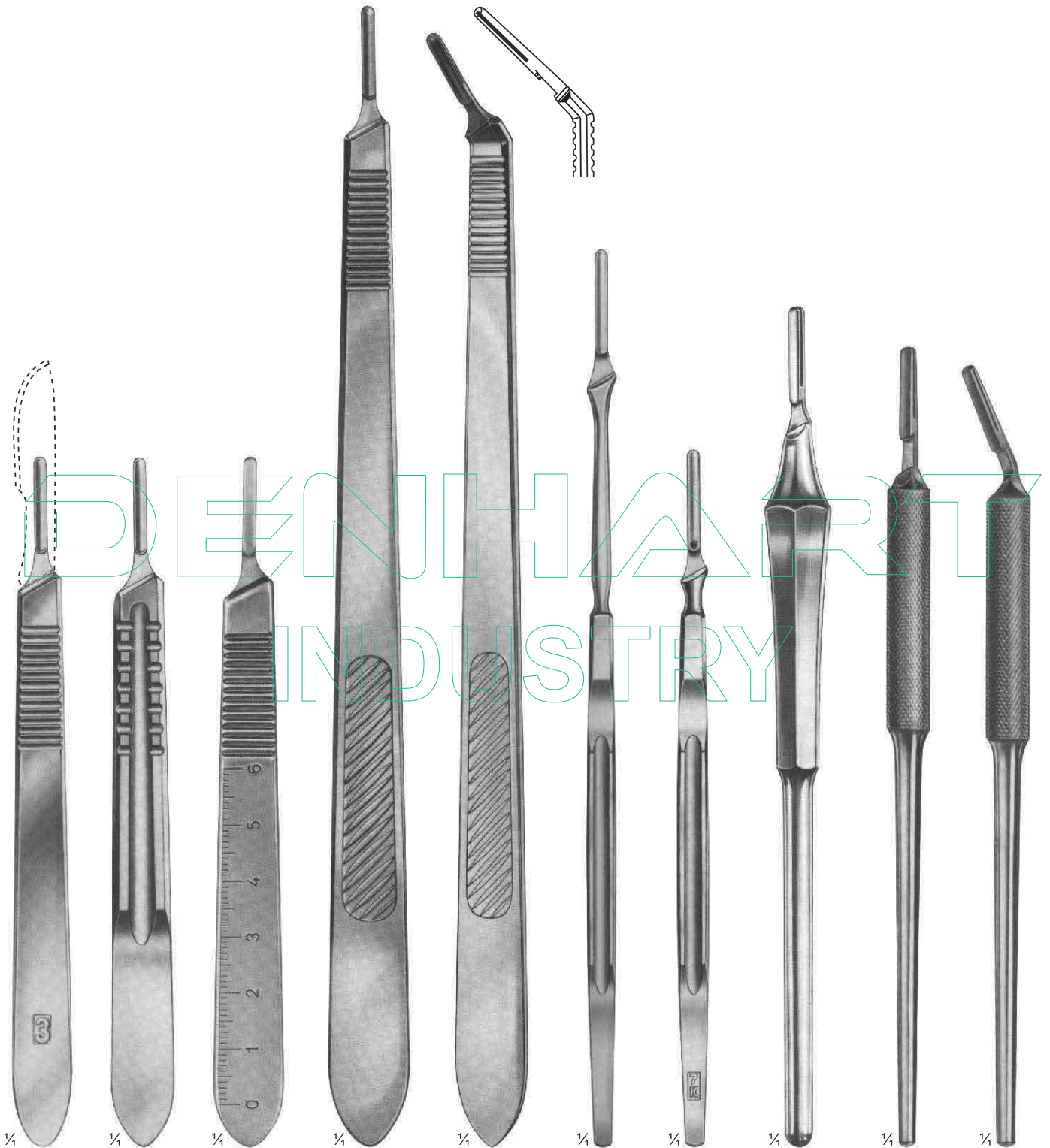

02-192
STANDARD
No. 3
Solid

02-193
No. 3
Solid

02-194
No. 3
Solid

02-195
No. 3 L
Straight
Solid

02-196
No. 3 L
Angled
Solid

02-197
No. 7
Solid

02-198
No. 7 K
Solid

02-199
Hollow-Round

02-200
No. 3
Straight
Solid

02-201
No. 3
Angled
Solid

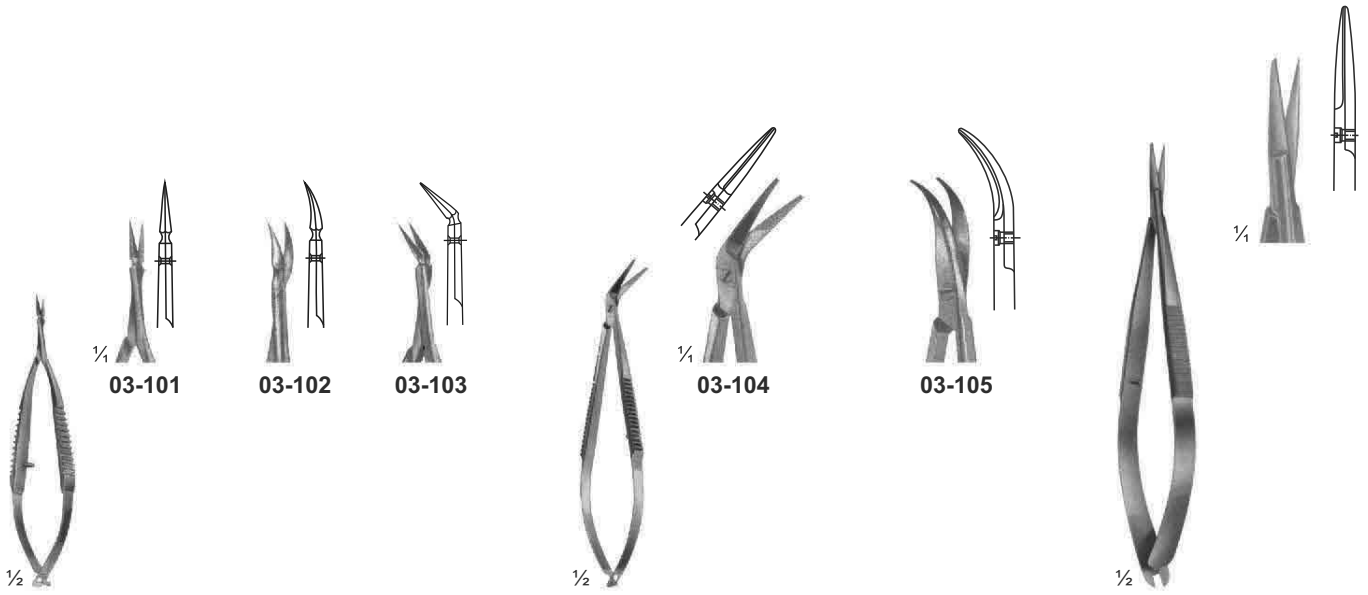

03-101 - 103
VANNAS
Size: 85 mm

03-104 - 105
CASTROVIEJO
Size: 95 mm

03-106
NOYES
Size: 125 mm

DENHART

INDUSTRY

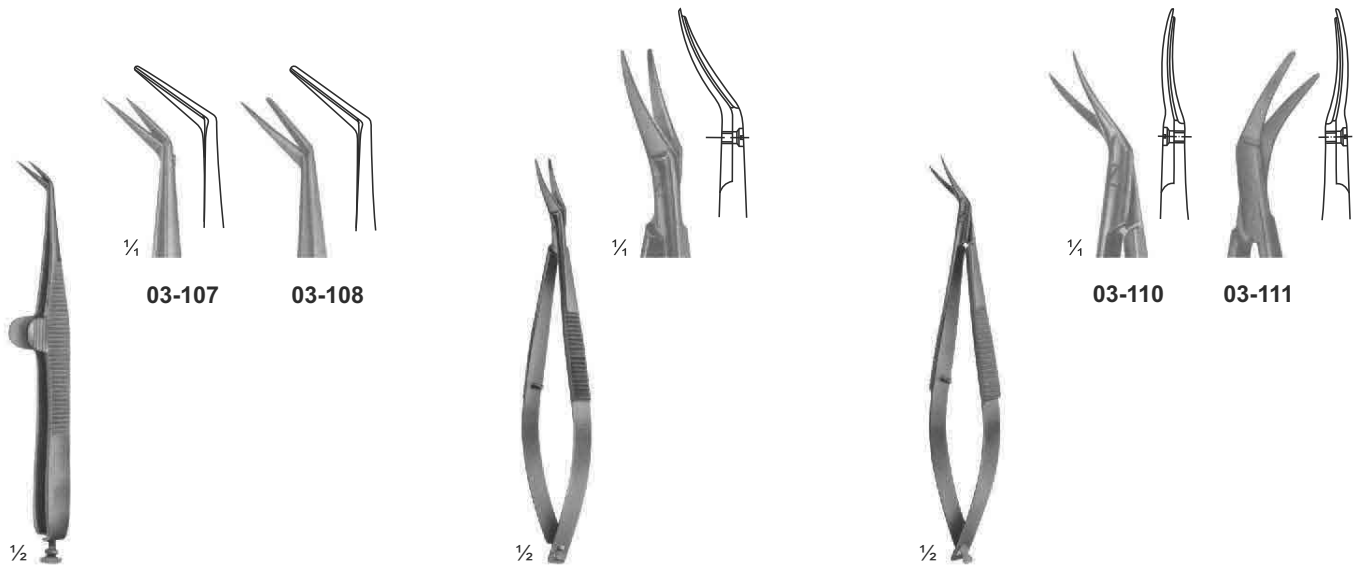

03-107 - 108
WECKER
Eye Scissor
Size: 110 mm

03-109
CASTROVIEJO
Eye Scissor
Size: 115 mm

03-110 - 111
CASTROVIEJO
Eye Scissor
Size: 110 mm

Micro Scissors, "Spring Type" Flat Handles

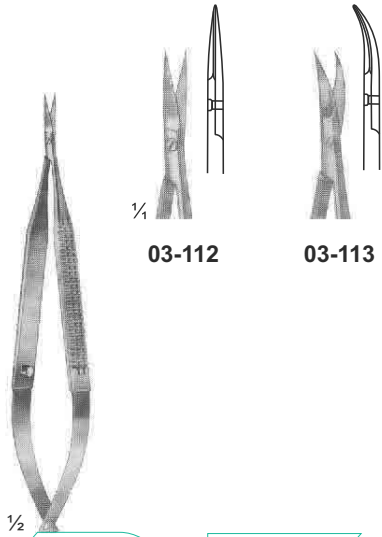

03-112
03-113

03-112 - 113
Size: 120 mm

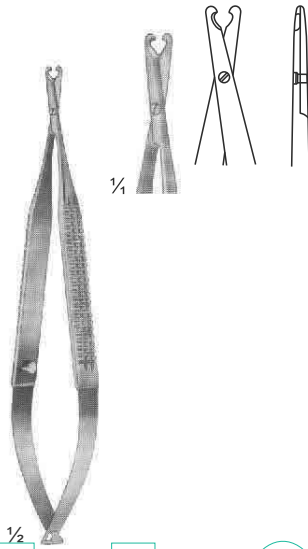

03-114

03-114
BIEMER
Vein-Scissor
Size: 130 mm

03-115
Size: 160 mm

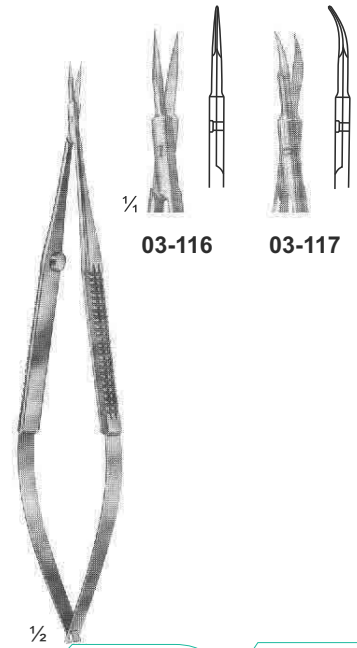

03-116
03-117

03-116 - 117
VANNAS
Size: 160 mm

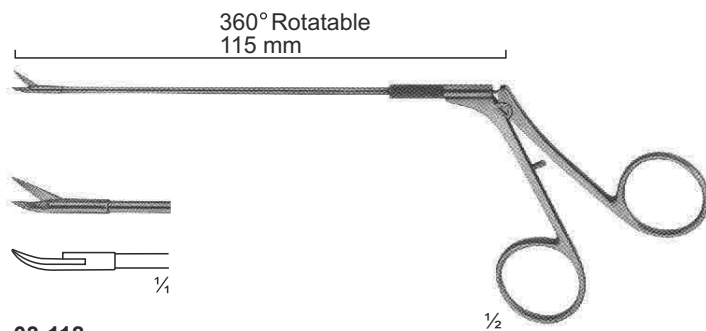

03-118
CASPAR
Micro Scissor Curved
Size: 115 mm

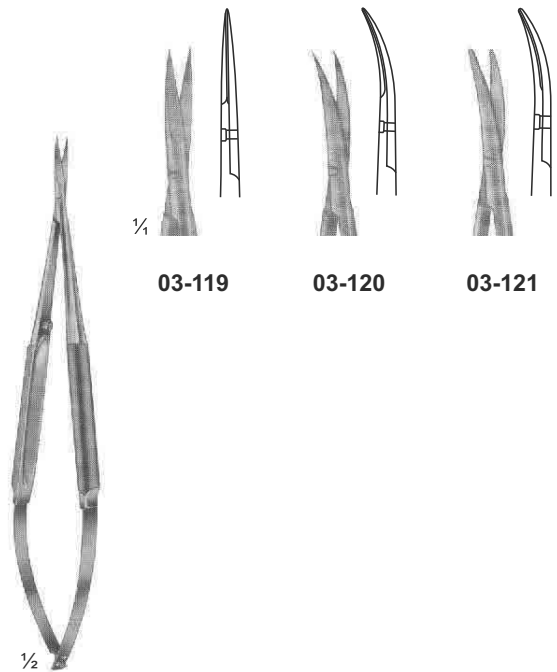

03-119
03-120
03-121

03-119 - 121
Micro Dissecting Scissor
Size: 145 mm

Micro Scissors, "Spring Type" Bayonet Shape

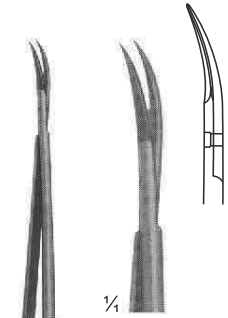

03-122
YASARGIL
Size: 245 mm

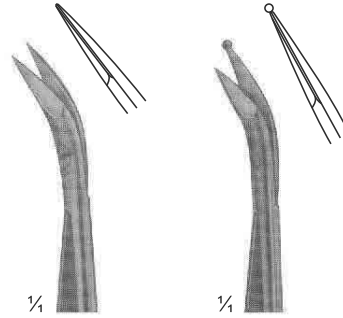

03-123

03-124



03-123 - 124
Laterally Angled
Size: 200 mm

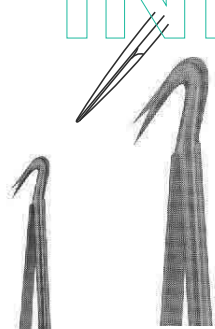

03-125
Laterally Angled
Size: 190 mm

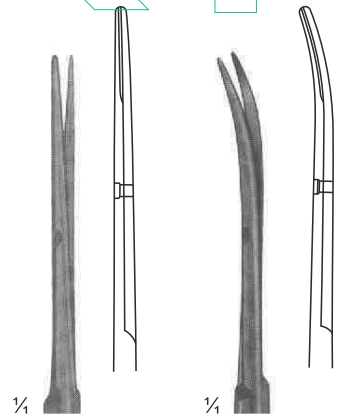

03-126

03-127



03-126 - 127
YASARGIL
Size: 225 mm

DENHART
INDUSTRY

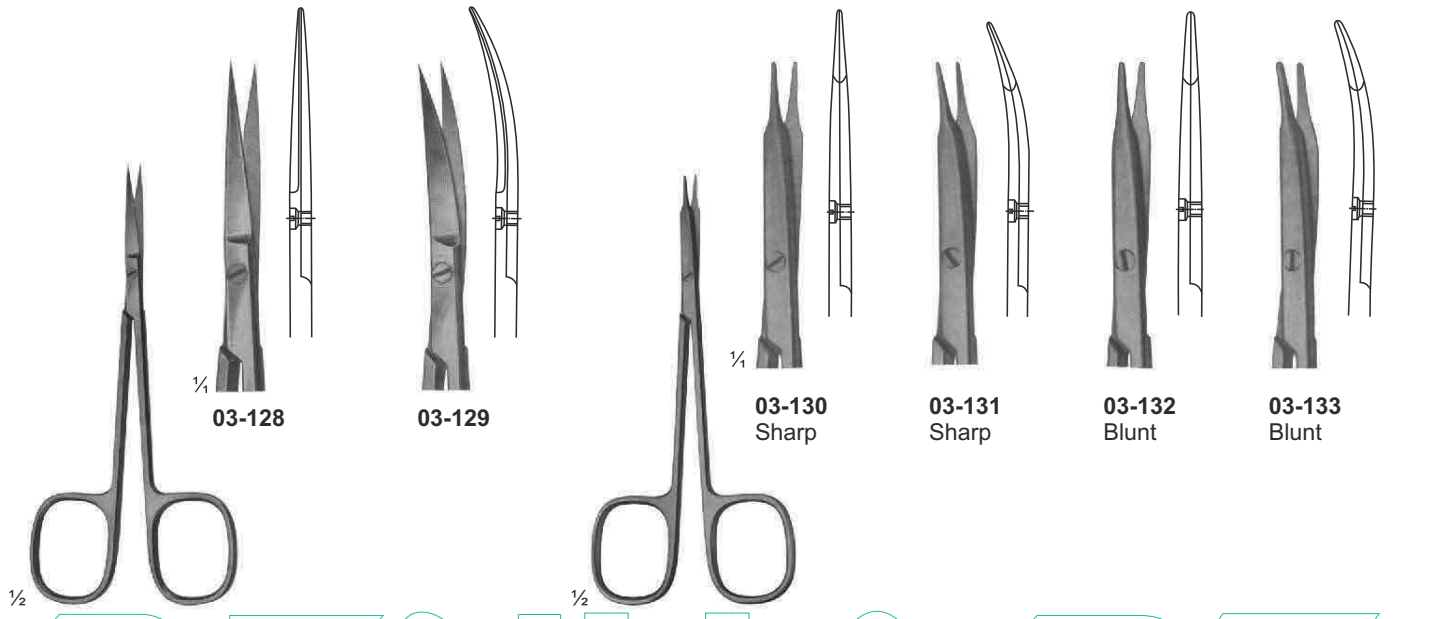

03-128

03-129

03-130
Sharp

03-131
Sharp

03-132
Blunt

03-133
Blunt

03-128 - 129
Size: 120 mm

03-130 - 133
STEVENS
Dissecting Scissors
Size: 115 mm

DENHART
INDUSTRY

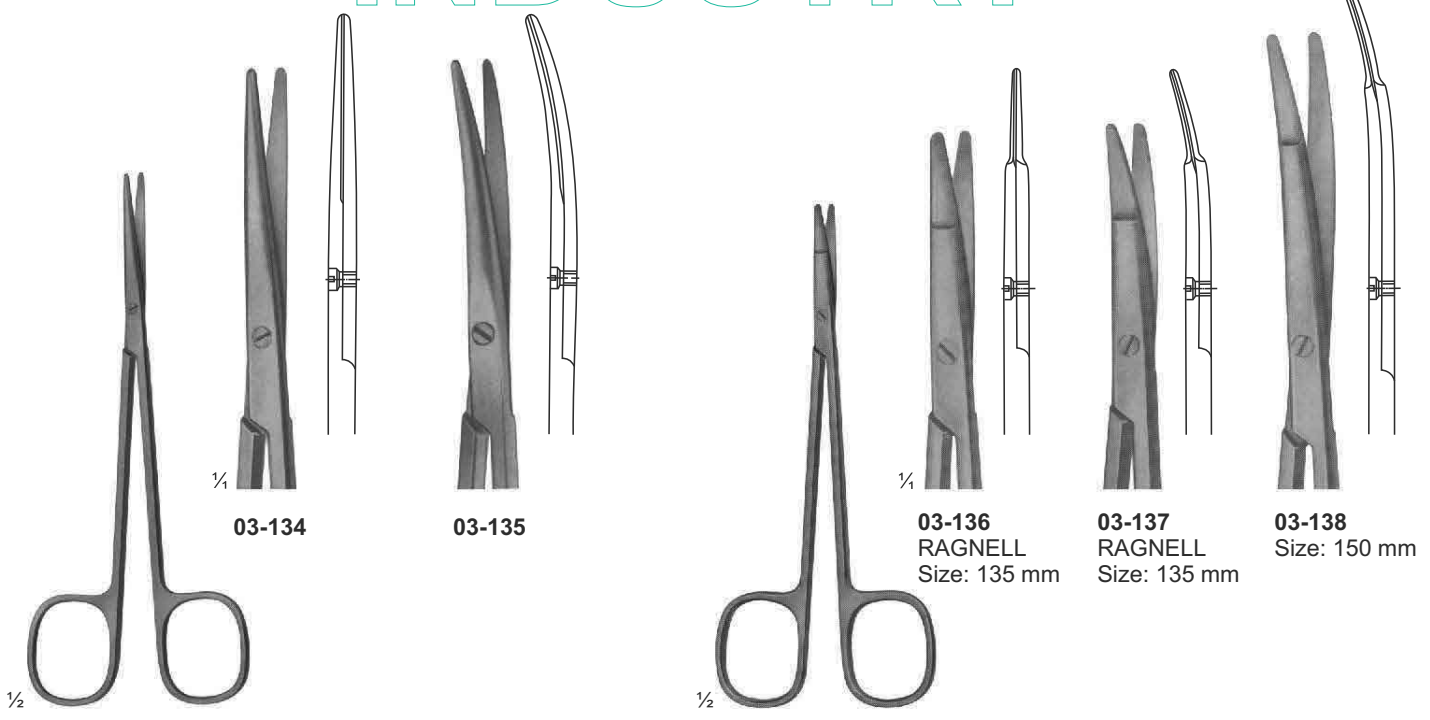

03-134

03-135

03-136
RAGNELL
Size: 135 mm

03-137
RAGNELL
Size: 135 mm

03-138
Size: 150 mm

03-134 - 135
METZENBAUM
Dissecting Scissors
Size: 145 mm

03-136 - 138
Special flat points for
dissecting and
undermining the skin
Size: 145 mm

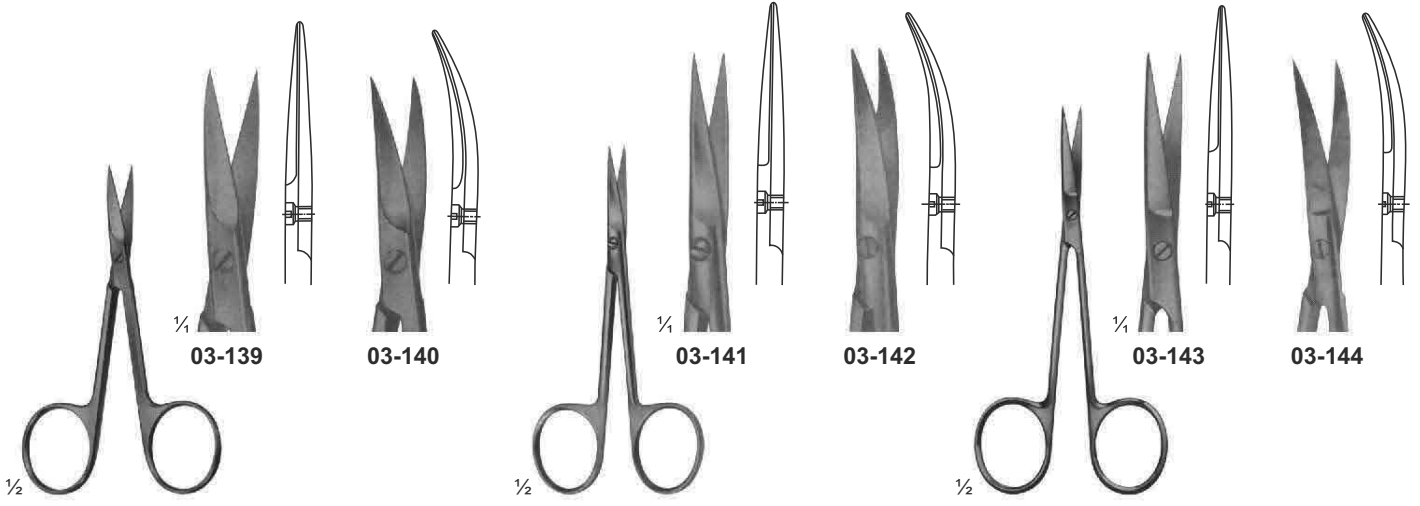

03-139 - 140
Size: 90 mm

03-141 - 142
Size: 95 mm

03-143 - 144
Size: 105 mm

DENHART

INDUSTRY



03-145 - 146
Size: 120 mm

03-147 - 148
Size: 115 mm



3/4

03-149 - 151
Size: 120 mm

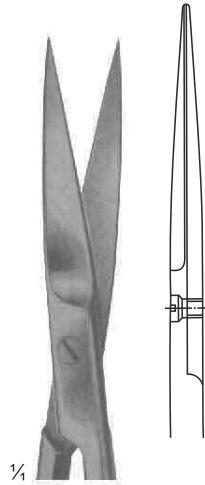

1/4

03-149

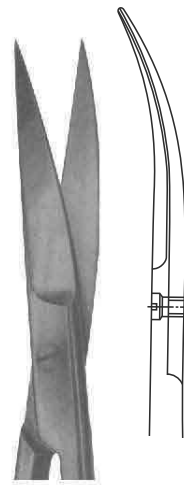

03-150

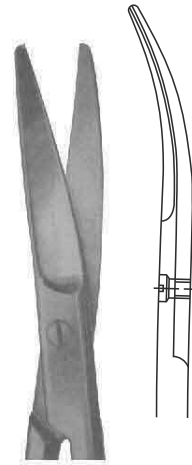

03-151

DENHART

INDUSTRY



3/4

03-152 - 155
Size: 130 mm

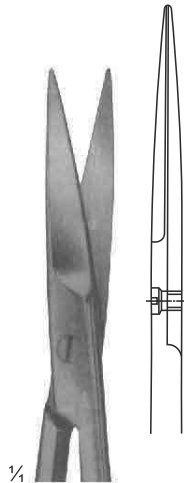

1/4

03-152

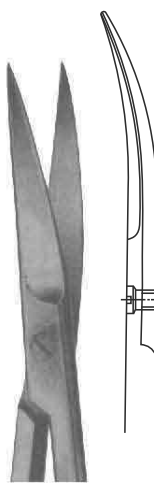

03-153

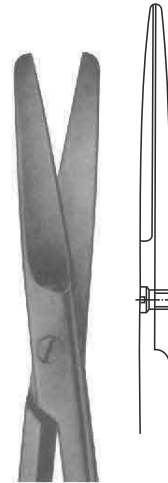

03-154

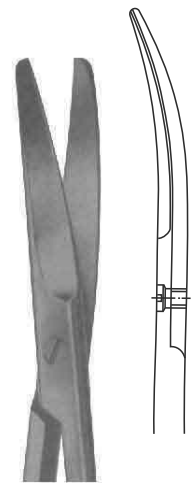

03-155

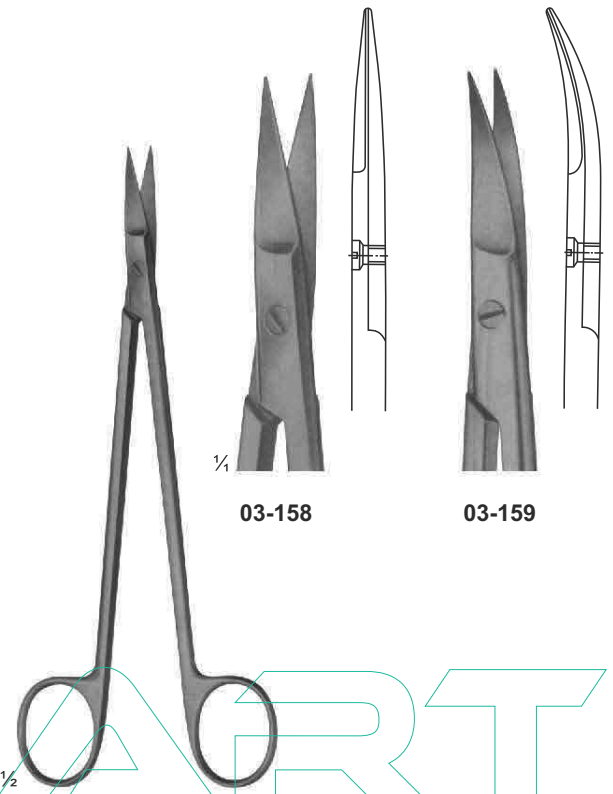
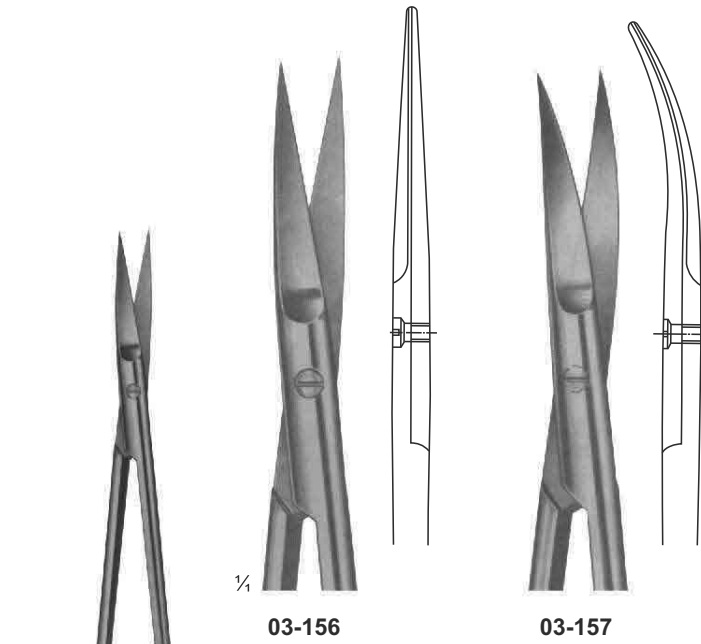

03-156 - 157
JOSEPH
Size: 150 mm

03-158 - 159
KELLY
Size: 175 mm

DENHART
INDUSTRY

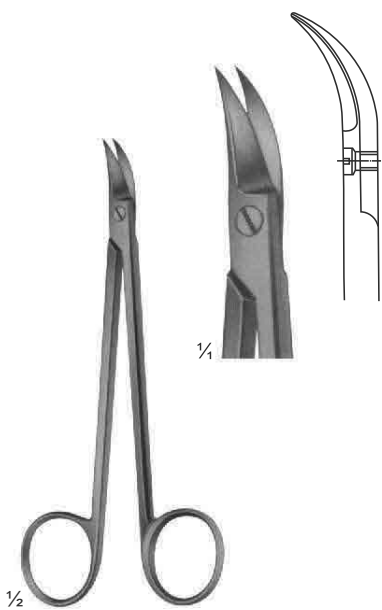

03-160
QUINBY
Size: 130 mm

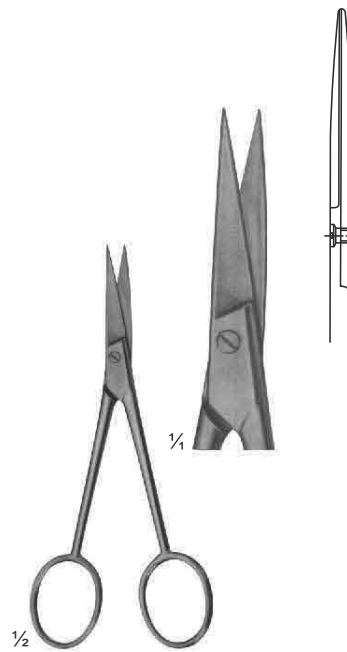

03-161
Size: 110 mm

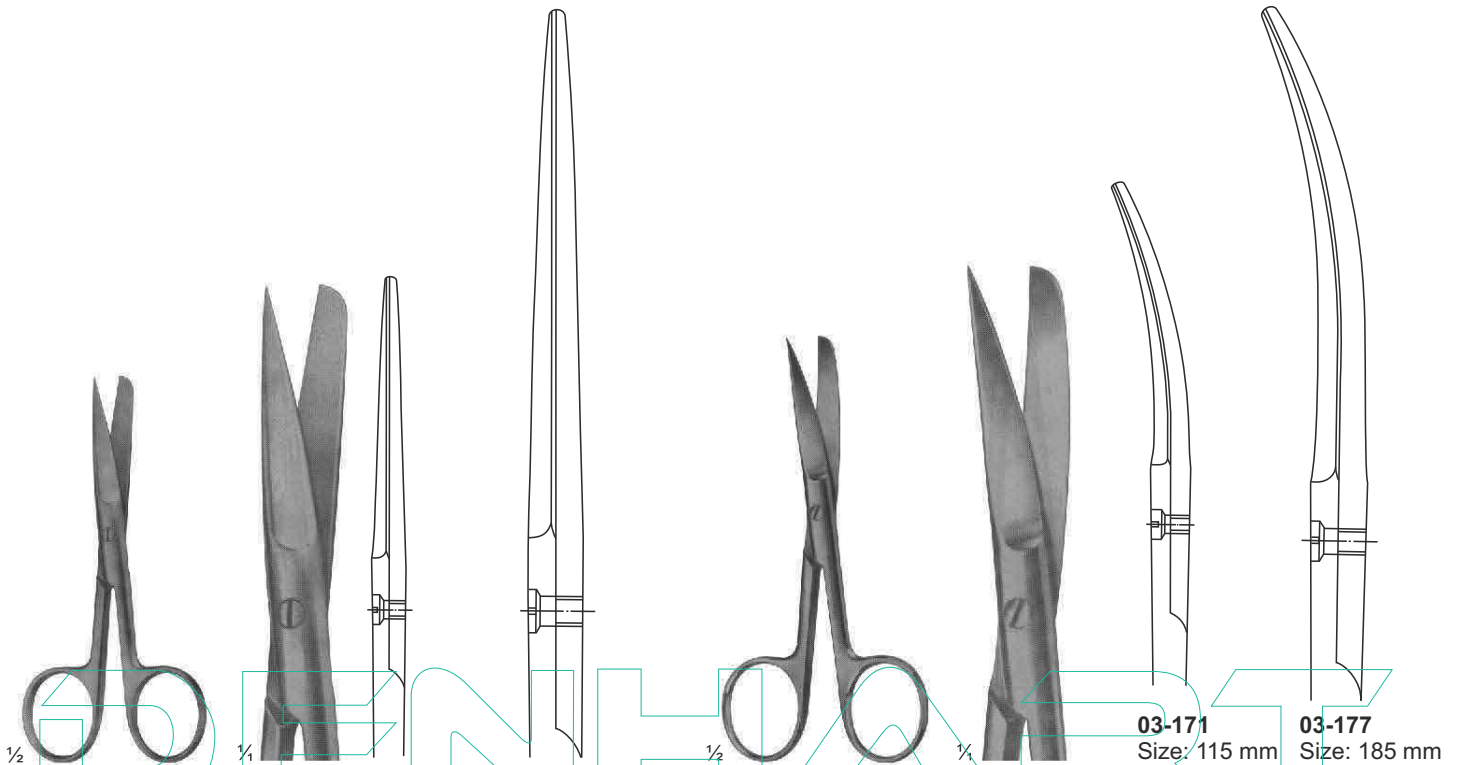

03-162 - 170 (Standard Types) Size: 105 mm Size: 200 mm
03-162 (105 mm)
03-163 (115 mm)
03-164 (130 mm)
03-165 (145 mm)
03-166 (150 mm)
03-167 (165 mm)
03-168 (175 mm)
03-169 (185 mm)
03-170 (200 mm)

03-171 - 177 (Standard Types)
03-171 (115 mm)
03-172 (130 mm)
03-173 (145 mm)
03-174 (150 mm)
03-175 (165 mm)
03-176 (175 mm)
03-177 (185 mm)

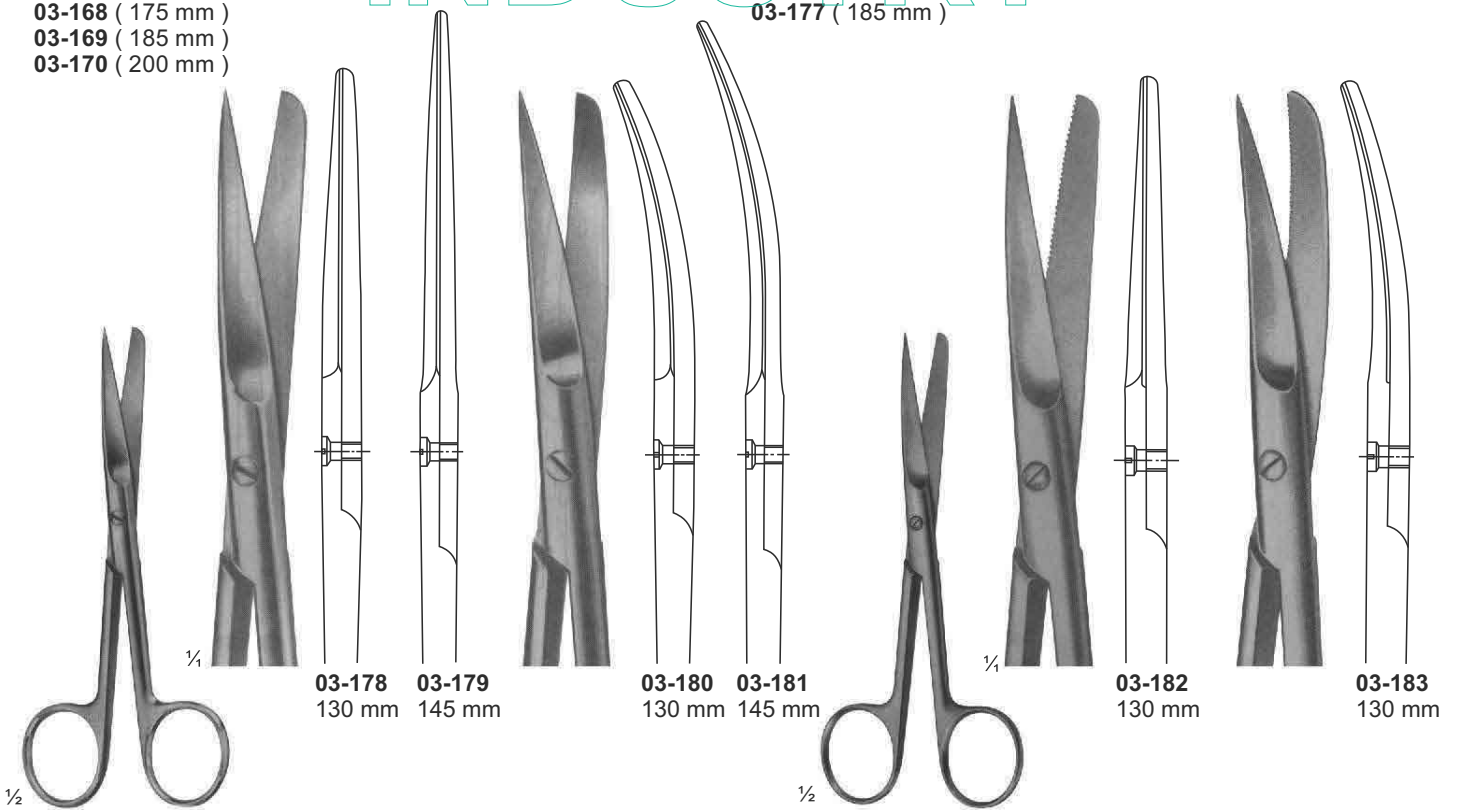

03-178 - 181
Slender Types

03-182 - 183
For Wound Edges
1 Blade Serrated

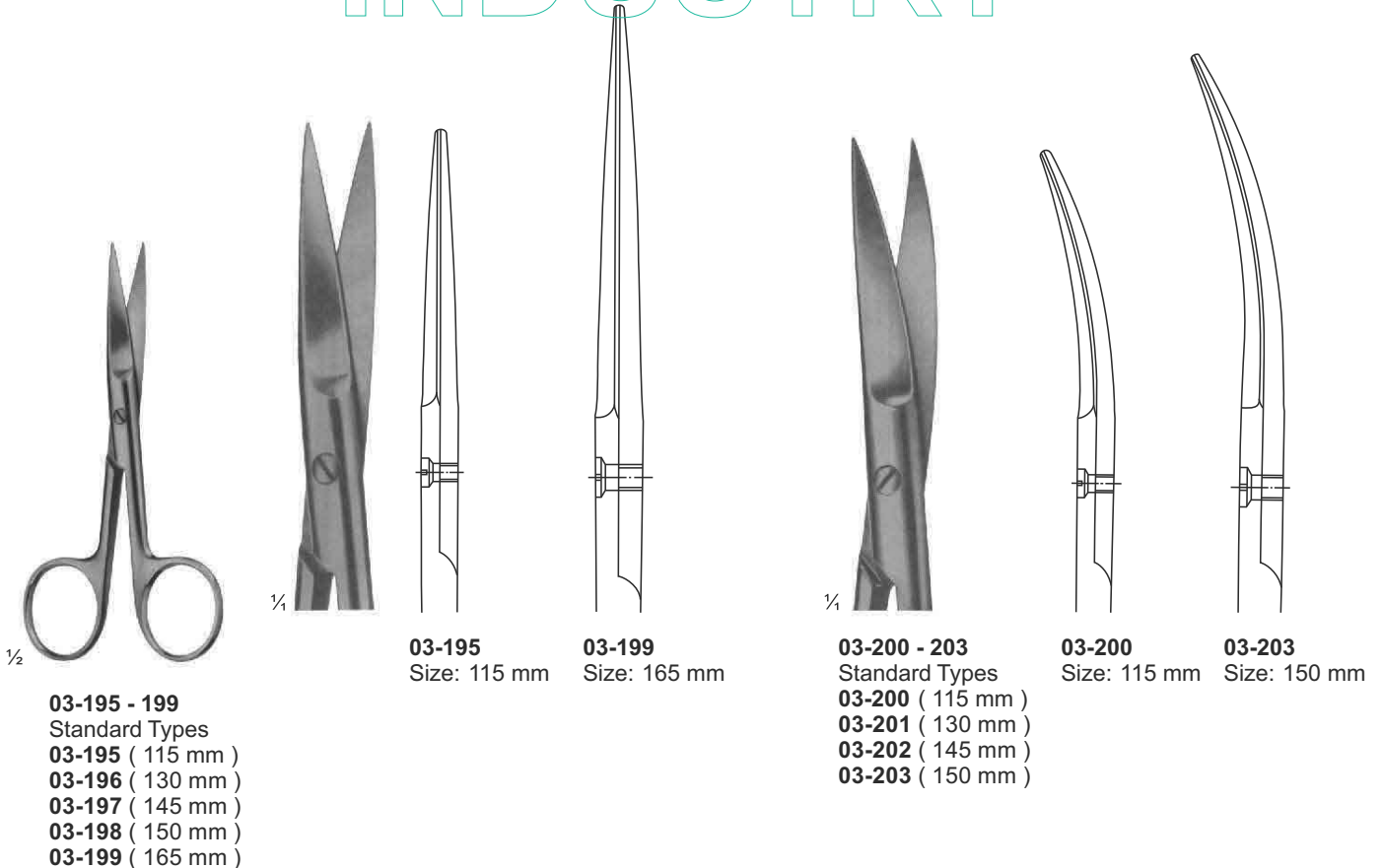
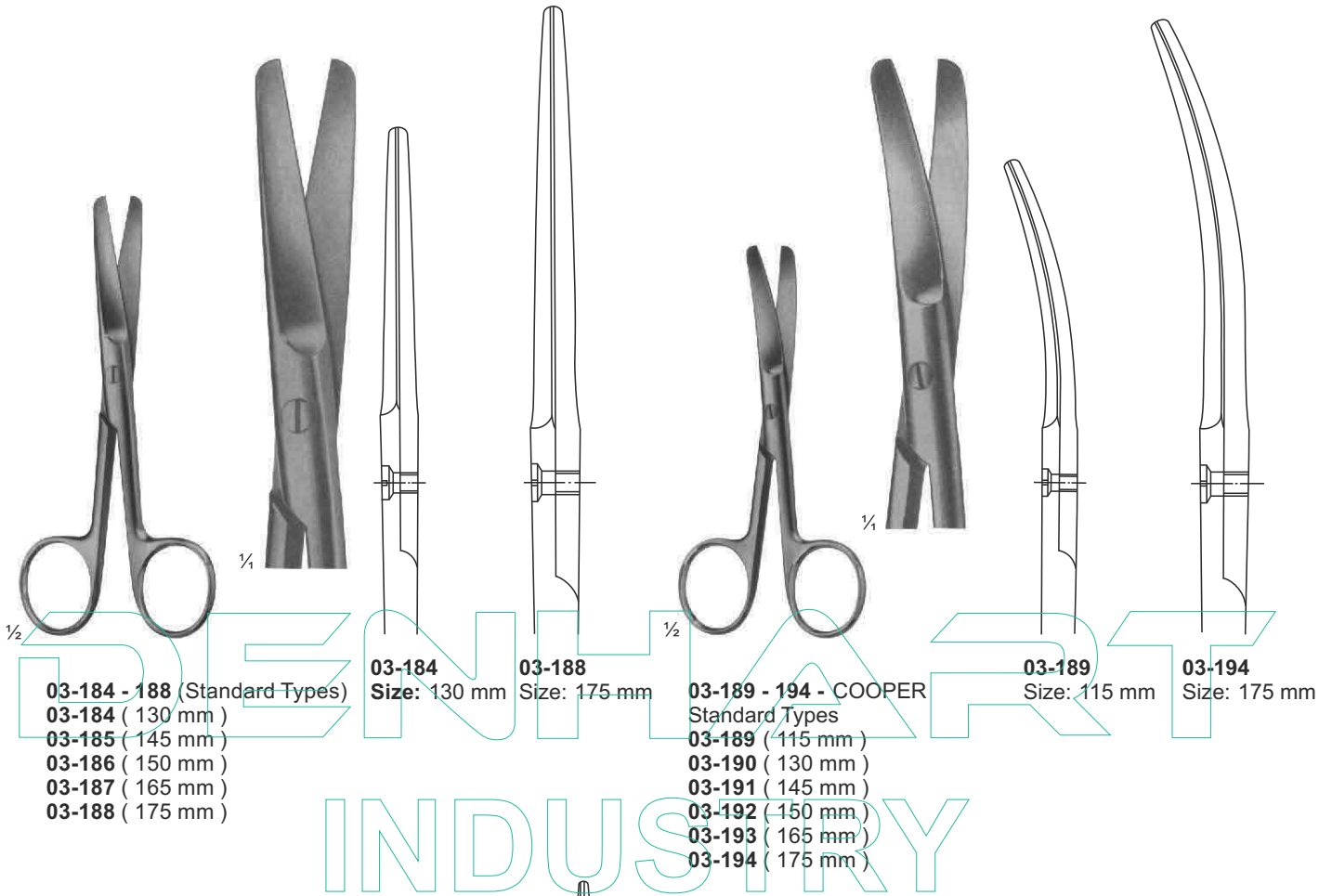

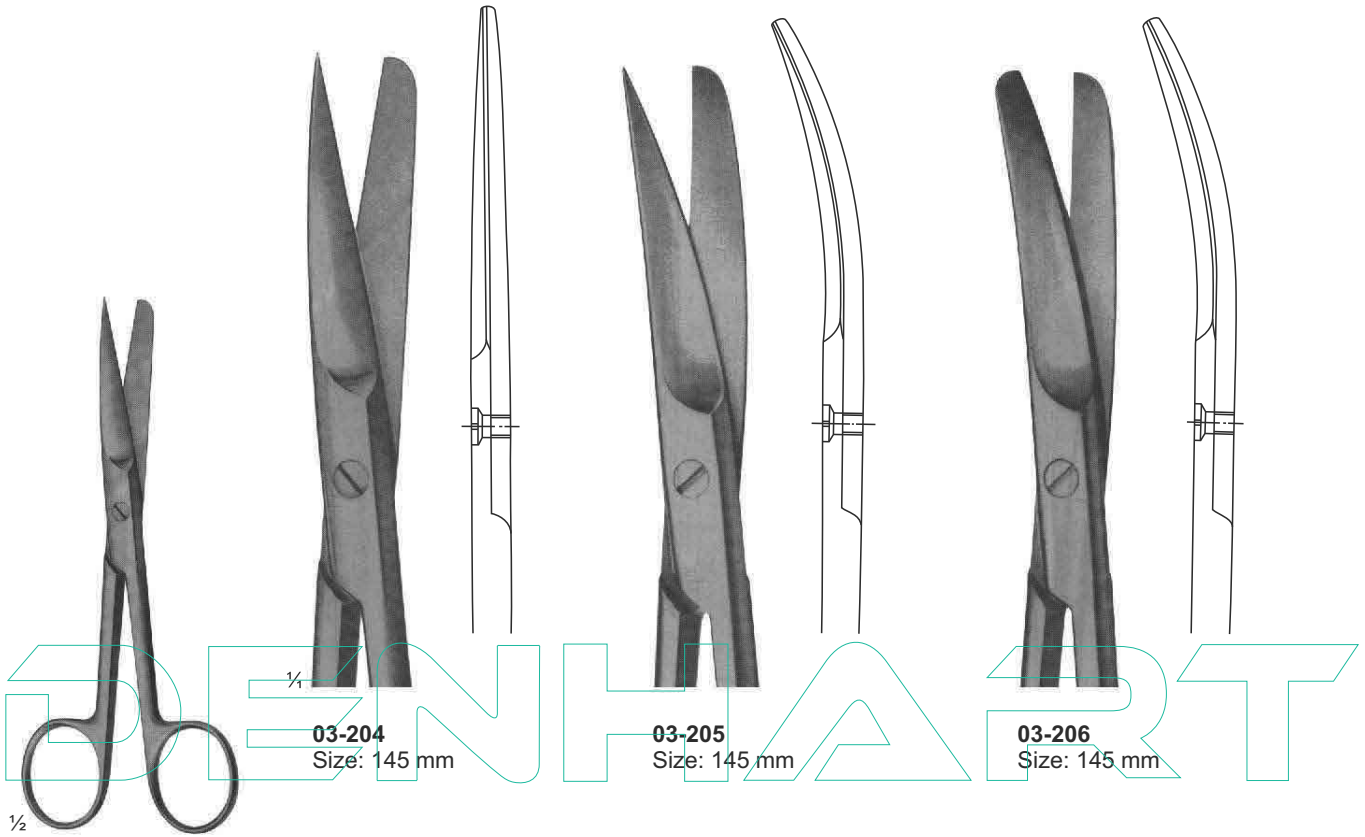

03-204
Size: 145 mm

03-205
Size: 145 mm

03-206
Size: 145 mm

03-204 - 206
DEAVER
With flat lock

INDUSTRY

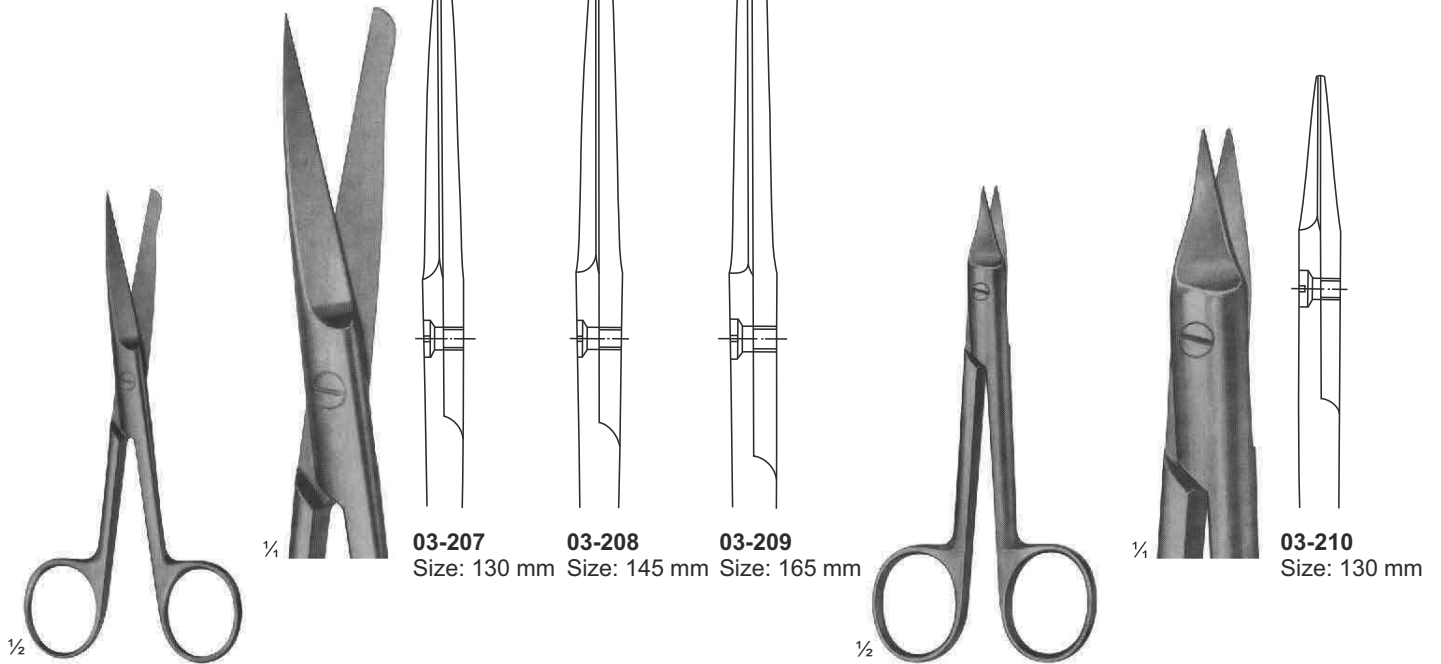

03-207
Size: 130 mm

03-208
Size: 145 mm

03-209
Size: 165 mm

03-210
Size: 130 mm

03-207 - 209
Incision Scissors

03-210
SYSTRUNK
Nail Splitting Scissors

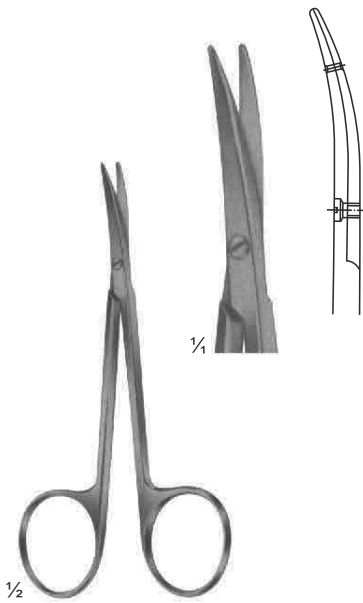

03-211
LITTLER
Dissecting Scissors
Tips with eye for suture
Size: 115 mm

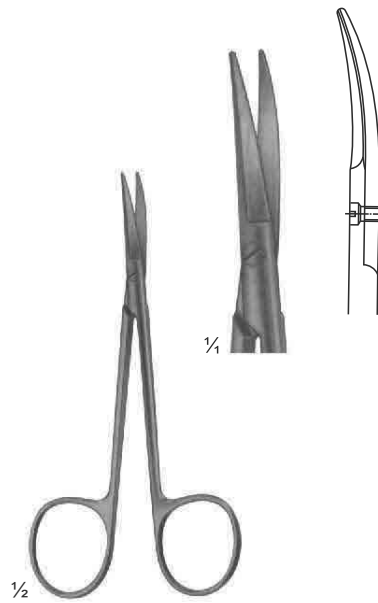

03-212
COTTLE
Bulldog Scissors
Size: 115 mm

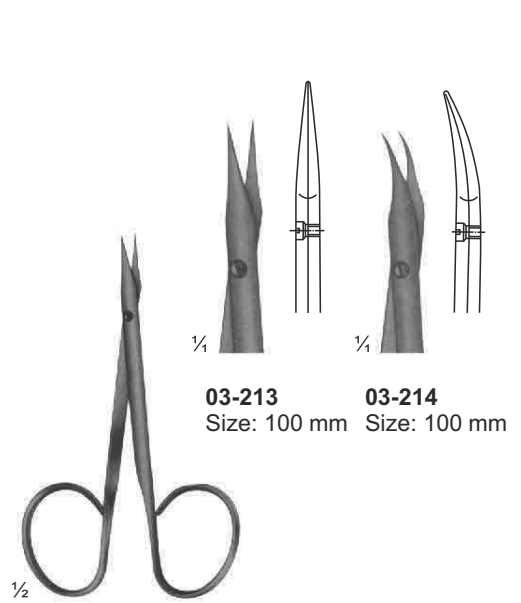

03-213 **03-214**
Size: 100 mm Size: 100 mm

03-213 - 214
STEVENS
Vessel and tendon Scissors
Size: 100 mm

INDUSTRY

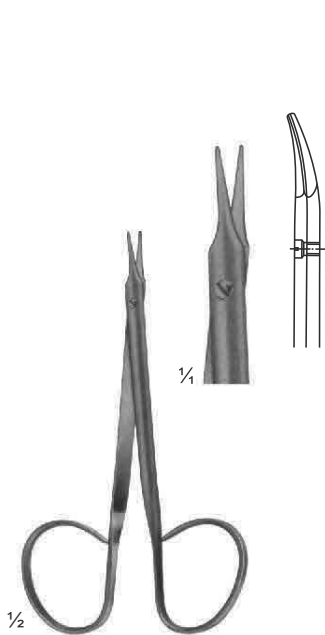

03-215
STEVENS
Fine Dissecting Scissors
Size: 110 mm

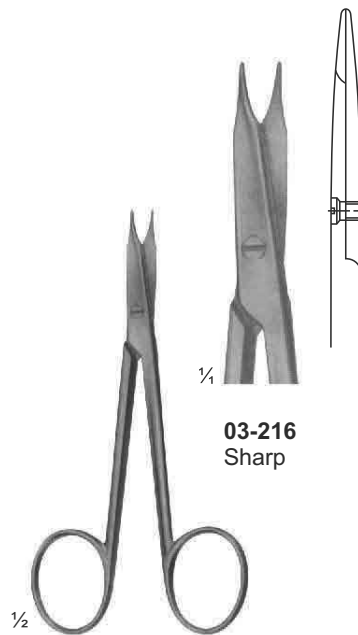

03-216 - 219
STEVENS
Vessel and tendon Scissors
Size: 110 mm

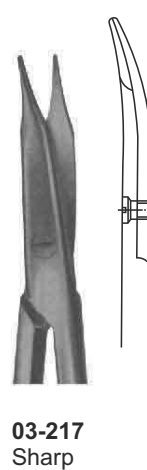

03-217
Sharp

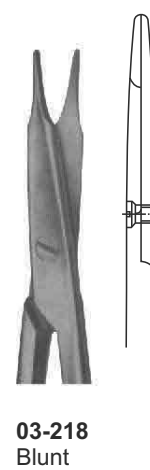

03-218
Blunt

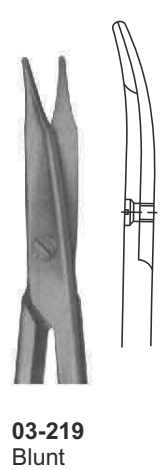

03-219
Blunt

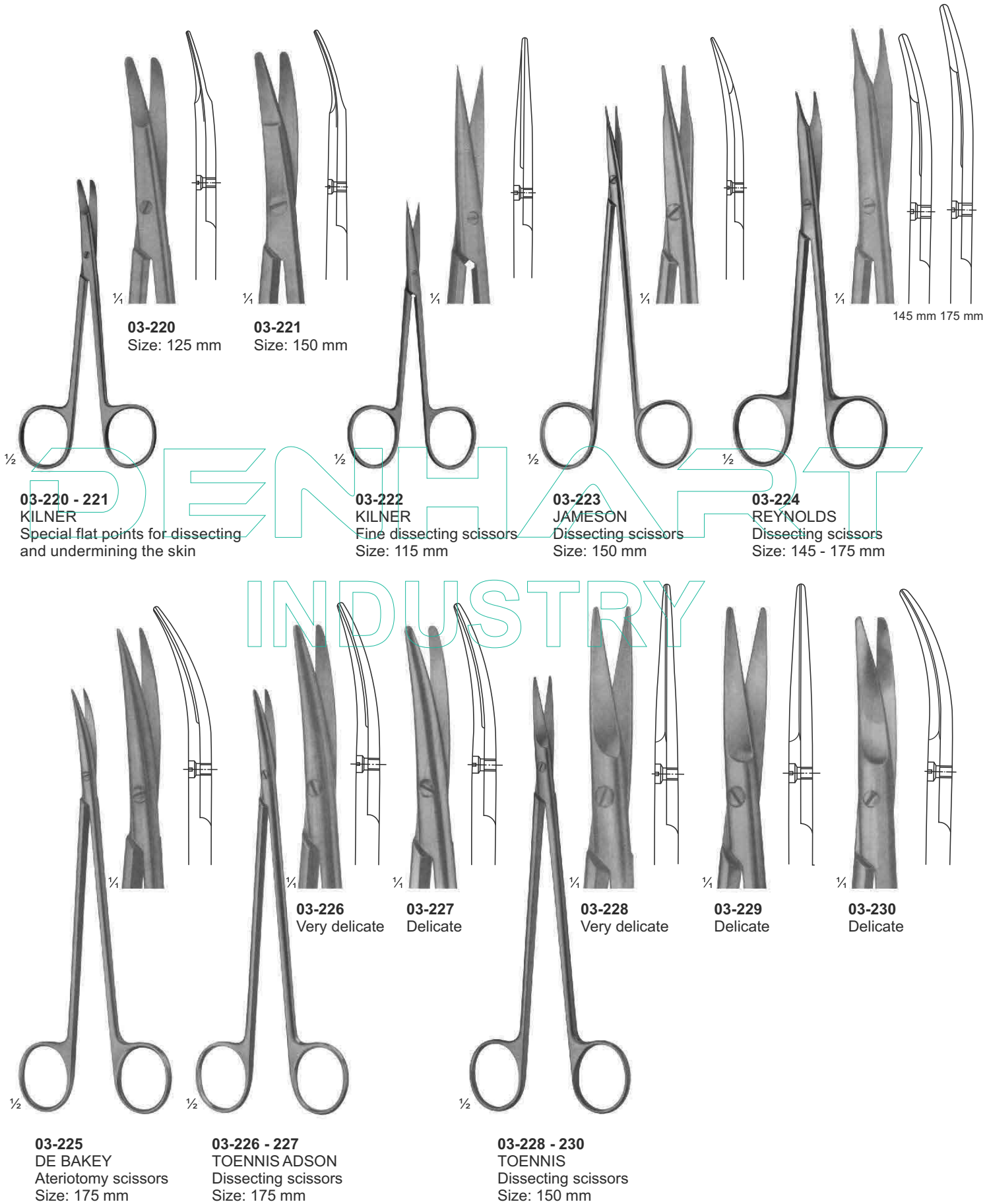

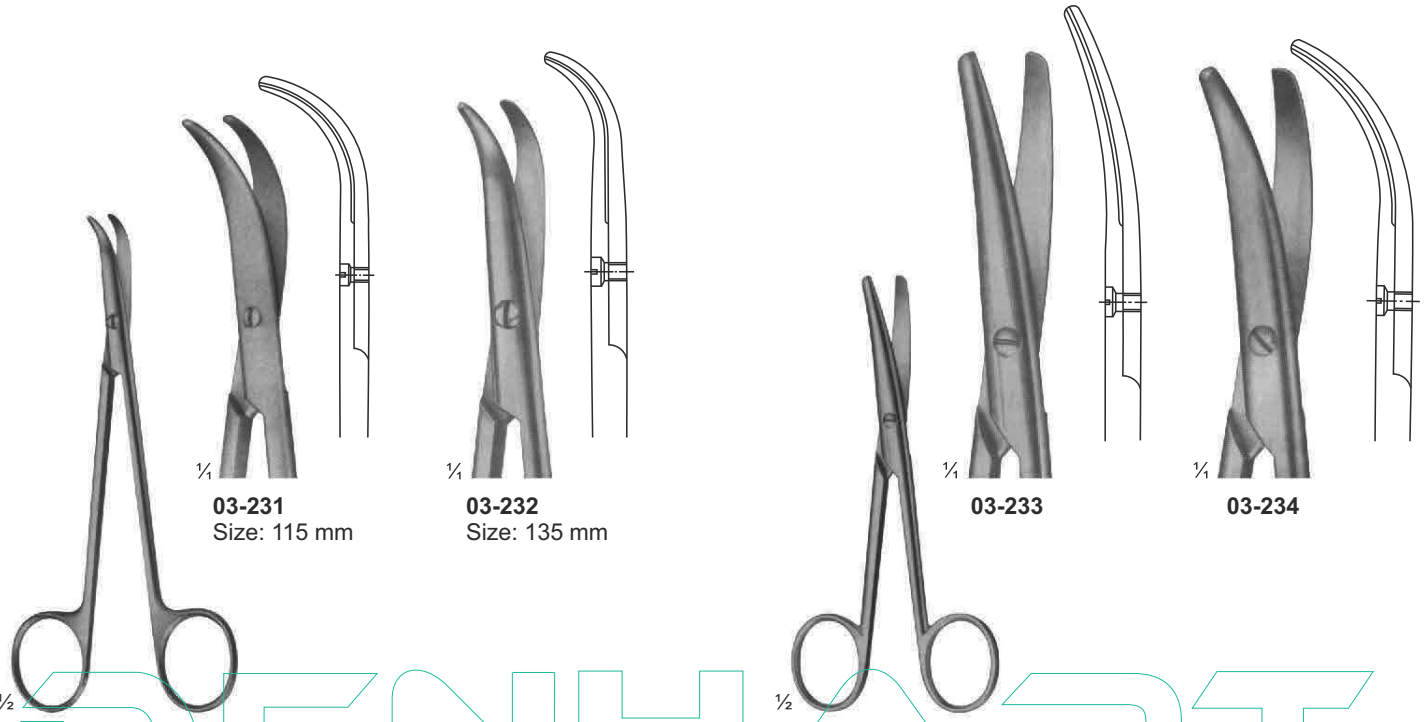

03-231
Size: 115 mm

03-232
Size: 135 mm

03-233

03-234

03-231 - 232
FOMON
Lower lateral scissors

03-233 - 234
LANDOLT
Enucleation scissors
Size: 120 mm

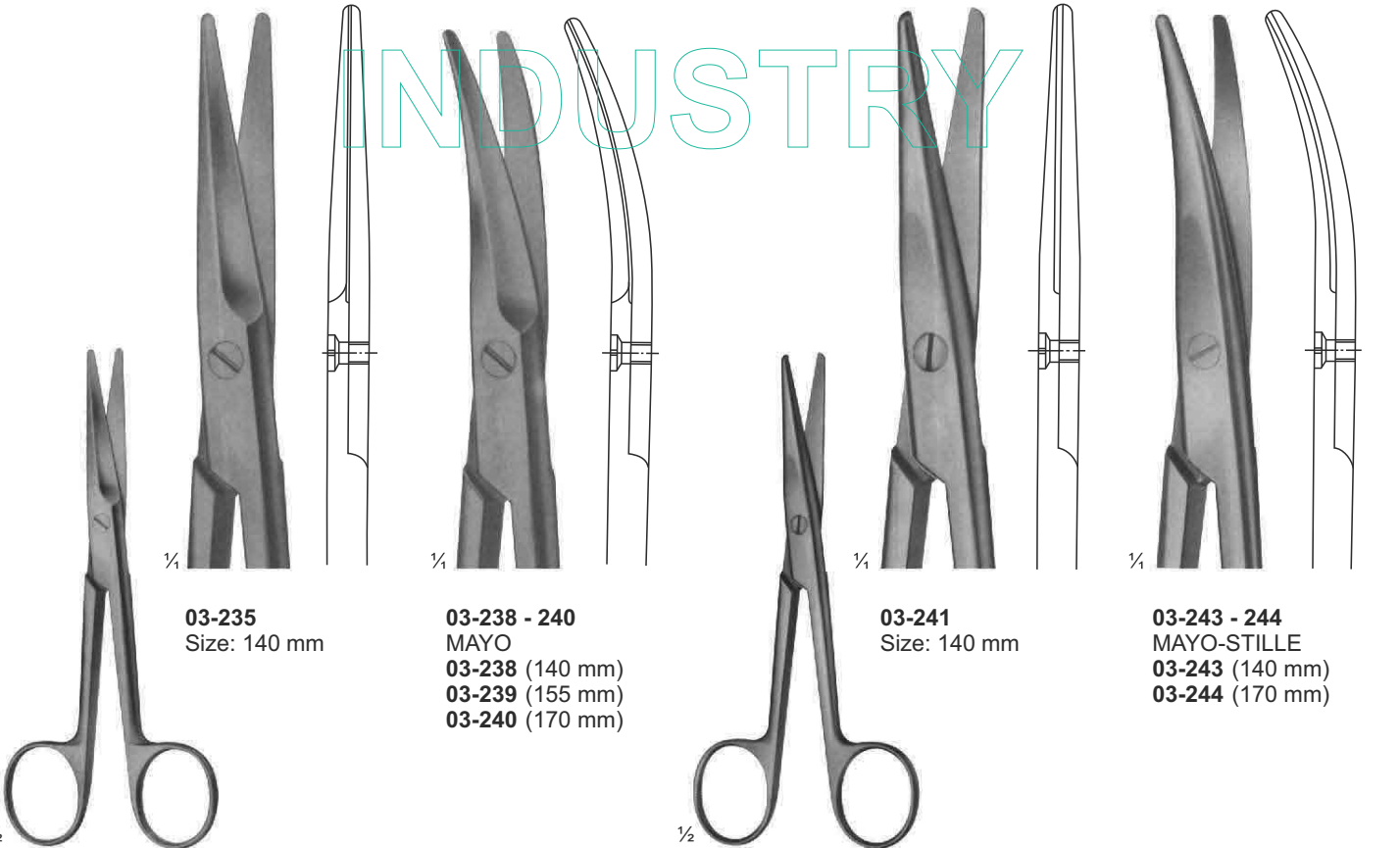

03-235
Size: 140 mm

03-238 - 240
MAYO
03-238 (140 mm)
03-239 (155 mm)
03-240 (170 mm)

03-241
Size: 140 mm

03-243 - 244
MAYO-STILLE
03-243 (140 mm)
03-244 (170 mm)

03-235 - 237
MAYO
03-235 (140 mm)
03-236 (155 mm)
03-237 (170 mm)

03-241 - 242
MAYO-STILLE
03-241 (140 mm)
03-242 (170 mm)

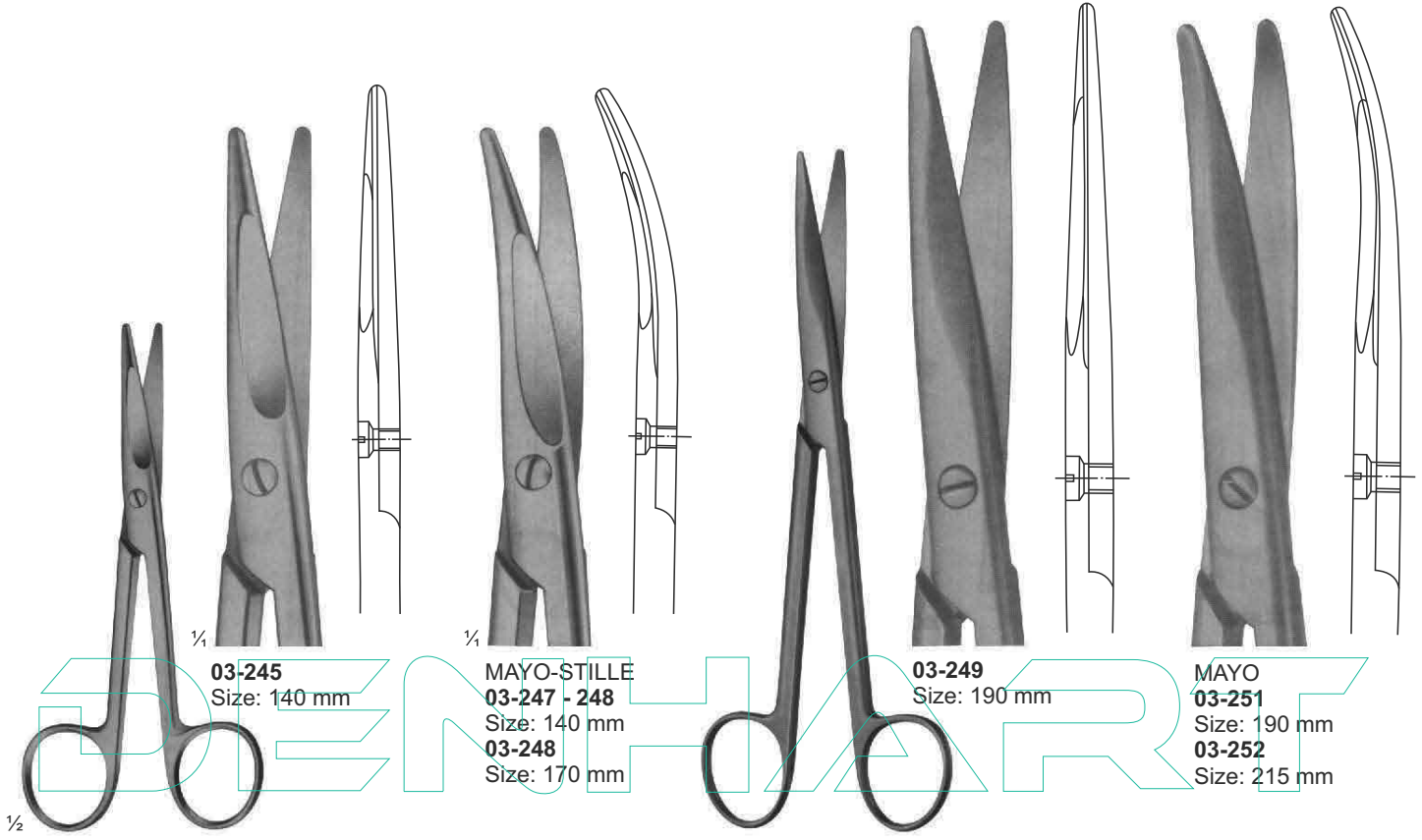

03-245
Size: 140 mm

MAYO-STILLE
03-247 - 248
Size: 140 mm
03-248
Size: 170 mm

03-249
Size: 190 mm

MAYO
03-251
Size: 190 mm
03-252
Size: 215 mm

$\frac{1}{2}$
03-245 - 246
MAYO-STILLE
With chamfered blades
03-245 (140 mm)
03-246 (170 mm)

MAYO
With chamfered blades
03-249 (190 mm)
03-250 (215 mm)

INDUSTRY

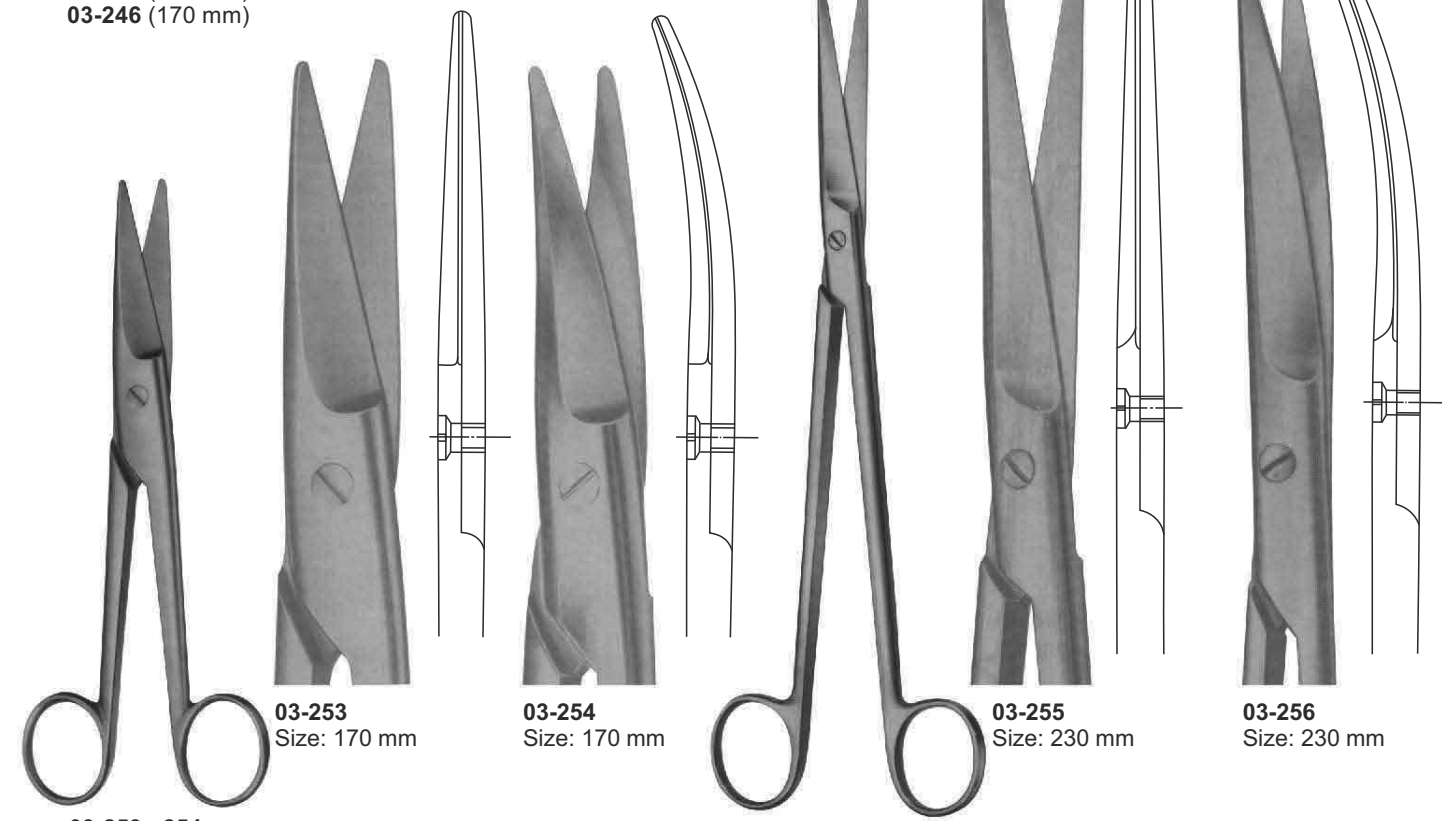

03-253
Size: 170 mm

03-254
Size: 170 mm

03-255
Size: 230 mm

03-256
Size: 230 mm

03-253 - 254
MAYO-NOBLE
Broad pattern

03-255 - 256
MAYO-HARRINGTON

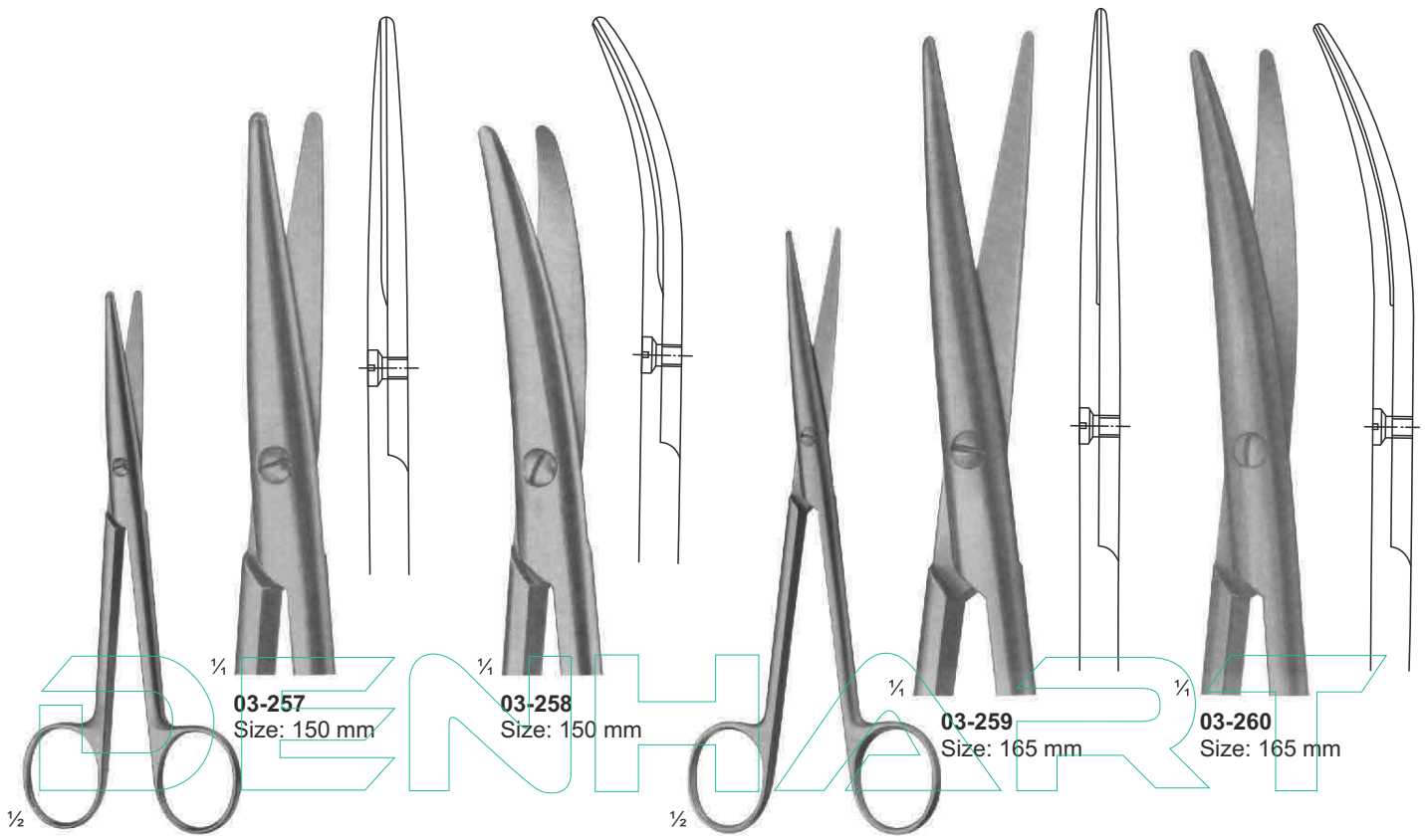

03-257
Size: 150 mm

03-258
Size: 150 mm

03-259
Size: 165 mm

03-260
Size: 165 mm

03-257 - 258
STILLE
Size: 150 mm

03-259 - 260
LEXER
Narrow
Size: 165 mm

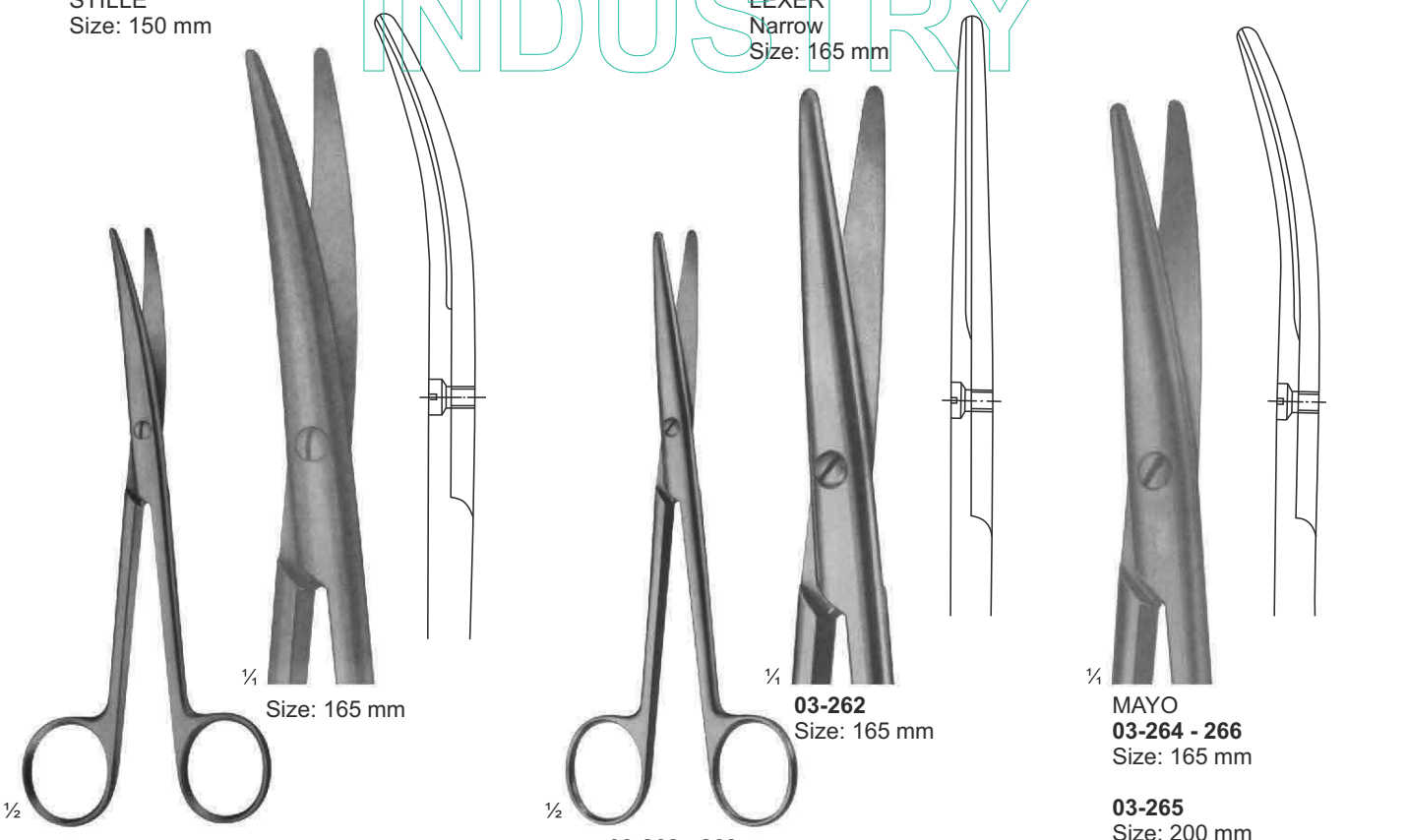

Size: 165 mm

03-262
Size: 165 mm

MAYO
03-264 - 266
Size: 165 mm

03-261
MAYO-LEXER
Standard

03-262 - 263
MAYO
03-262 (165 mm)
03-263 (200 mm)

03-265
Size: 200 mm
03-266
Size: 210 mm

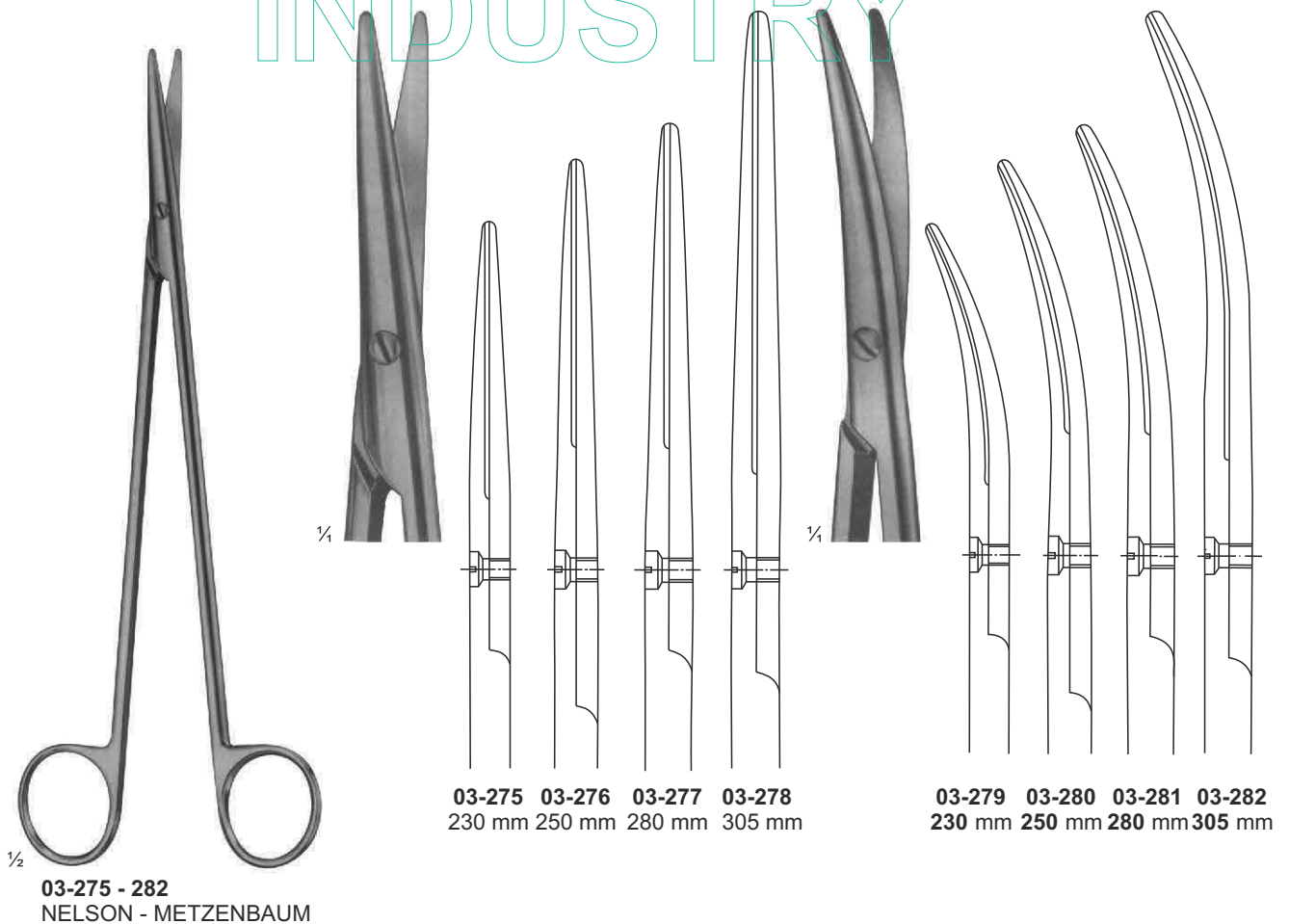
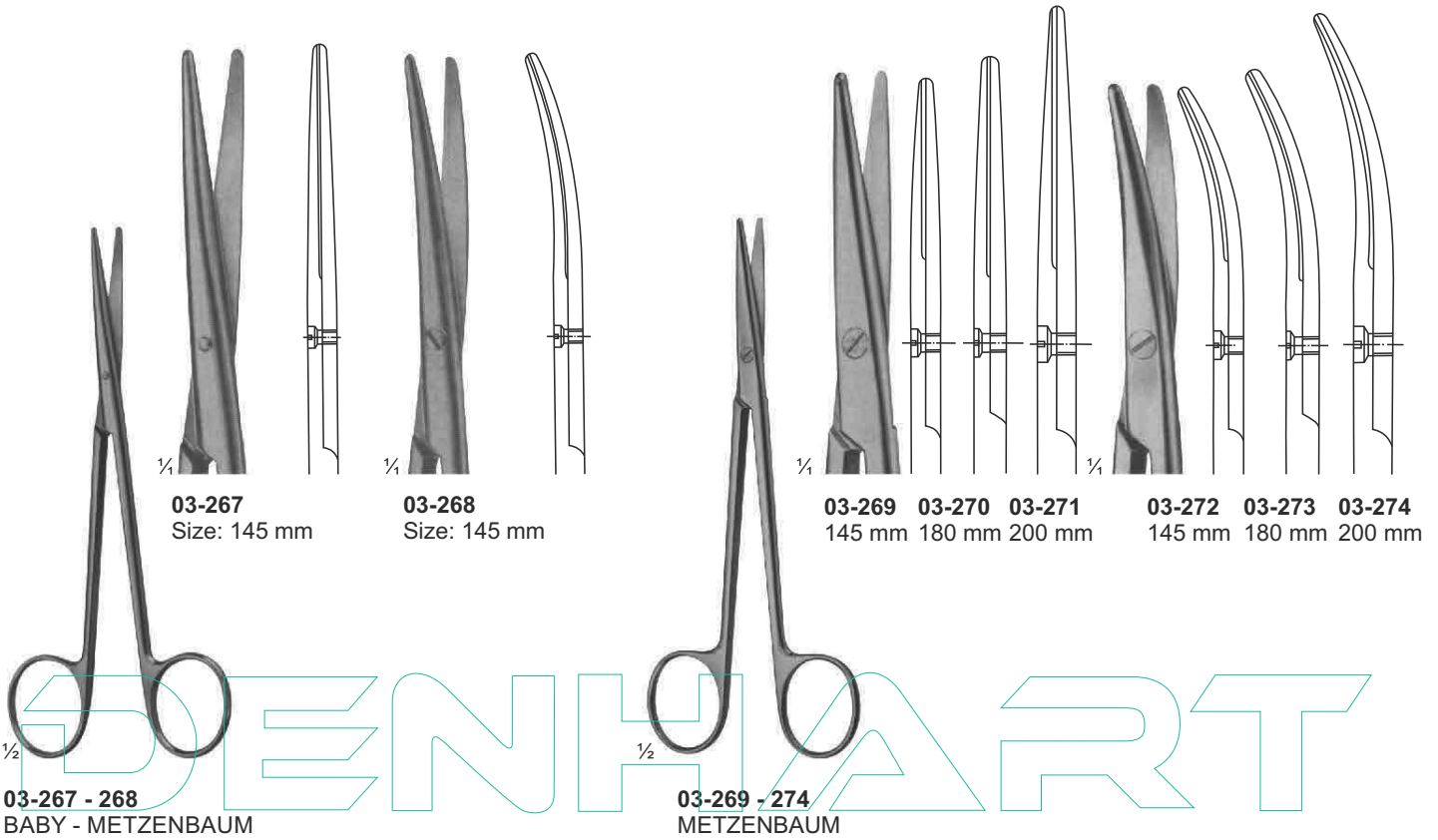

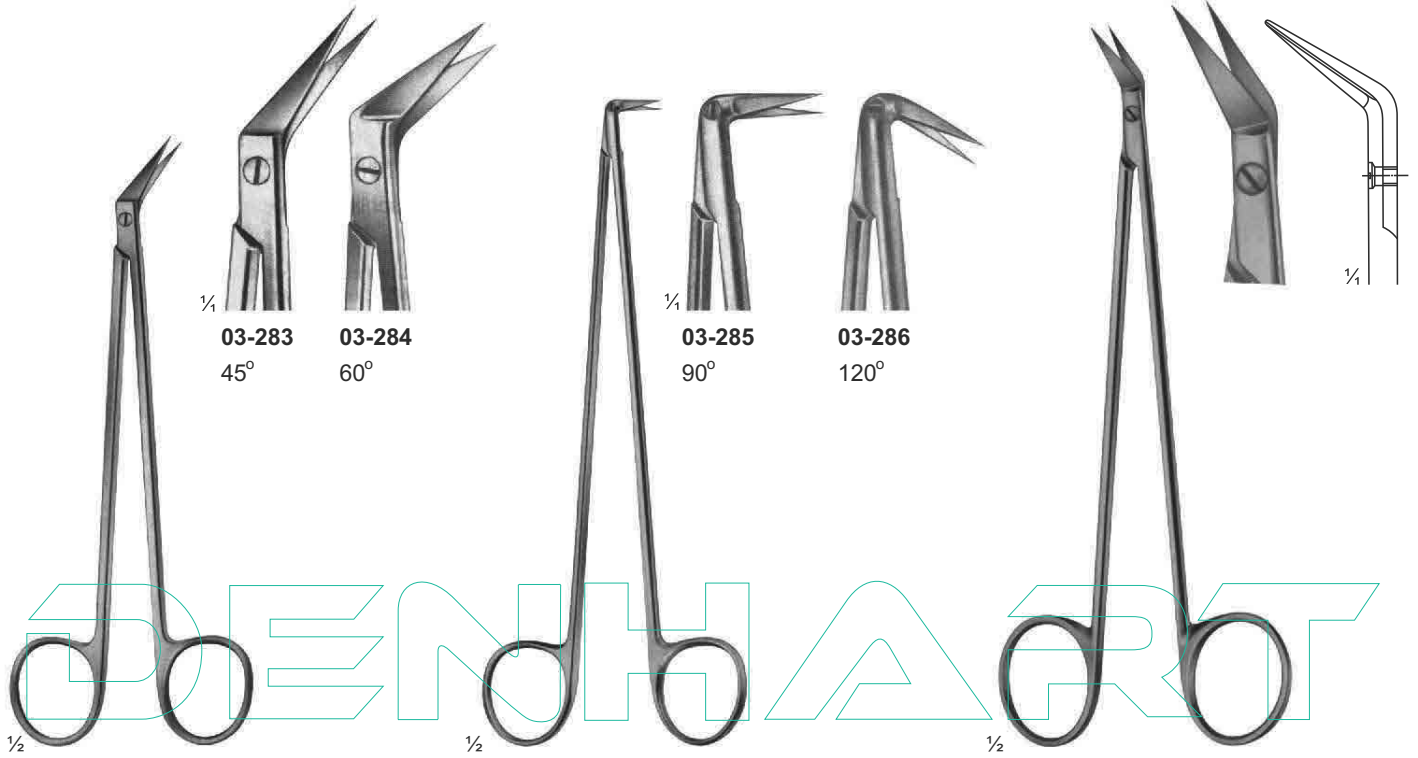

03-283 - 284
DE BAKEY
Size: 155 mm

03-285 - 286
DIETRICH
Size: 170 mm

03-287
POTTS-SMITH
Size: 180 mm

INDUSTRY

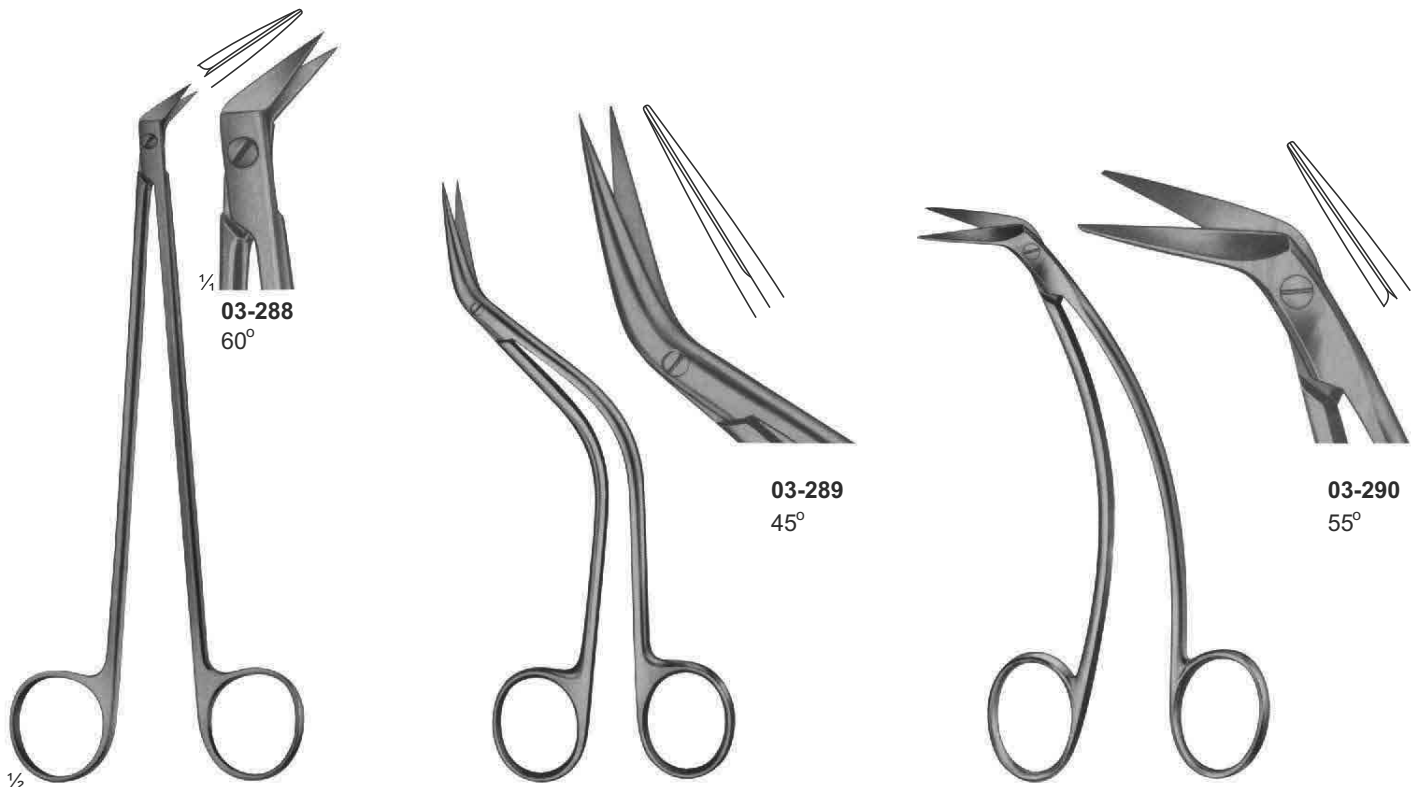

03-288
POTTS-SMITH
Size: 180 mm

03-289
DEBAKEY
Size: 155 mm

03-290
FAVOLORO
Size: 140 mm



03-291
OLIVECRONA
Dura Scissors

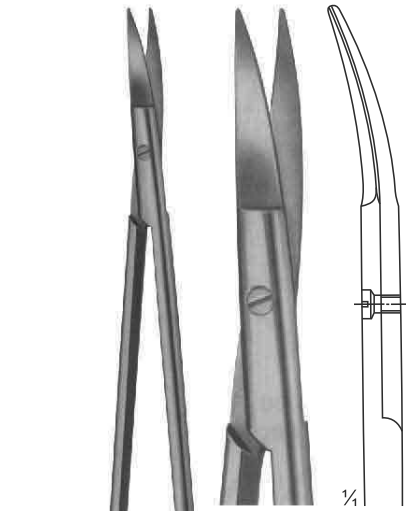

03-292
STRULLY
Pointed
Size: 220 mm

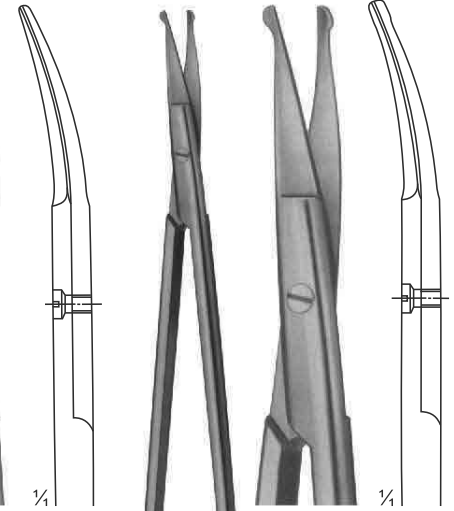

03-293
STRULLY
Probe Pointed
Size: 220 mm

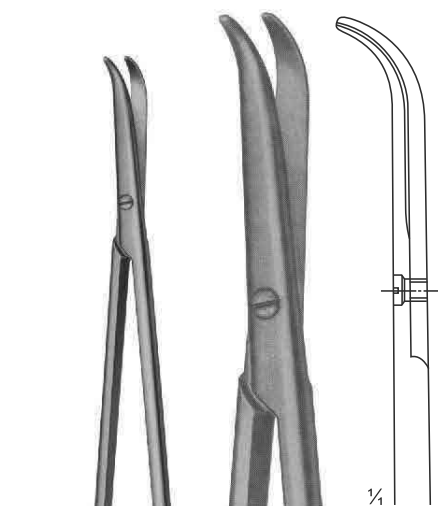

03-294
THOREK
Size: 180 mm

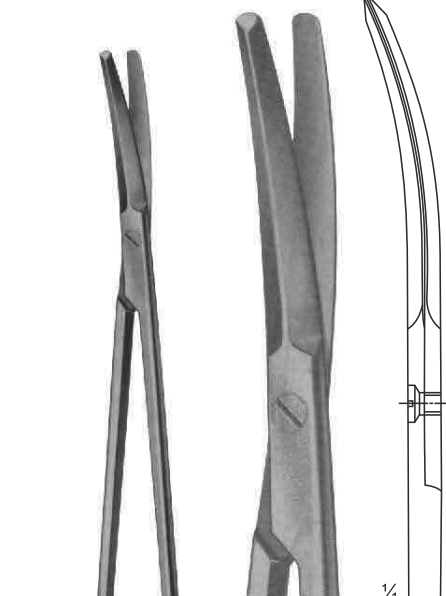

03-295
POTTS-SMITH
Size: 190 mm

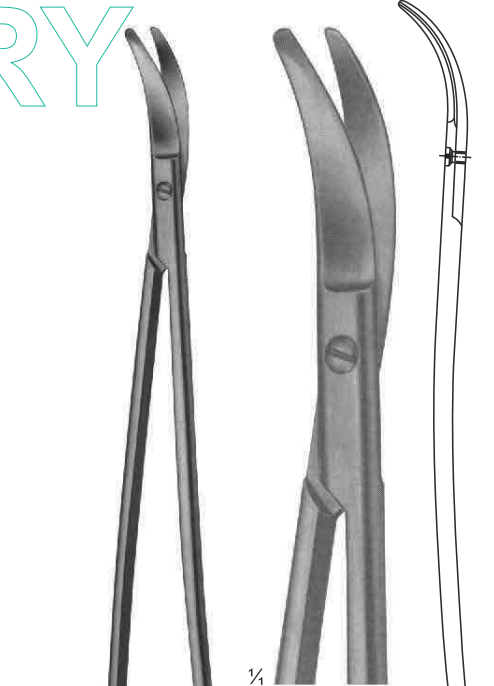

03-296
SATINSKY
Size: 245 mm

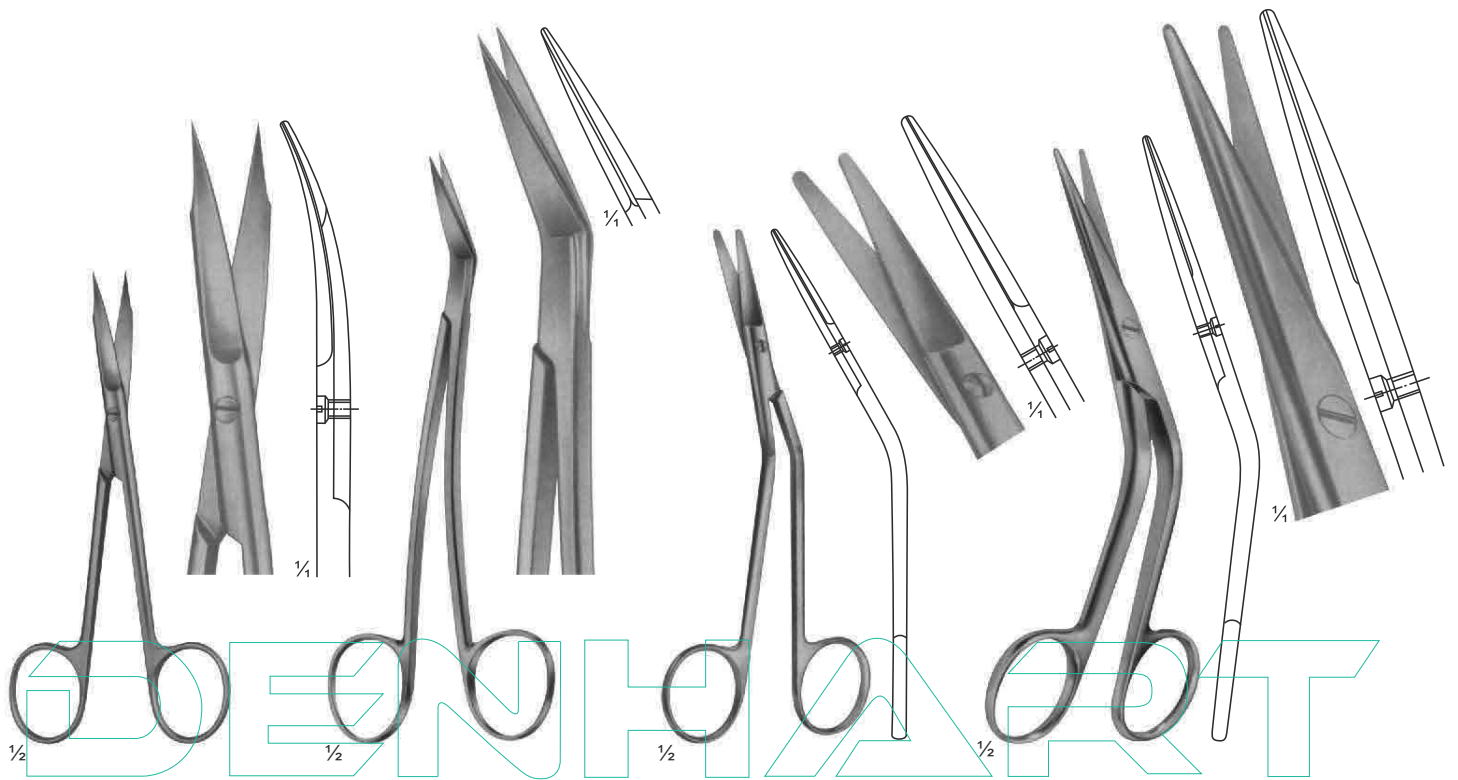

03-297
1 Finaly Toothed Blade
Size: 130 mm

03-298
LOCKLIN
Curved Sideways,
1 Toothed Blade
Size: 155 mm

03-299
FOMON
Blades Serrated
Size: 145 mm

03-300
COTTLE
Size: 165 mm

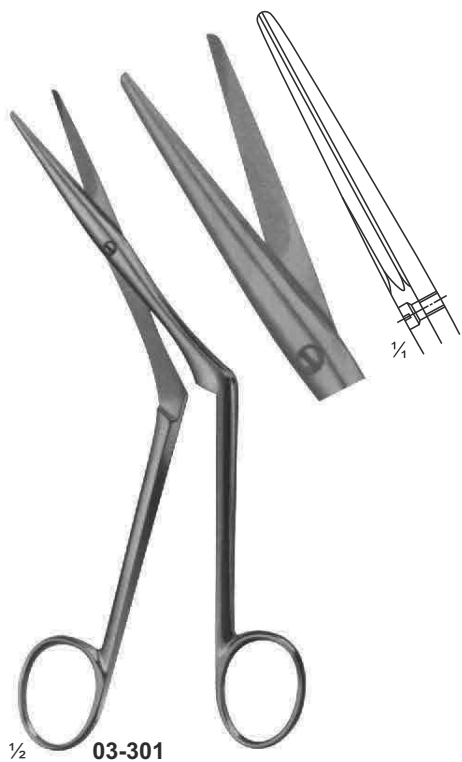

03-301
HEYMANN-KNIGHT
Size: 175 mm

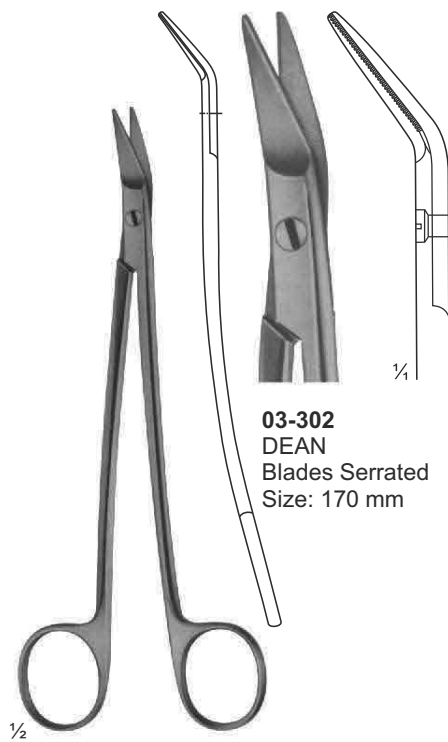

03-302
DEAN
Blades Serrated
Size: 170 mm

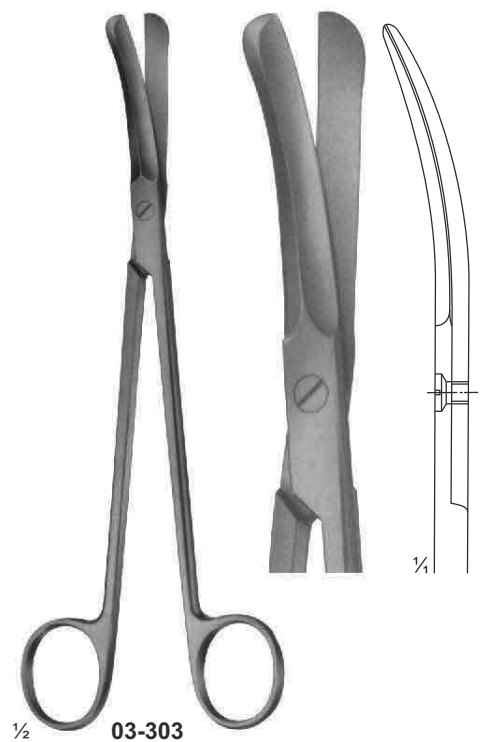

03-303
GOOD
Size: 195 mm

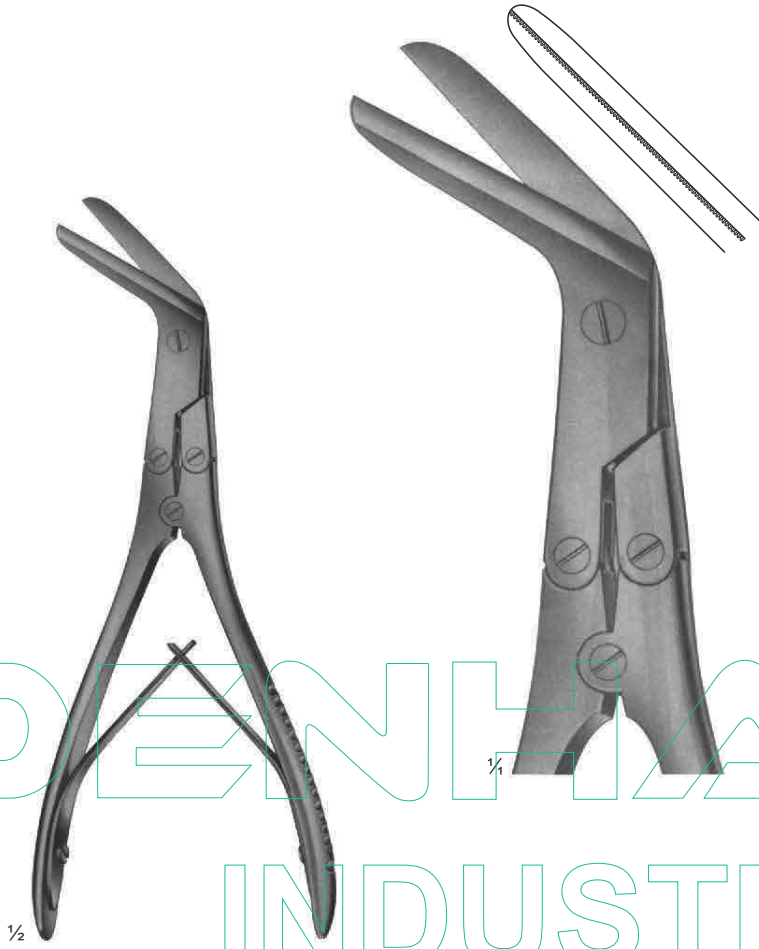

03-304
KILLIAN
Size: 200 mm

DENHART
INDUSTRY



03-305 - 306

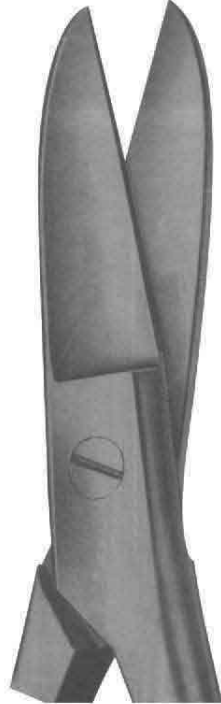

03-305
195 mm

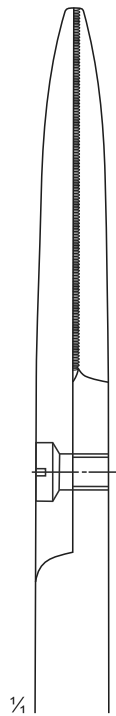

1/4



03-306
225 mm

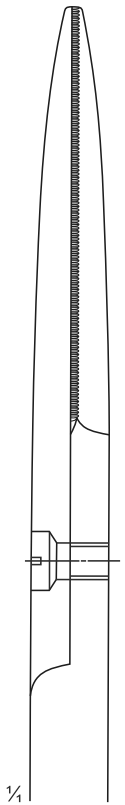

1/4

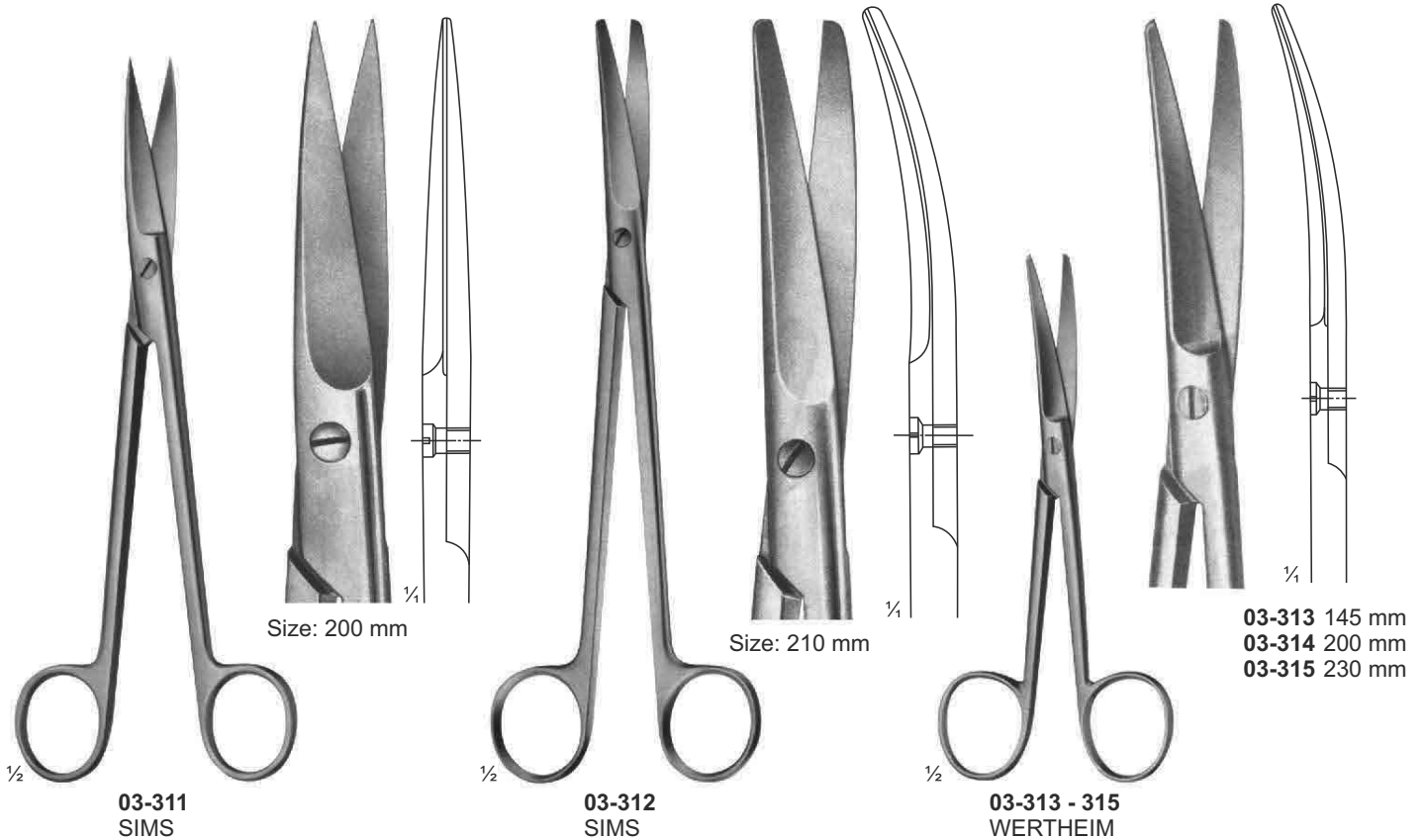
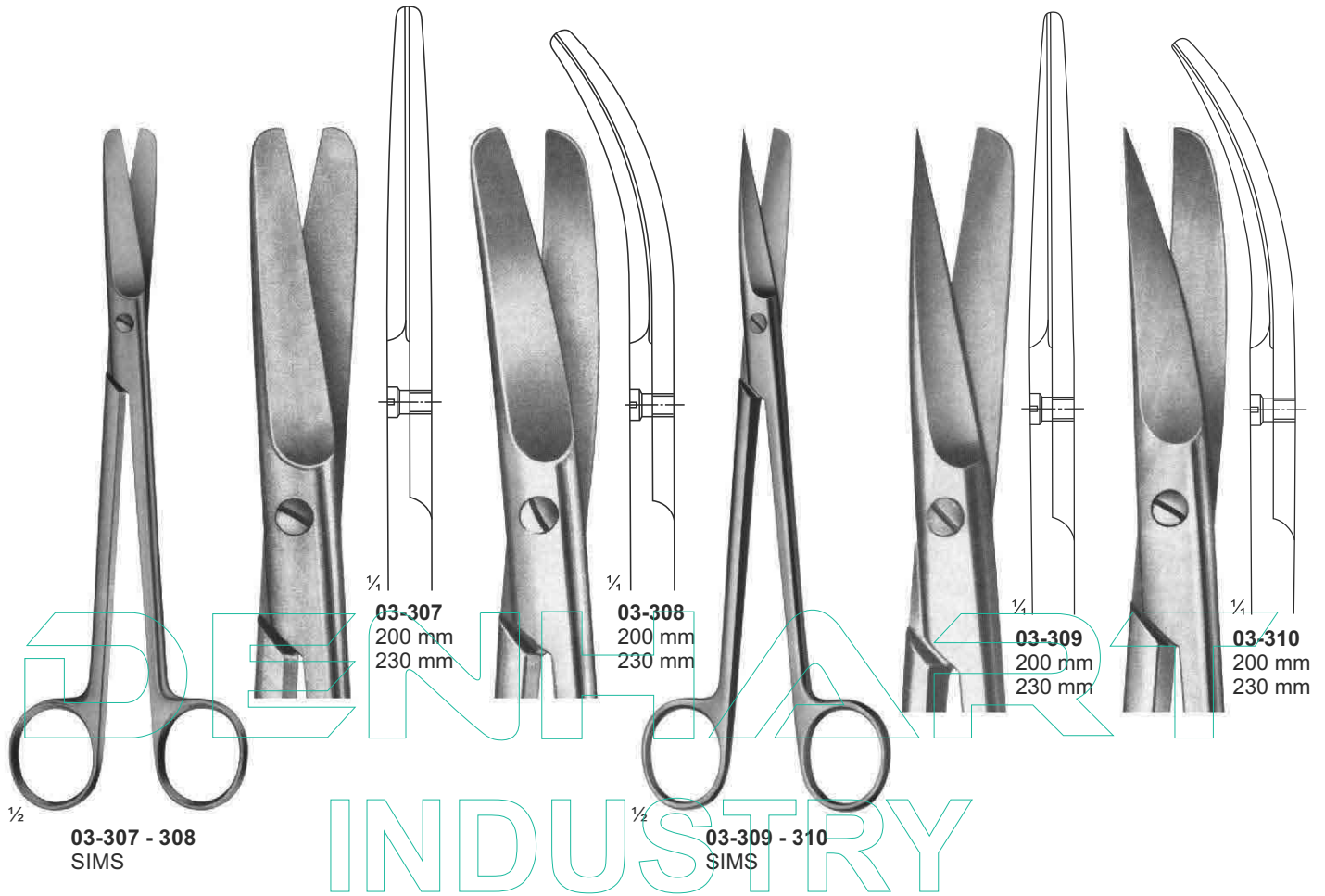



03-316
SIEBOLD
Uterine Scissors
Size: 245 mm

03-317
BOZEMANN
Uterine Scissors
Size: 220 mm

03-318
SIMS-SIEBOLD
Uterine Scissors
Size: 250 mm

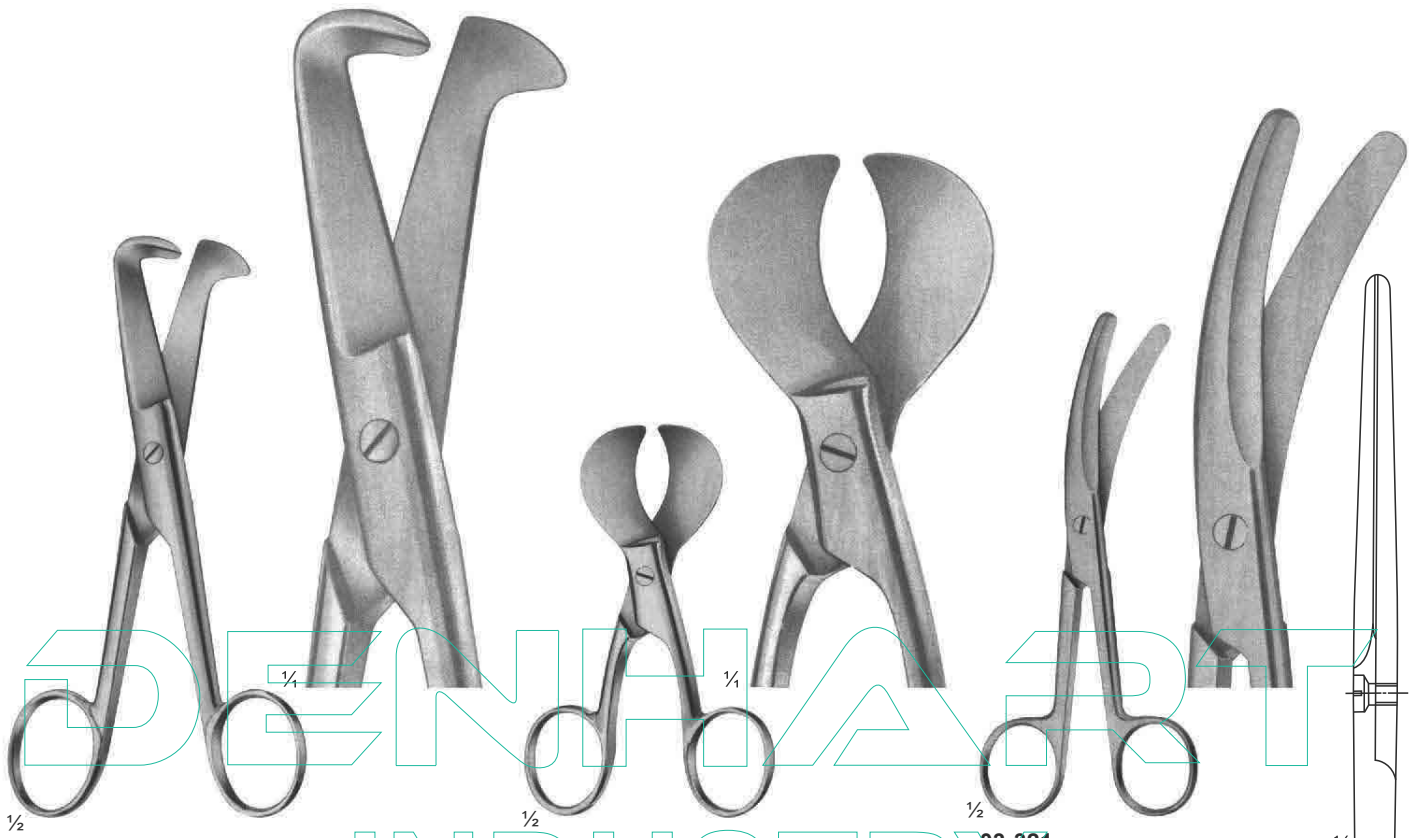

03-319
SCHUMACHER
Umbilical Cord Scissors
Size: 155 mm

03-320
Umbilical Cord Scissors
Size: 105 mm

03-321
Umbilical Cord Scissors

$\frac{1}{4}$
135 mm



03-322 - 323
BRAUN-STADLER
Episiotomy Scissors

03-322
145 mm

03-323
200 mm

03-324
DAMMSCHERE
Episiotomy Scissors
240 mm

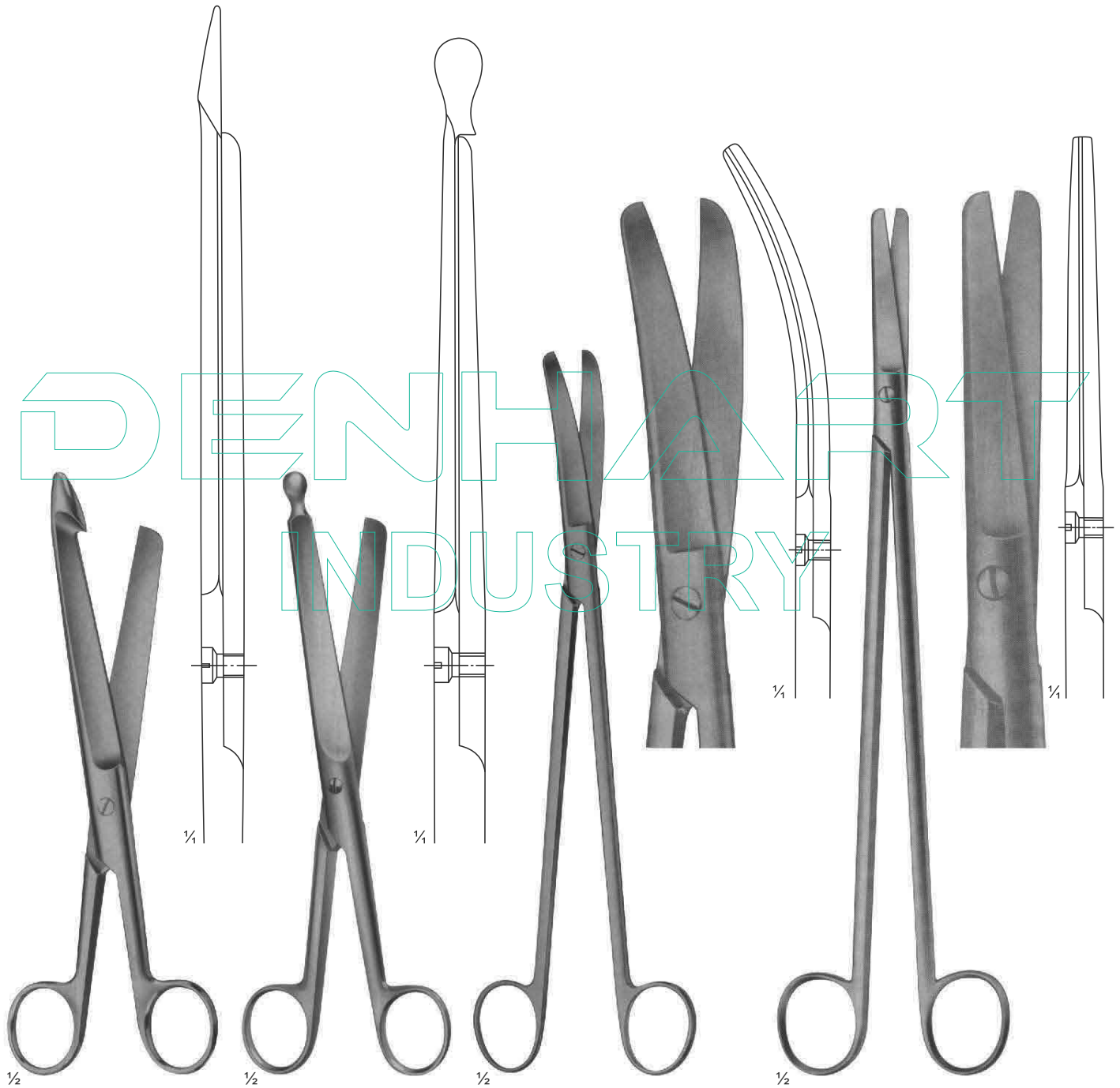

03-325
DAMMSCHERE
Bowel Scissors
Size: 210 mm

03-326
DAMMSCHERE
Bowel Scissors
Size: 210 mm

03-327
LLOYD-DAVIES
(GOLIGHER'S)
Rectal Scissors
Size: 255 mm

03-328
STELZNER
Rectal Scissors
Size: 310 mm

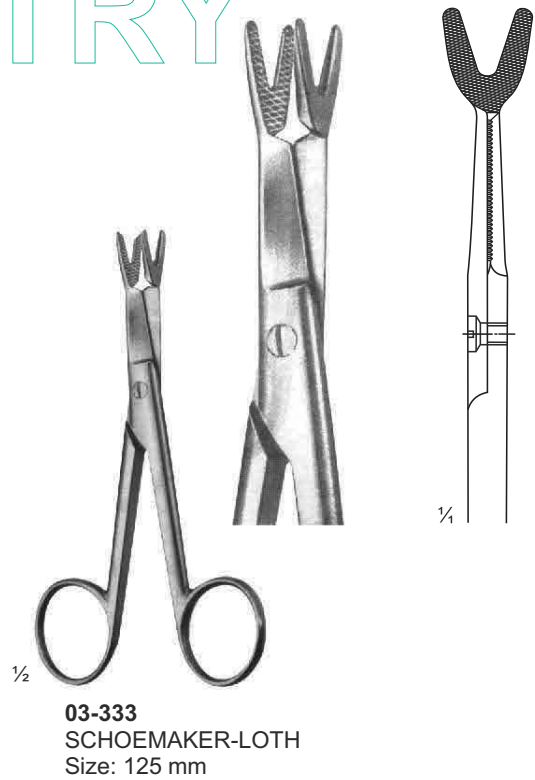
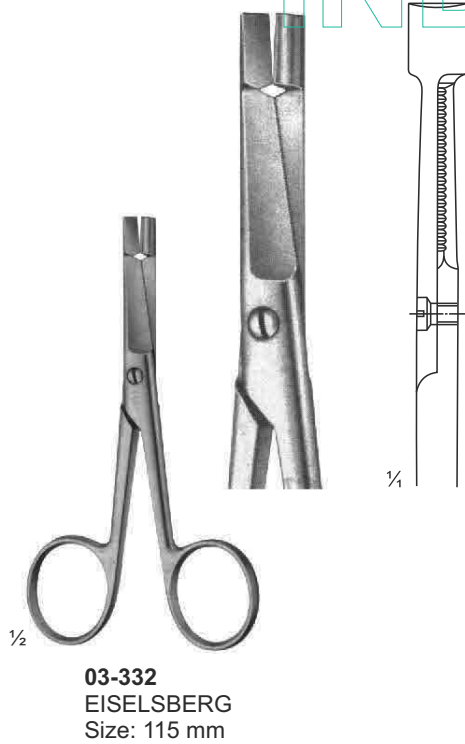
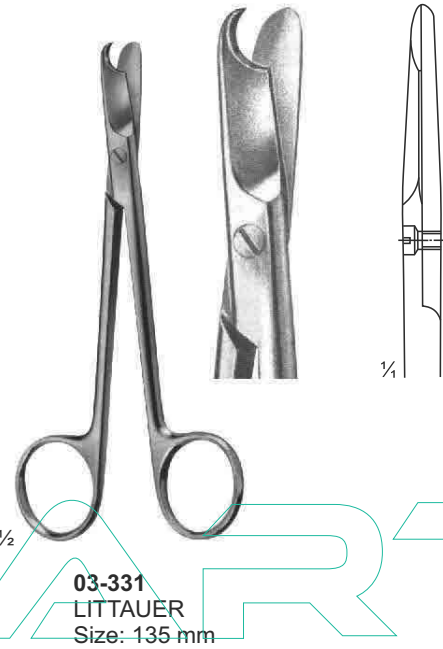
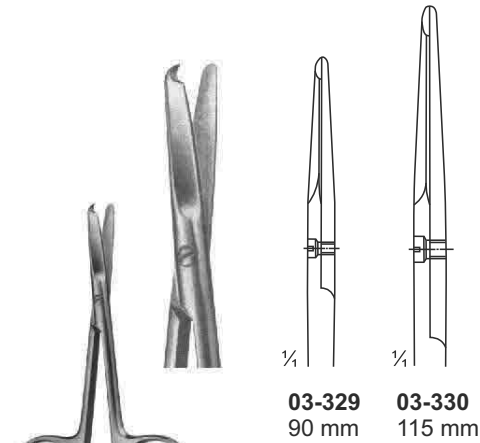

DENHART
INDUSTRY

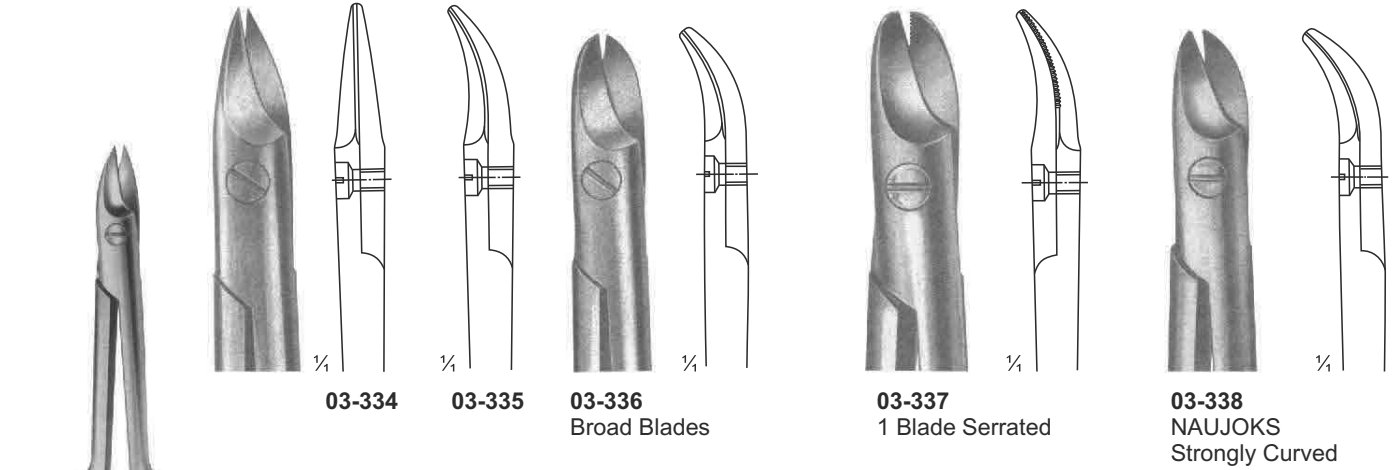

03-334 - 338
BEEBE
Size: 110 mm

DENHART

INDUSTRY

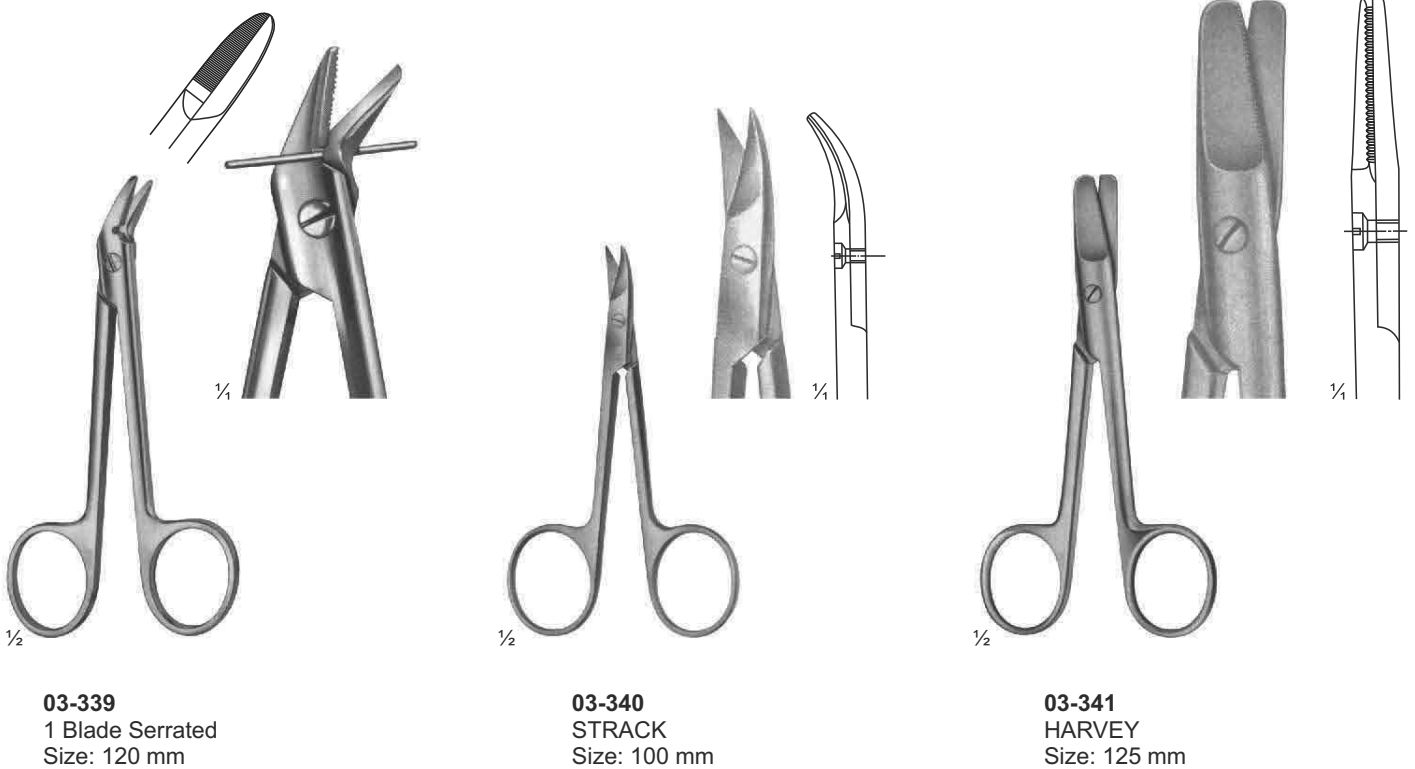

03-339
1 Blade Serrated
Size: 120 mm

03-340
STRACK
Size: 100 mm

03-341
HARVEY
Size: 125 mm

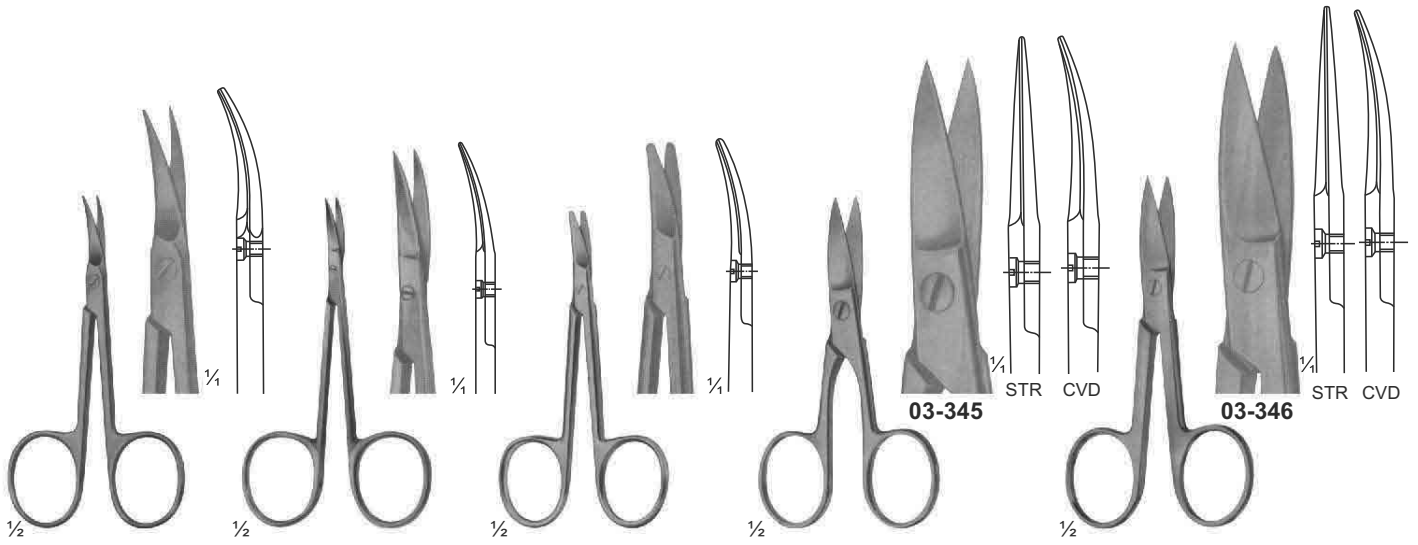

03-342
NAIL SCISSORS
Size: 90 mm

03-343
NAIL SCISSORS
Size: 90 mm

03-344
BABY NAIL SCISSORS
Size: 85 mm

03-345
NAIL SCISSORS
Size: 90 mm

03-346
NAIL SCISSORS
Size: 90 mm

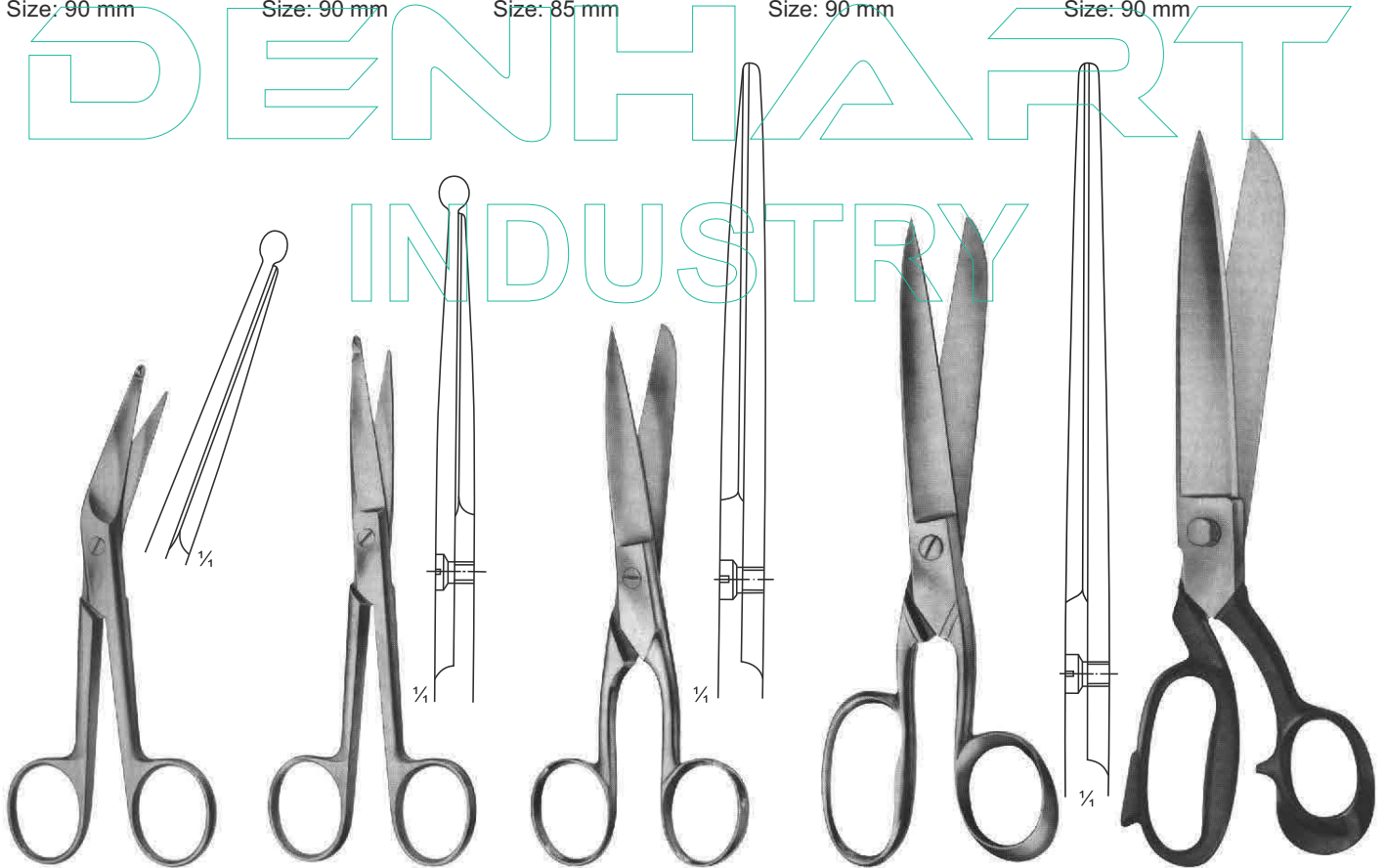

03-347
KNOWLES
Size: 140 mm

03-348
KNOWLES
Size: 145 mm

03-349
Size: 150 mm

03-350
SMITH
Size: 180 mm

03-351
Size: 310 mm



03-352
UNIVERSAL AND BANDAGE SCISSORS
180 mm

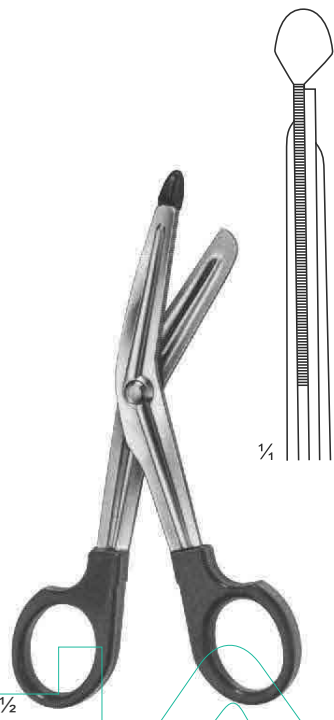

03-353
LISTER
Size: 145 mm

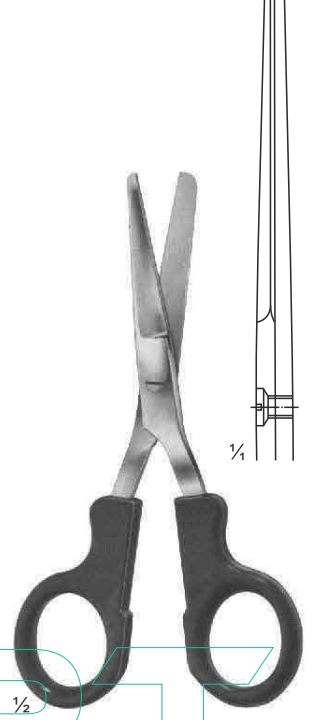

03-354
LISTER
Size: 145 mm

DENHART
INDUSTRY

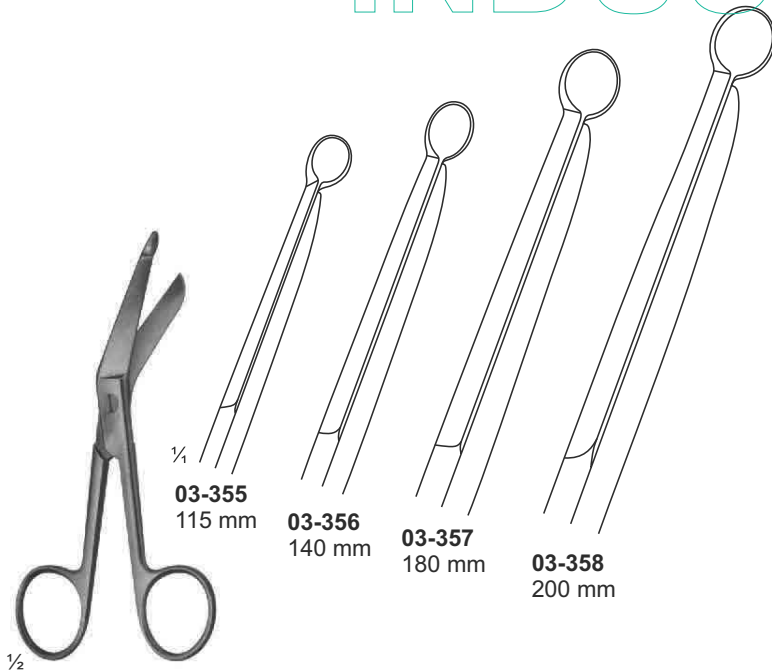

03-355 - 358
LISTER

03-355
115 mm

03-356
140 mm

03-357
180 mm

03-358
200 mm

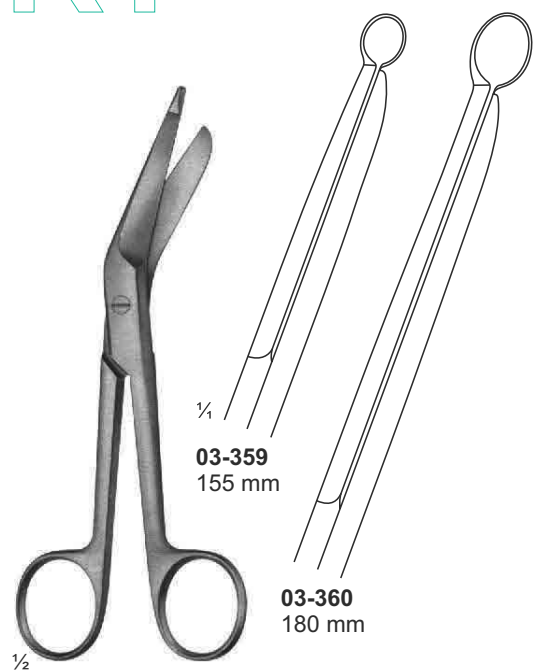

03-359 - 360
LISTER

03-359
155 mm

03-360
180 mm



03-361
CLOTH SCISSORS
205 mm

03-362
BRAUN-STADLER
225 mm

03-363
SEUTIN
230 mm

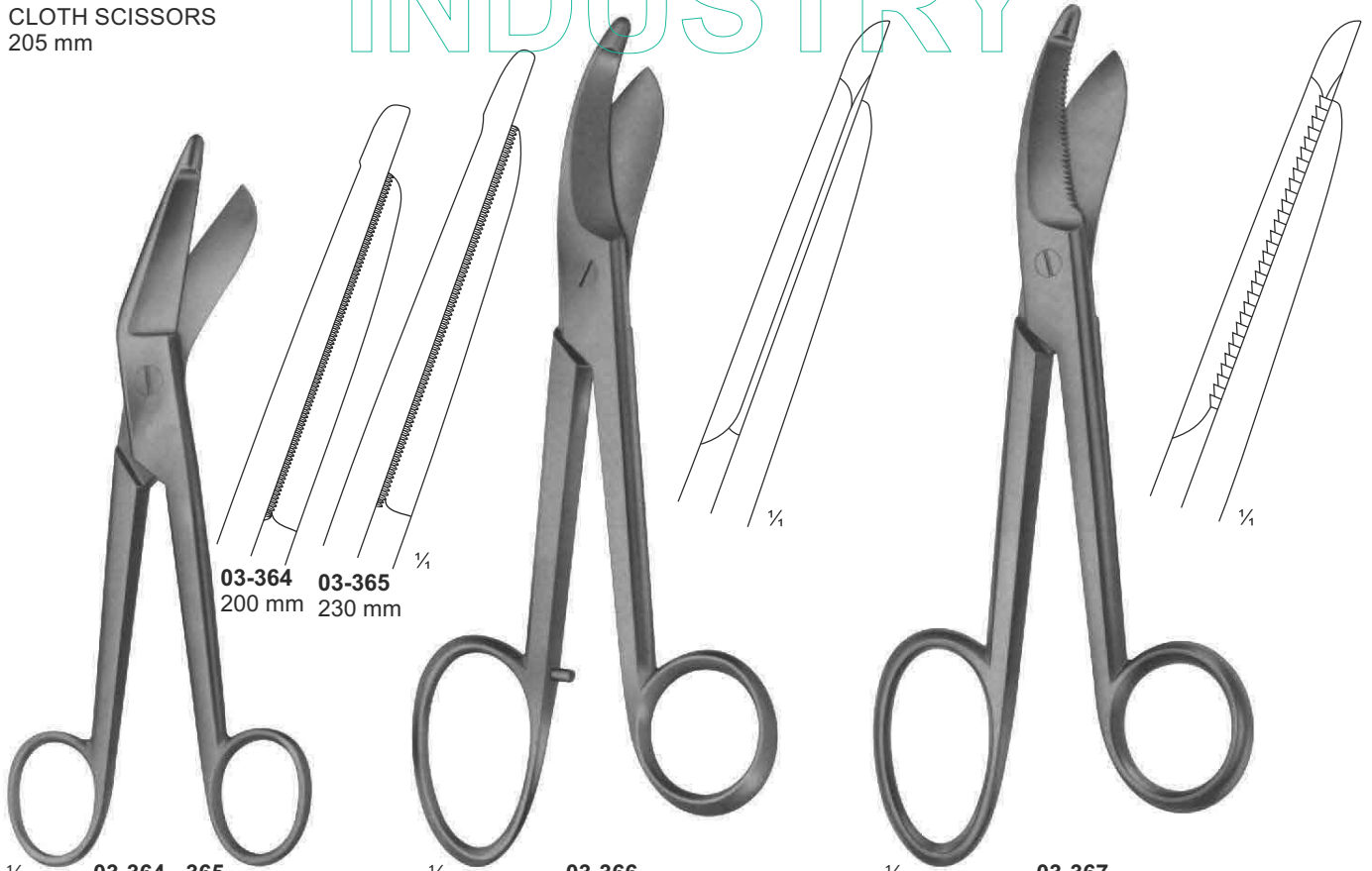

03-364 **03-365**
200 mm 230 mm

03-364 - 365
ESMARCH

03-366
BRUNS
235 mm

03-367
BRUNS
235 mm

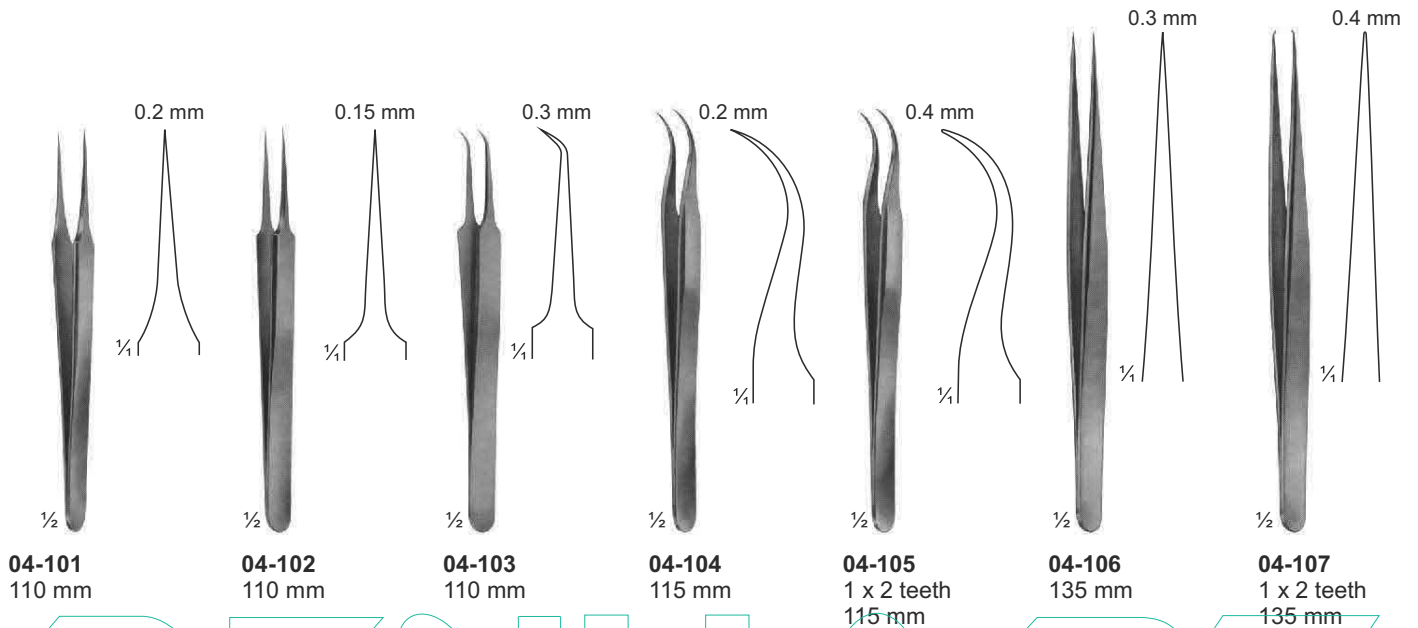

DENHART

INDUSTRY

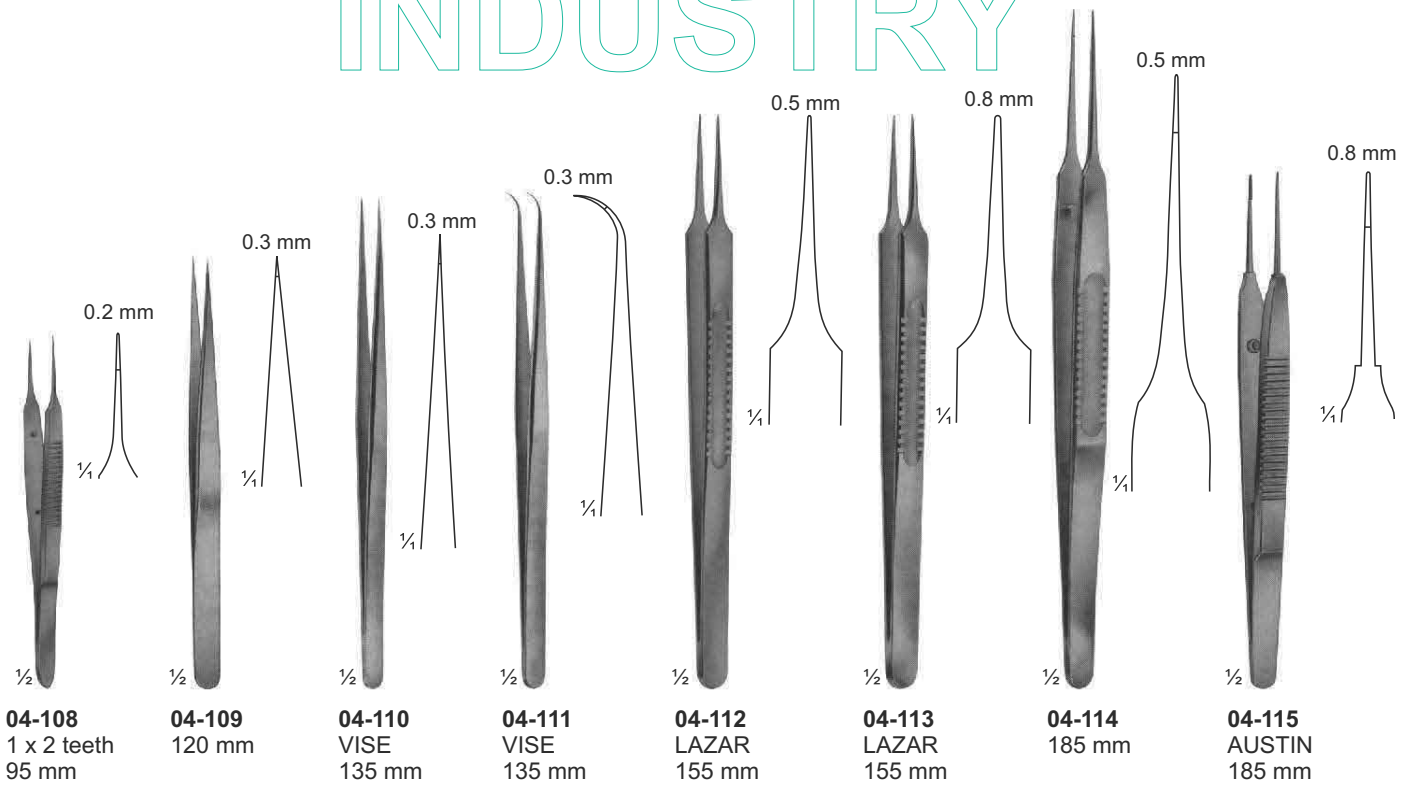

Ligature Forceps, Micro Forceps (Light Patterns)

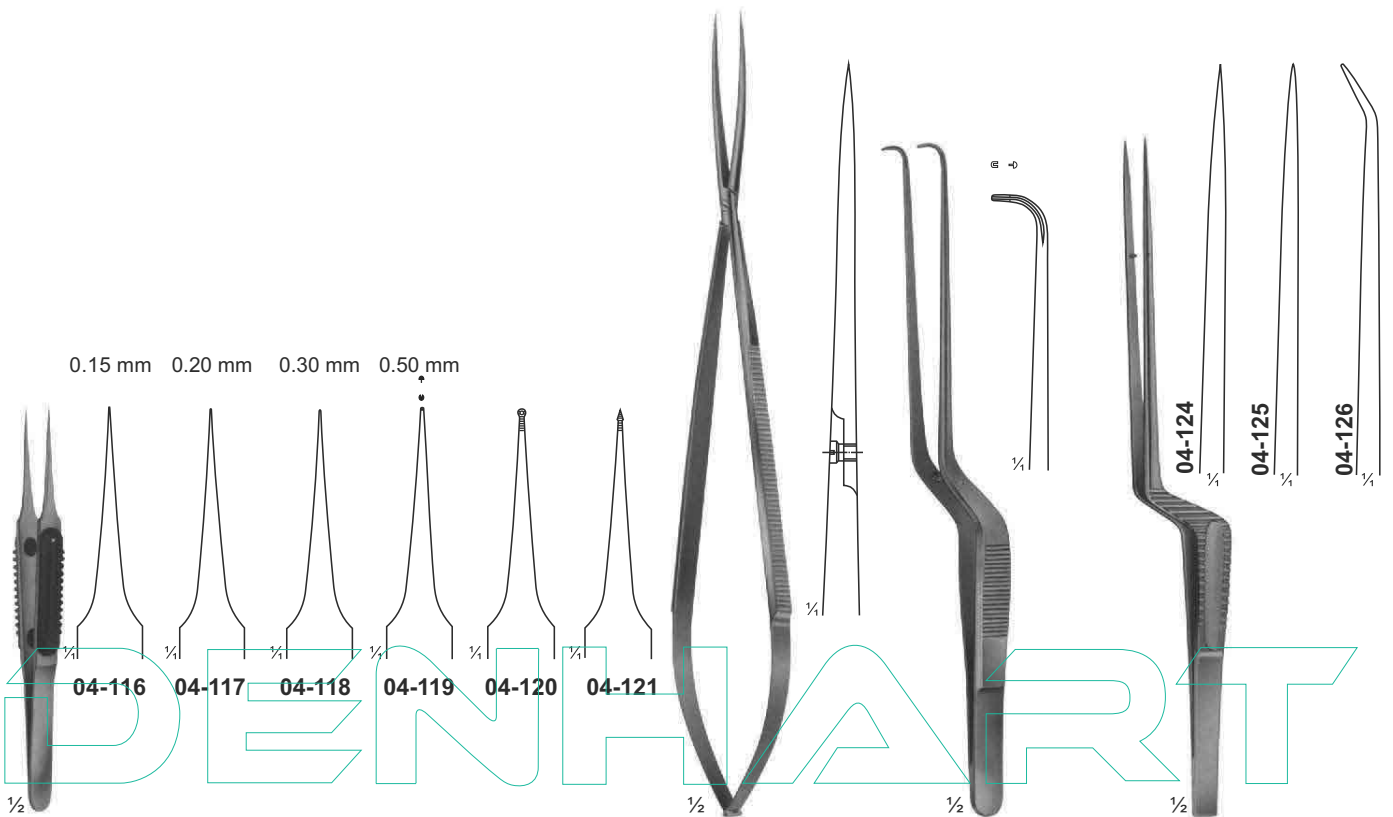

04-116 - 121
MULLER
110 mm

04-122
LIGATURE FORCEPS
220 mm

04-123
YASARGIL
185 mm

04-124 - 126
MICRO FORCEPS
185 mm

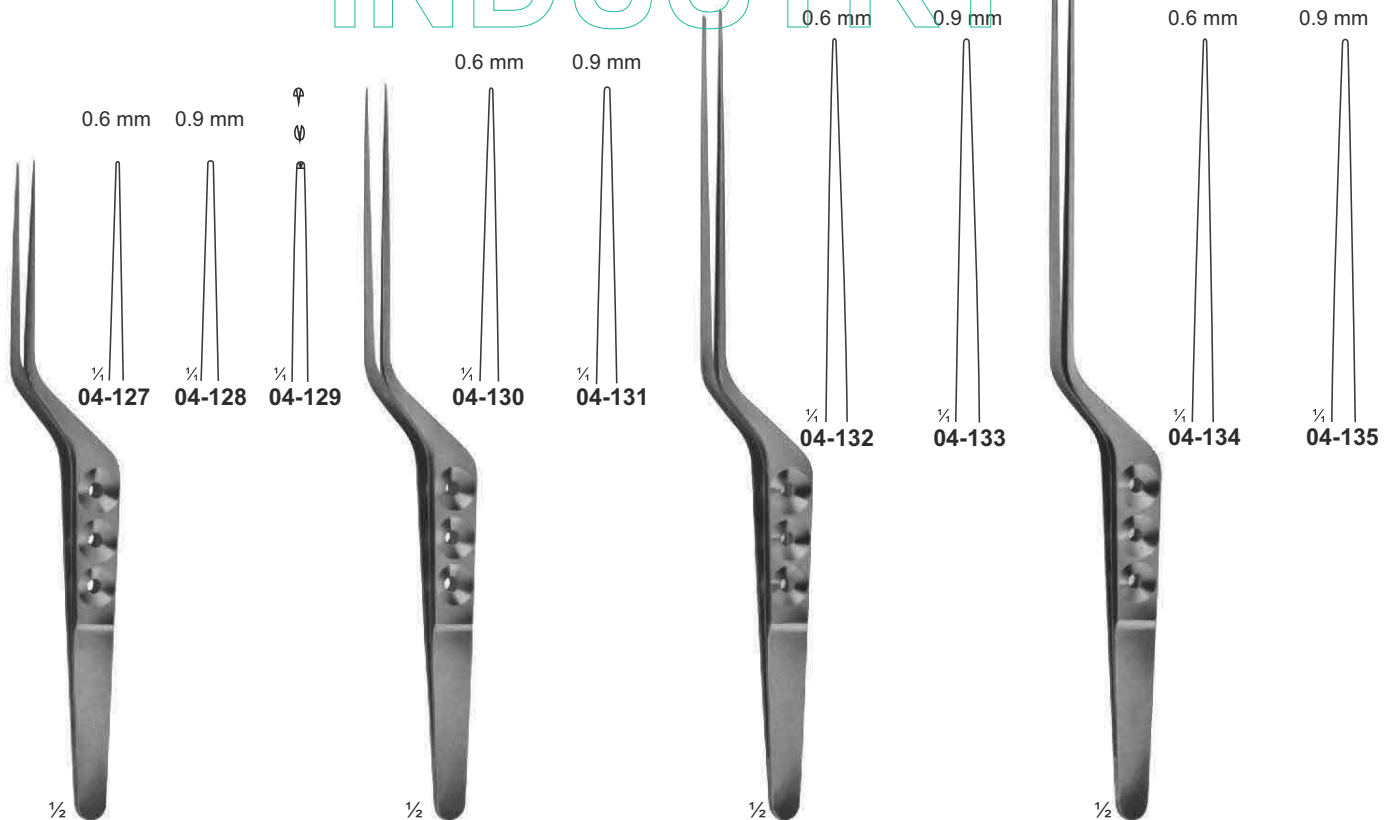

04-127 - 129
YASARGIL
180 mm

04-130 - 131
YASARGIL
200 mm

04-132 - 133
YASARGIL
220 mm

04-134 - 135
YASARGIL
240 mm

Forceps for Grasping Tissue, Tumors



04-136 - 138
YASARGIL-SAMI
Jaws Spoon-Shaped
240 mm



04-139 - 140
YASARGIL
Jaws Spoon-Shaped
220 mm

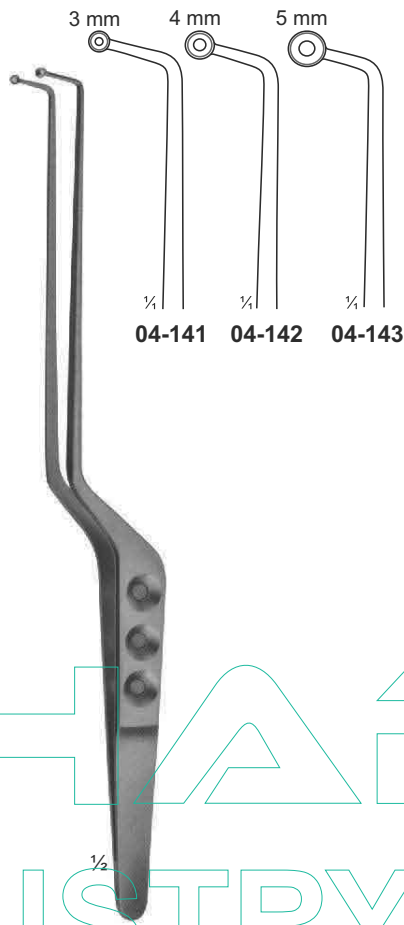

04-141 - 143
SAMII
Jaws Spoon-Shaped
230 mm

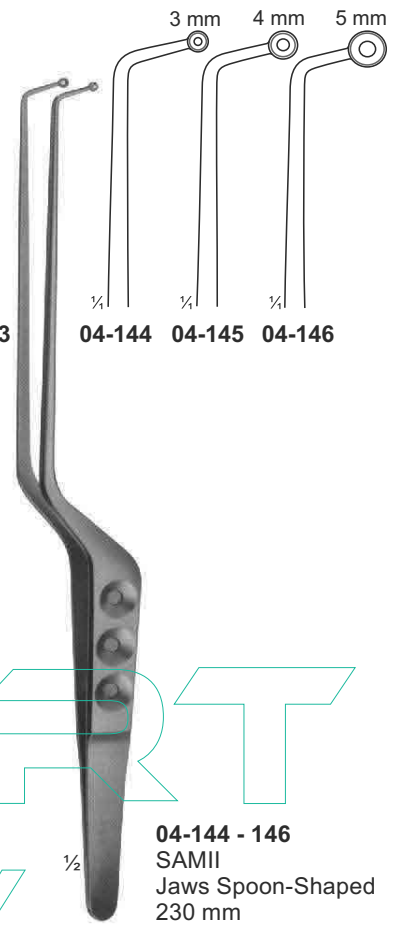

04-144 - 146
SAMII
Jaws Spoon-Shaped
230 mm

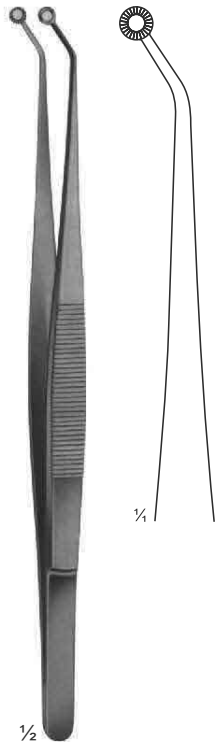

04-147 1/2
HUNT
Tumor-and Vessel Forceps
200 mm



04-148 1/2
HUNT
Tumor-and Vessel Forceps
200 mm

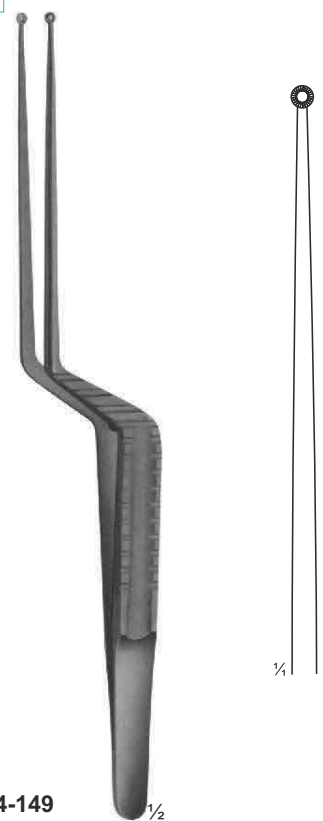

04-149 1/2
YASARGIL
Tumor-and Vessel Forceps
200 mm

Delicate Dissecting, Microscopic, Sterilizing Forceps

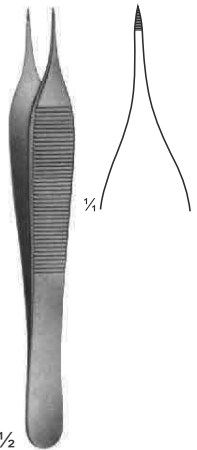

04-150
THORPE
Corneal Forceps
120 mm

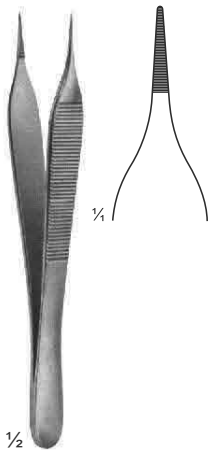

04-151
MICRO-ADSON
120 mm

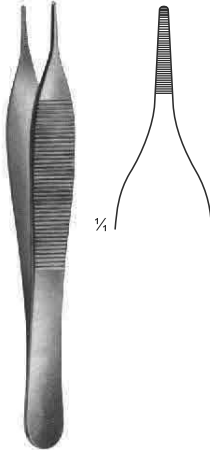

04-152
ADSON
120 mm

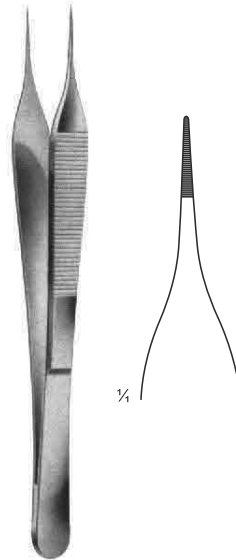

04-153
MICRO-ADSON
150 mm



04-154 - 156
100 mm



04-154



04-155



04-156

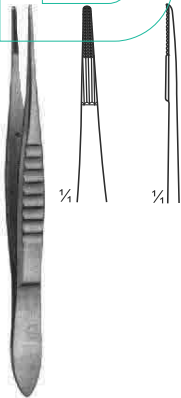

04-157
110 mm

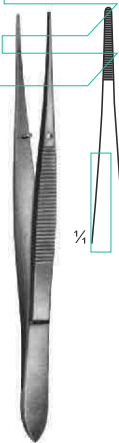

04-158
115 mm



04-159 - 168

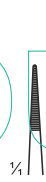

04-159
90 mm



04-160
105 mm



04-161
115 mm



04-162
130 mm



04-163
145 mm



04-164
90 mm



04-165
105 mm



04-166
115 mm



04-167
130 mm



04-168
145 mm



04-169
100 mm

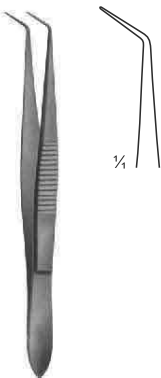

04-170
100 mm



04-171
100 mm

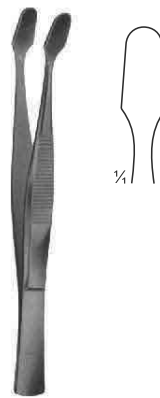

04-172
COVER GLASS FORCEPS
105 mm



04-173
160 mm

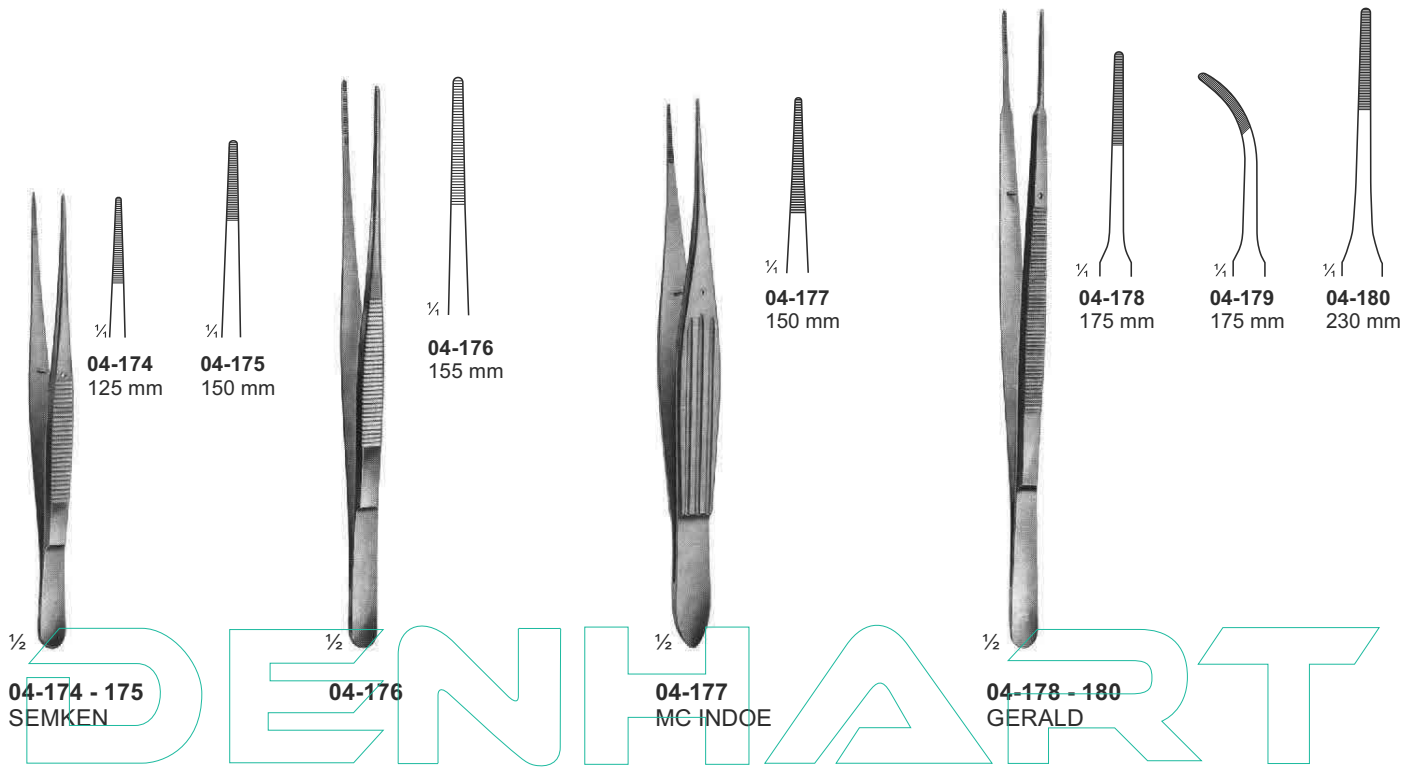

INDUSTRY

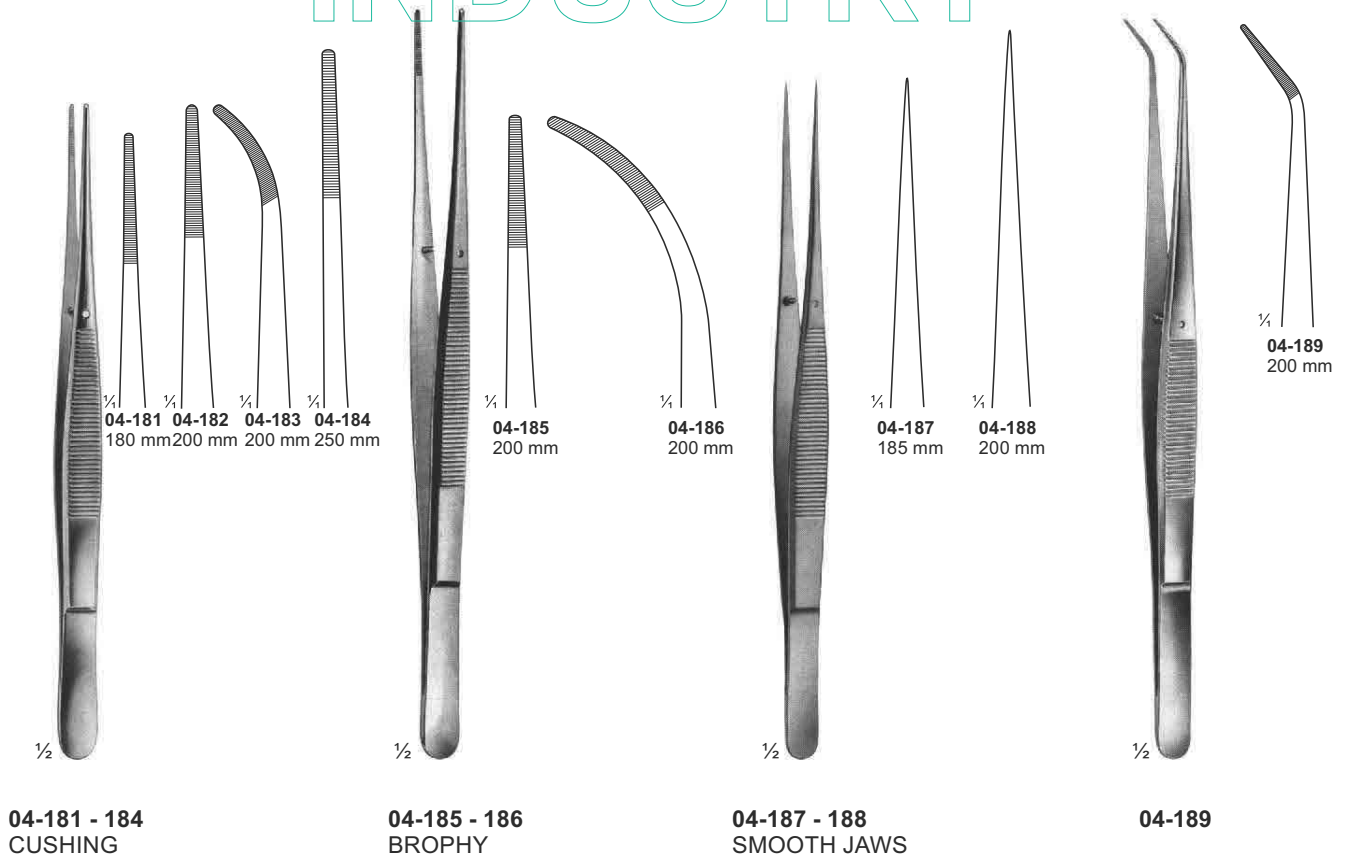

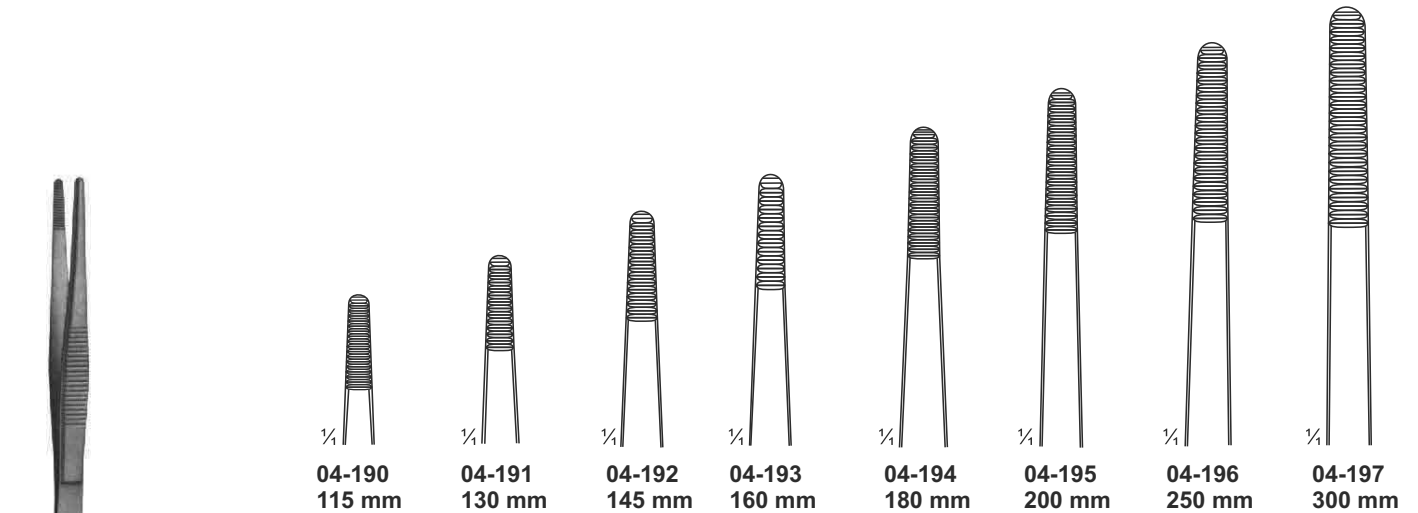

DENHART INDUSTRY

04-190 - 197
STANDARD

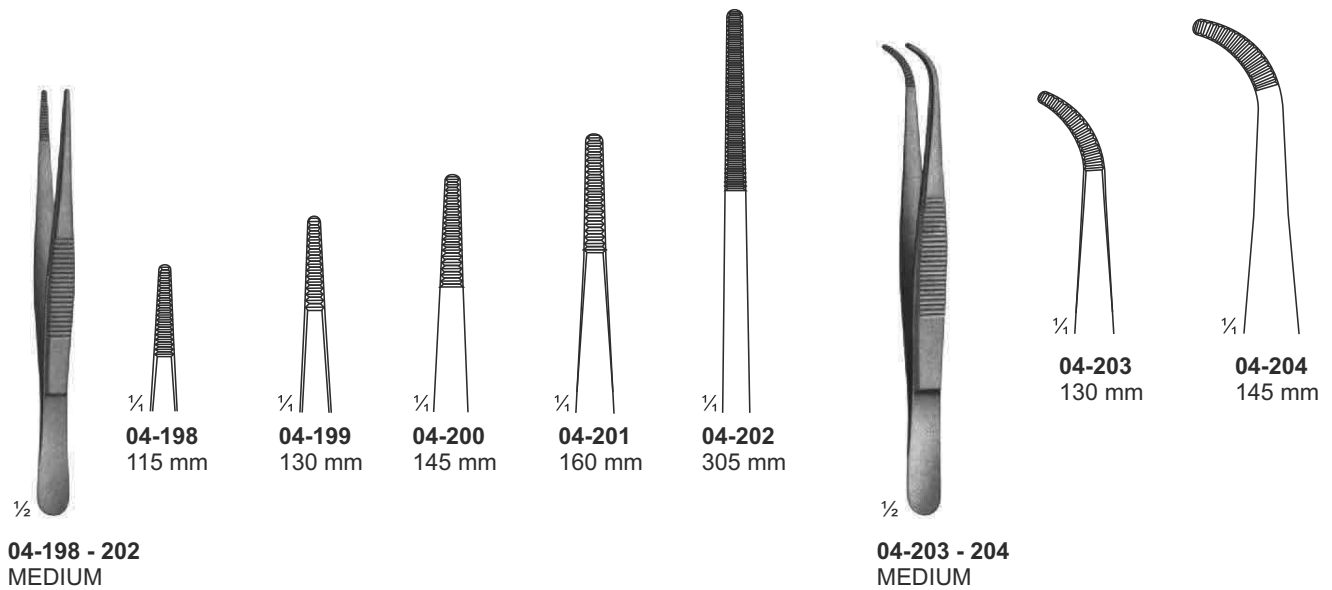

04-198 - 202
MEDIUM

04-203 - 204
MEDIUM

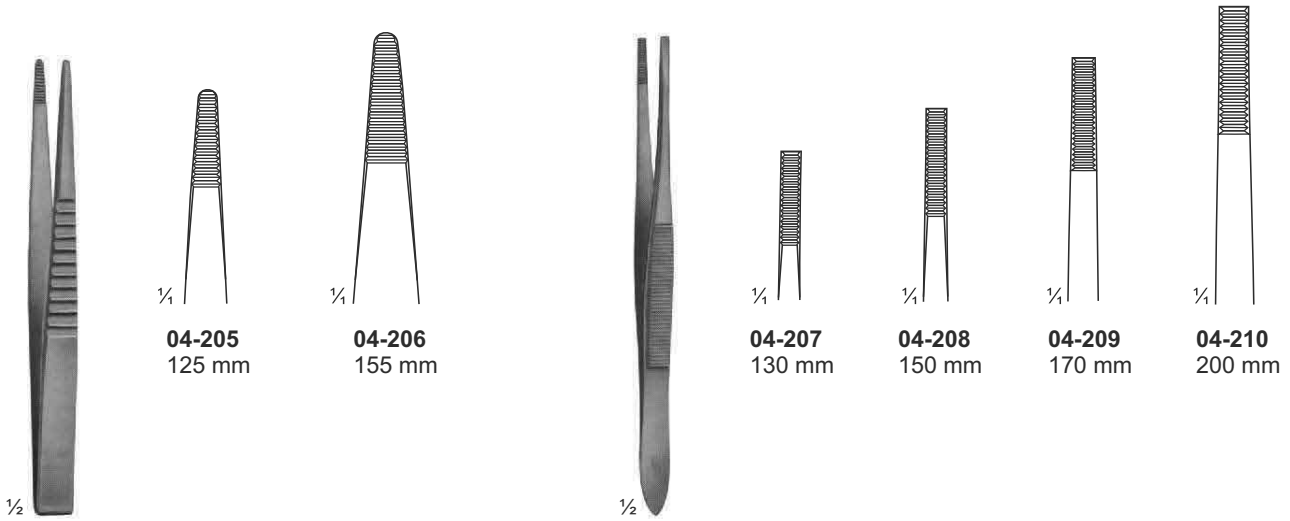

04-205 - 206

04-207 - 210

DENHART

INDUSTRY



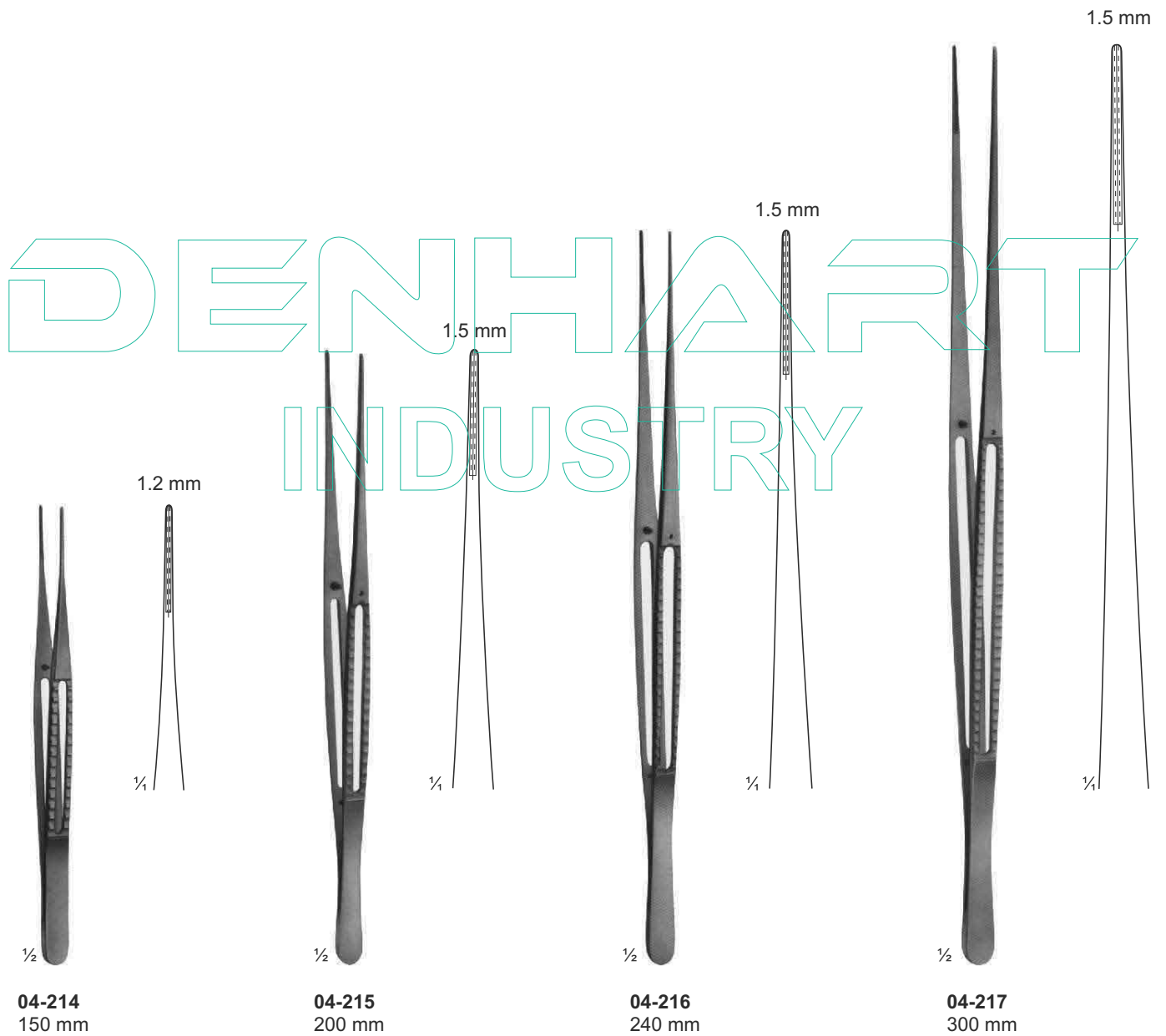

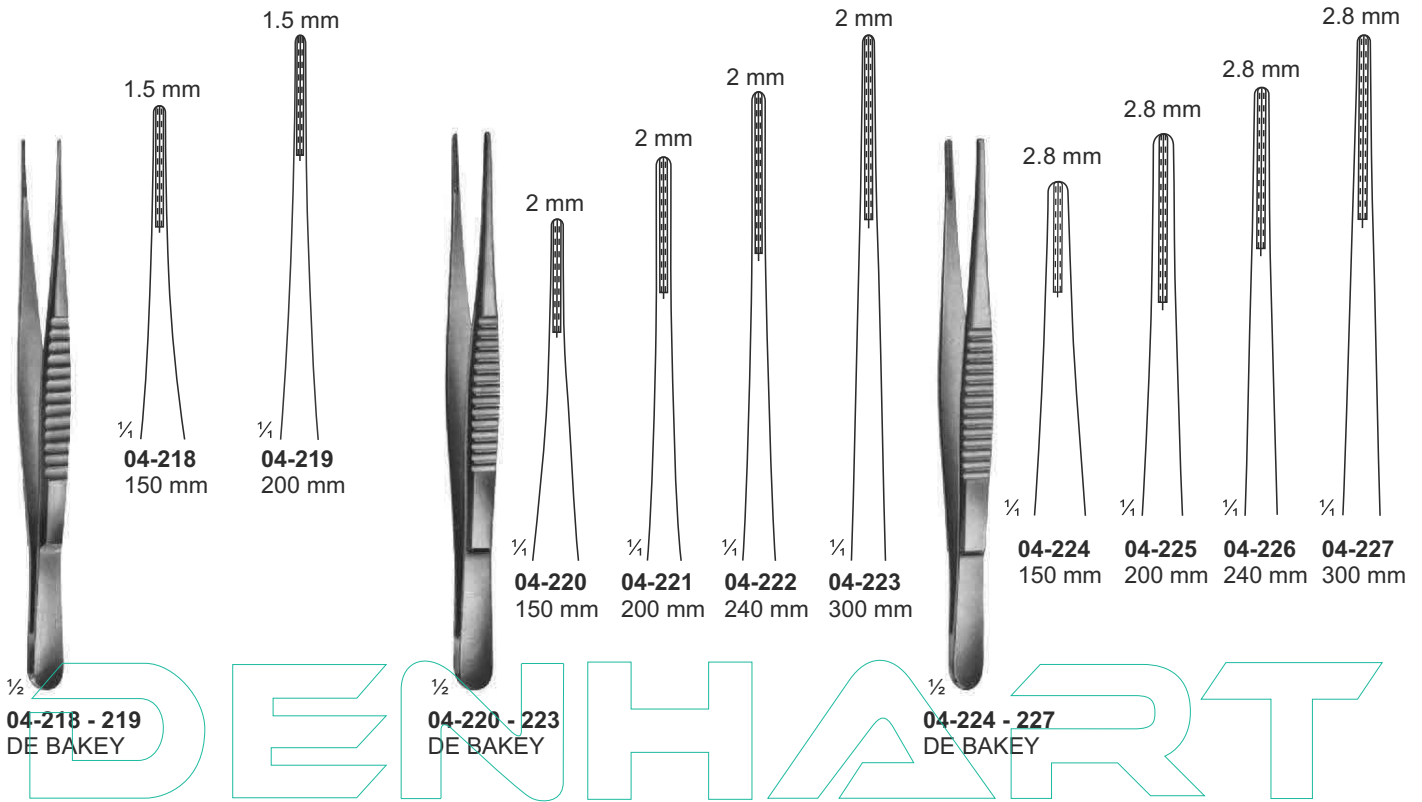

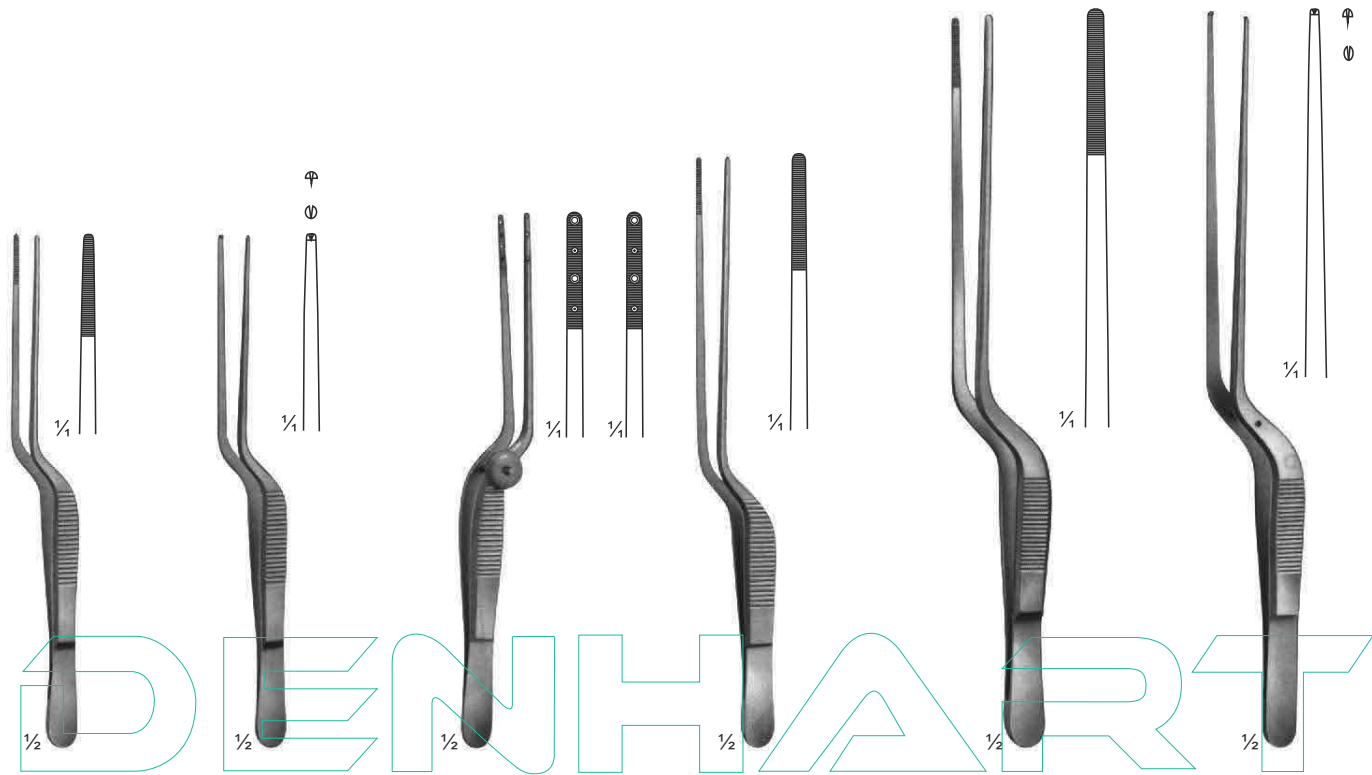

04-233
LUCAE
140 mm

04-234
LUCAE
1x2 teeth
140 mm

04-235
COTTLE
Forceps with
jaws toothed
and serrated
140 mm

04-236
JANSEN
160 mm

04-237
GRUENWALD
200 mm

04-238
1x2 teeth
200 mm

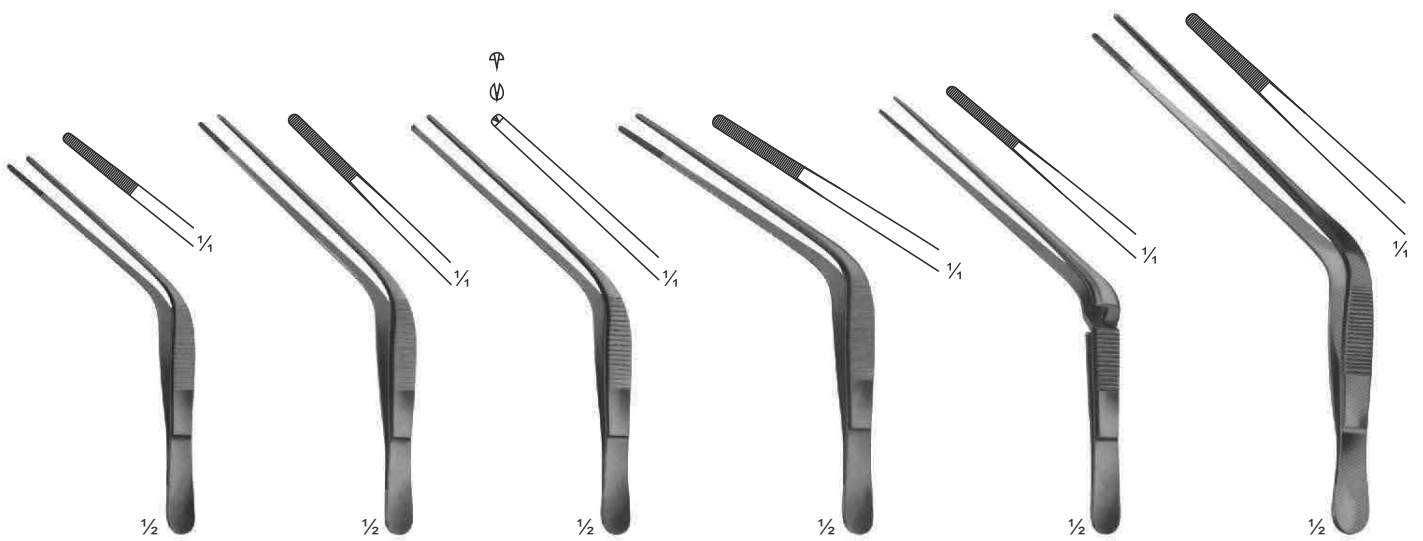

04-239
TROELTSCH
100 mm

04-240
TROELTSCH
115 mm

04-241
TROELTSCH
1X2 teeth
115 mm

04-242
WILDE
115 mm

04-243
TROELTSCH
Cross action
120 mm

04-244
TROELTSCH
140 mm

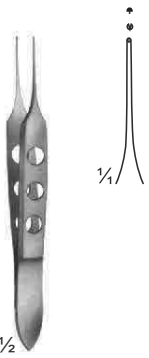

04-245
BISHOP-HARMON
85 mm

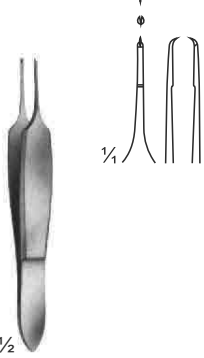

04-246
ST.MARTIN
80 mm

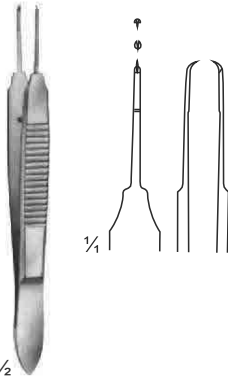

04-247
CASTROVIEJO
teeth 0.9 mm
100 mm

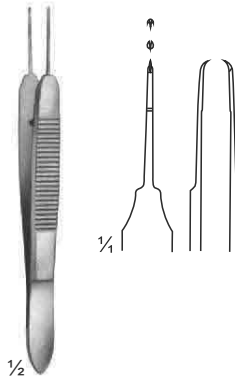

04-248
CASTROVIEJO
teeth 0.5 mm
100 mm

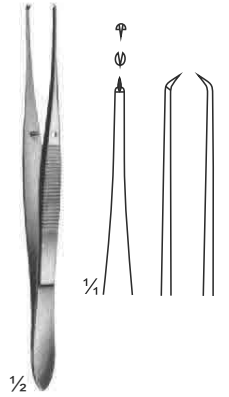

04-249
ELSCHING
110 mm

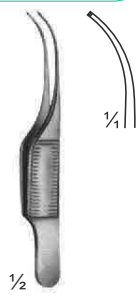
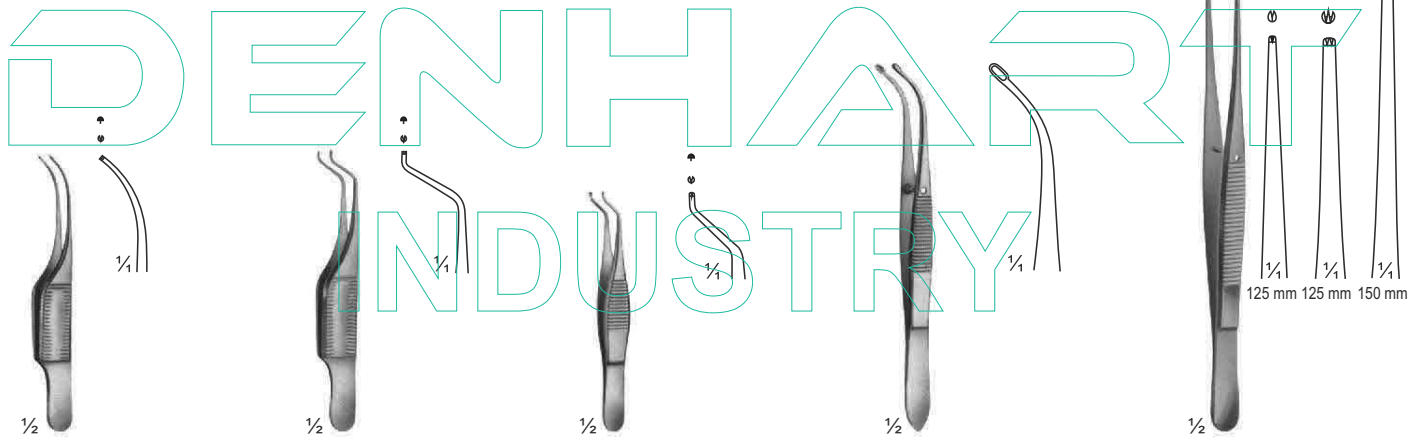

04-250
GILL
75 mm

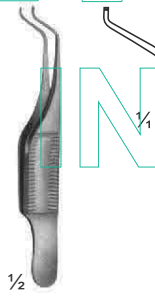

04-251
GILL - HESS
75 mm

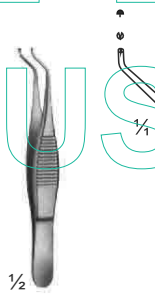

04-252
HESS
70 mm

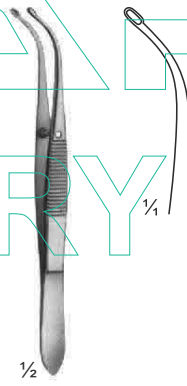

04-253
ARRUGA
100 mm

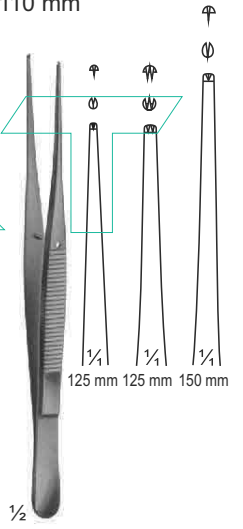

04-254
SEMKEN
125 mm 125 mm 150 mm

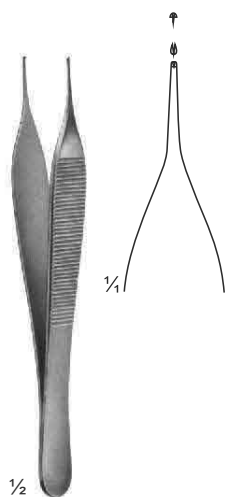

04-255
MICRO-ADSON
120 mm

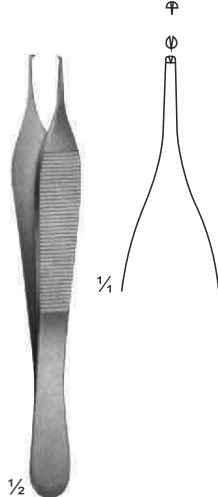

04-256
ADSON
120 mm

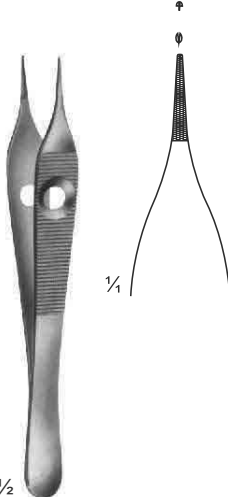

04-257
ADSON
120 mm



04-258
ADSON
120 mm

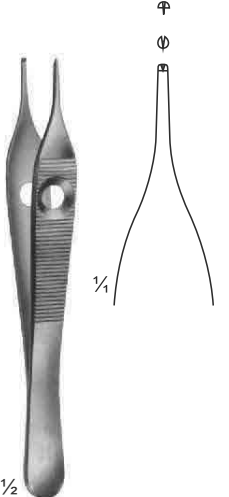

04-259
ADSON
150 mm

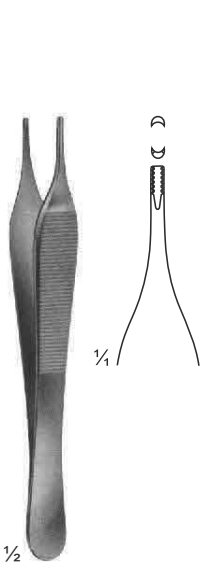

04-260
ADSON - BROWN
Non-traumatic
120 mm

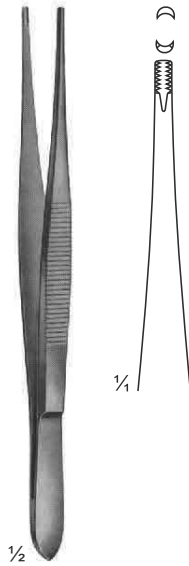

04-261
BROWN
120 mm

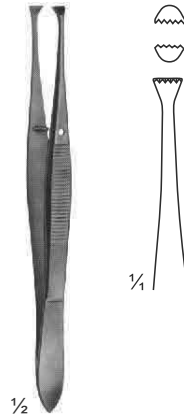

04-262
GRAEFE
110 mm

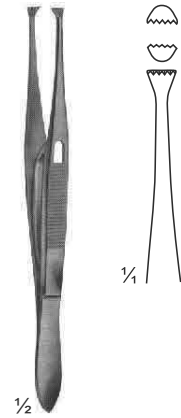

04-263
GRAEFE
With Catch
110 mm

INDUSTRY

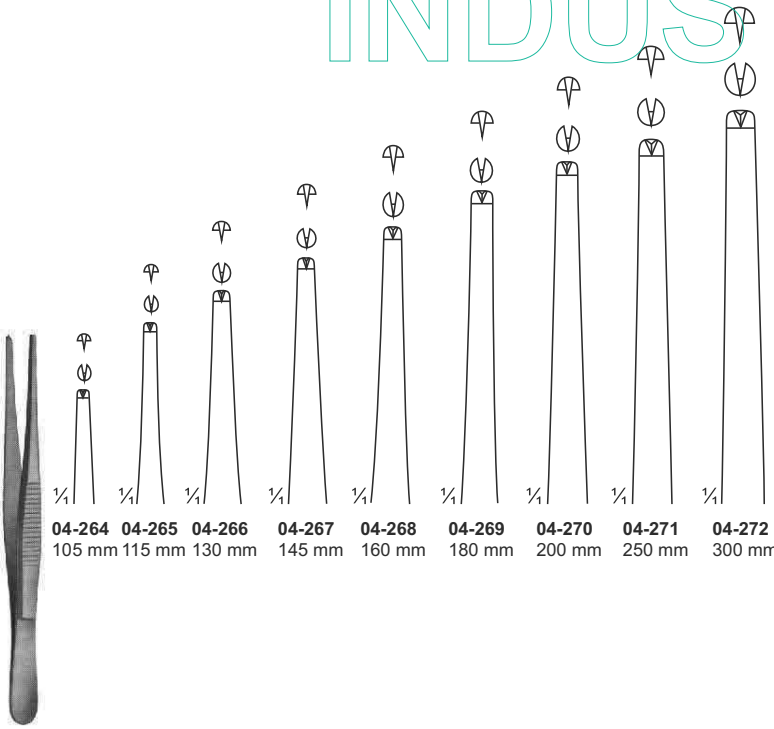

04-264 - 272
STANDARD

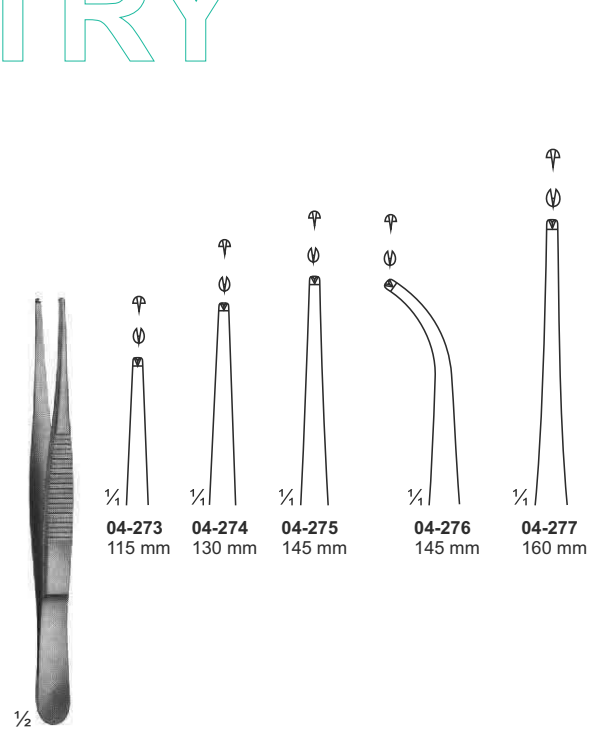

04-273 - 277
GRAEFE
110 mm

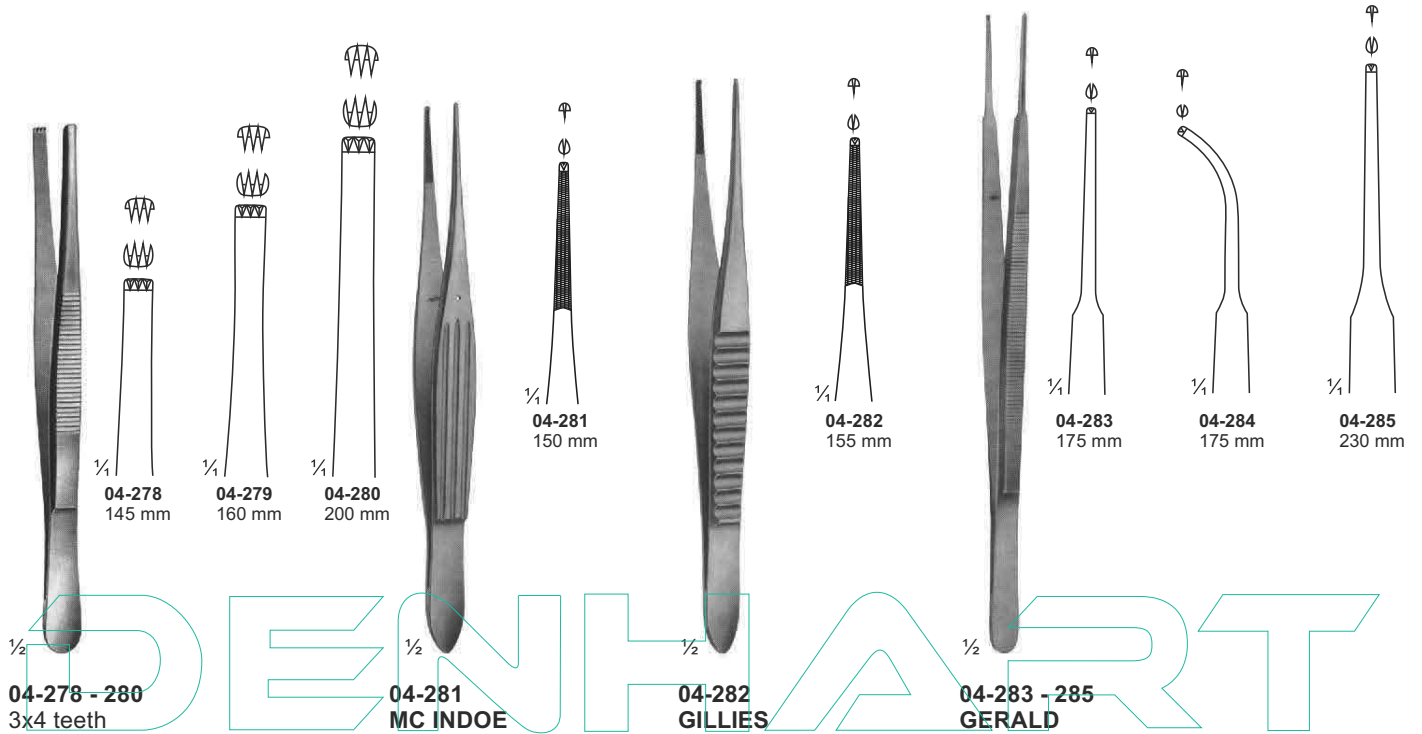

INDUSTRY



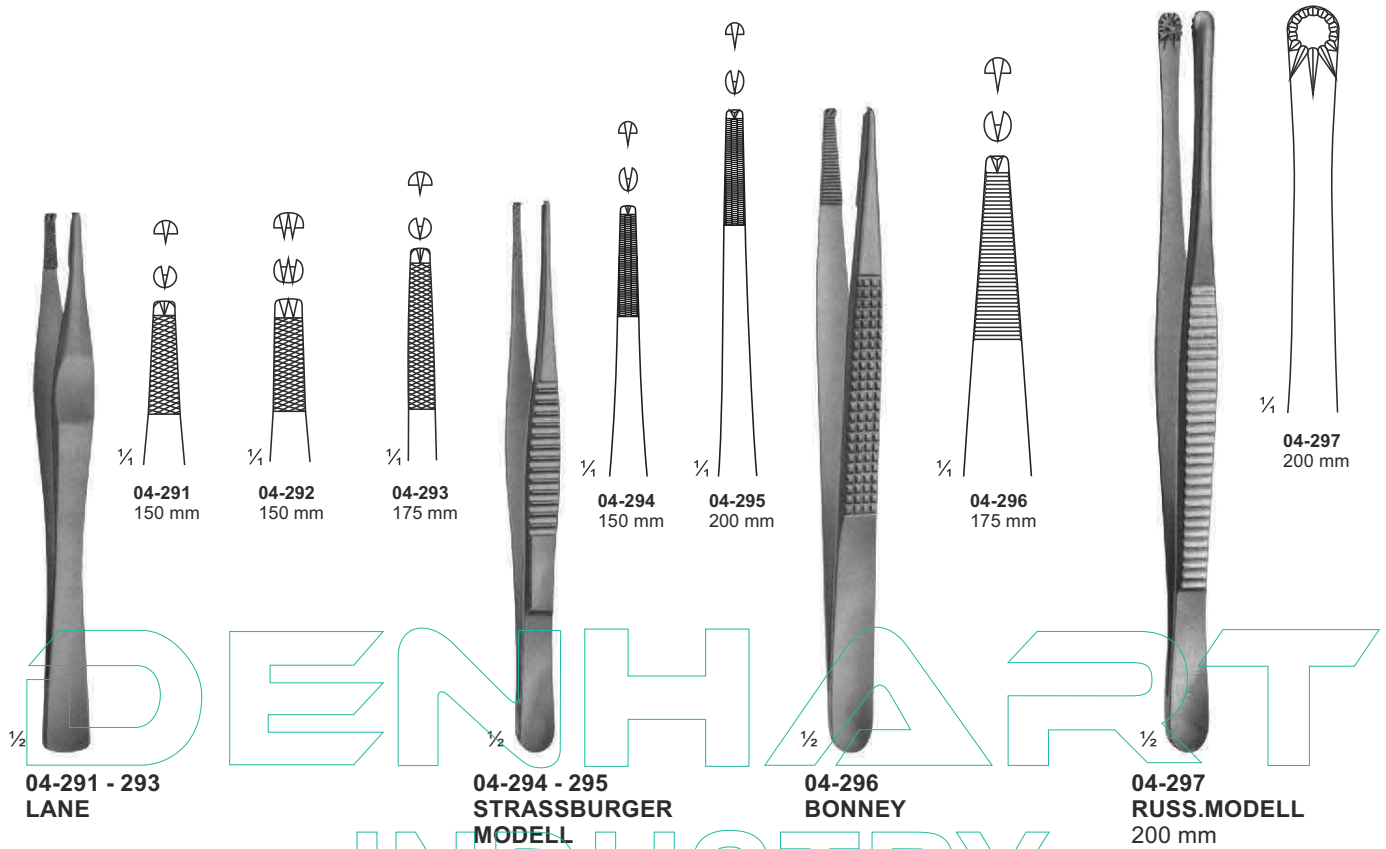

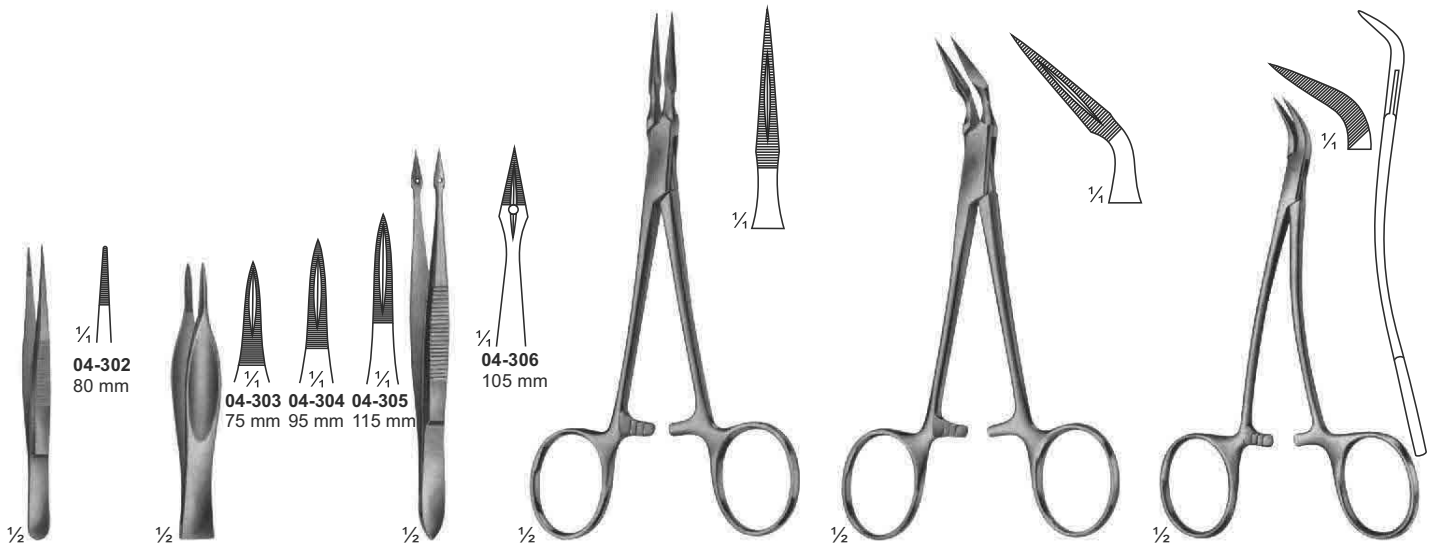

04-302

04-303 - 305
FEILCHENFELD

04-306
HUNTER

04-307
STIEGLITZ
140 mm

04-308
STIEGLITZ
140 mm

04-309
PEET
120 mm

DENHART

INDUSTRY

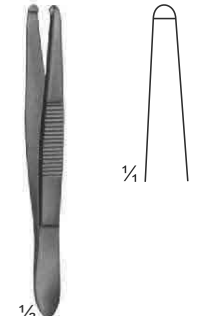

04-310
BEER
85 mm

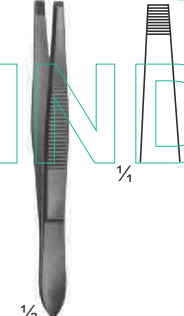

04-311
85 mm

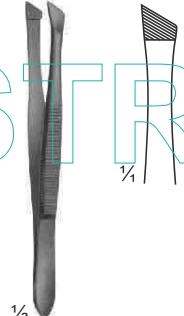

04-312
85 mm

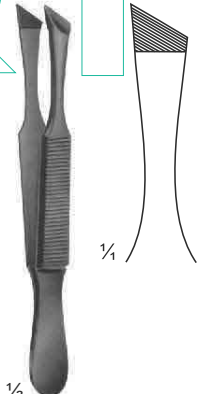

04-313
105 mm

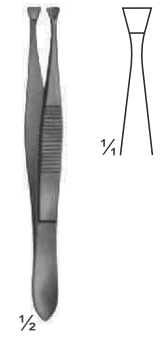

04-314
105 mm

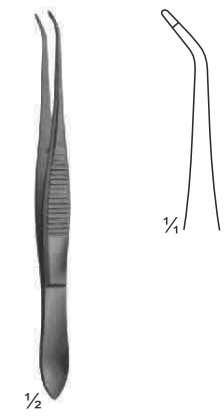

04-315
SAUPE
105 mm

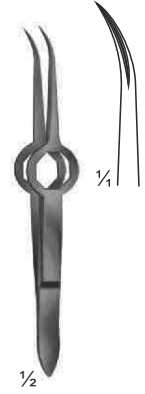

04-316
SCHAAF
95 mm

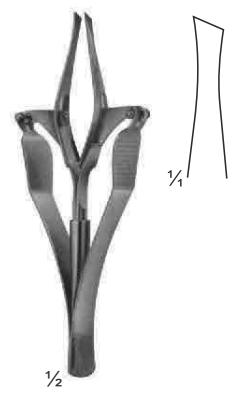

04-317
105 mm

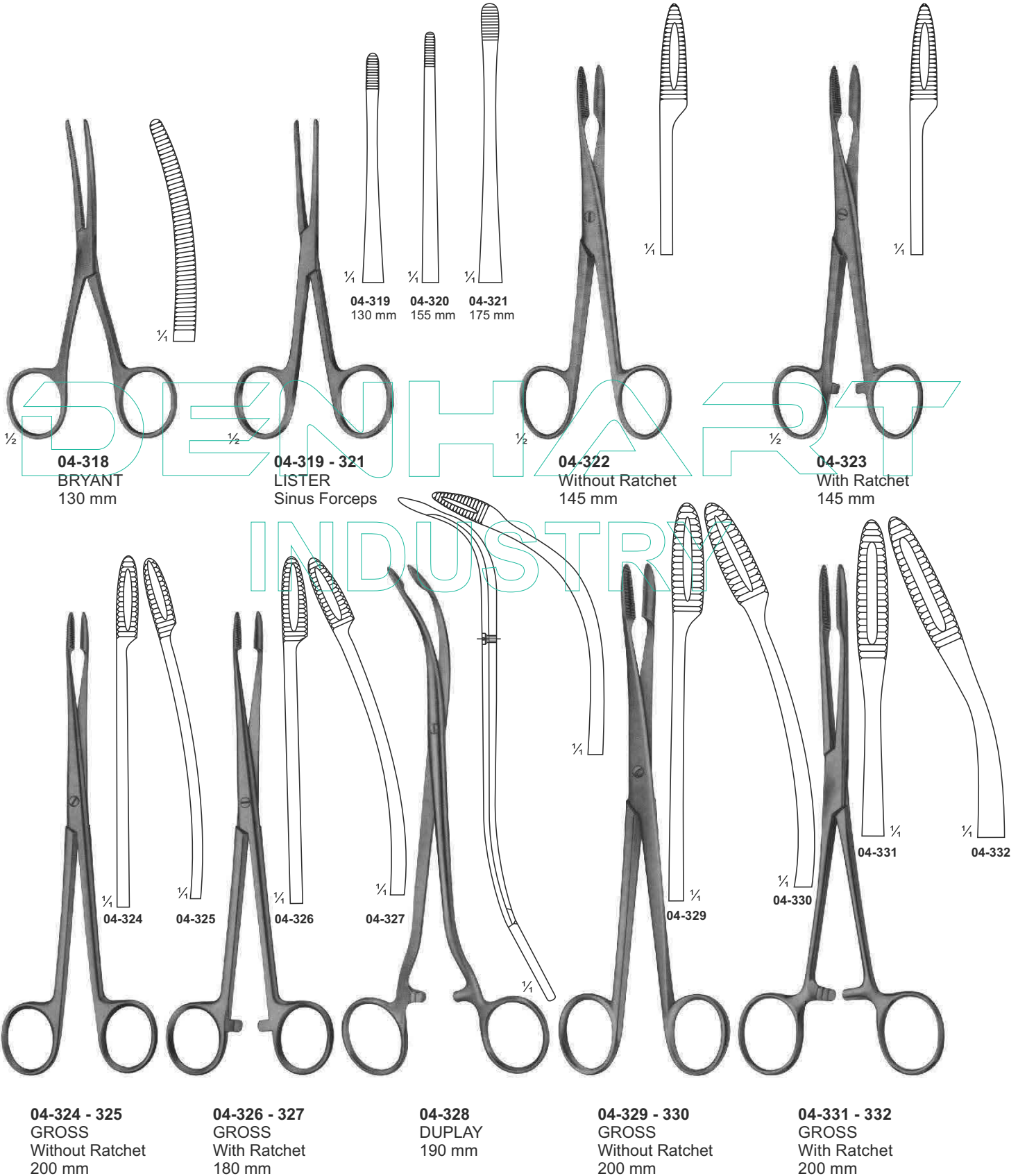



04-333 - 334
AESCULAP
220 mm

04-335 - 336
MAIER
Without Ratchet
265 mm

04-337 - 338
MAIER
With Ratchet
265 mm

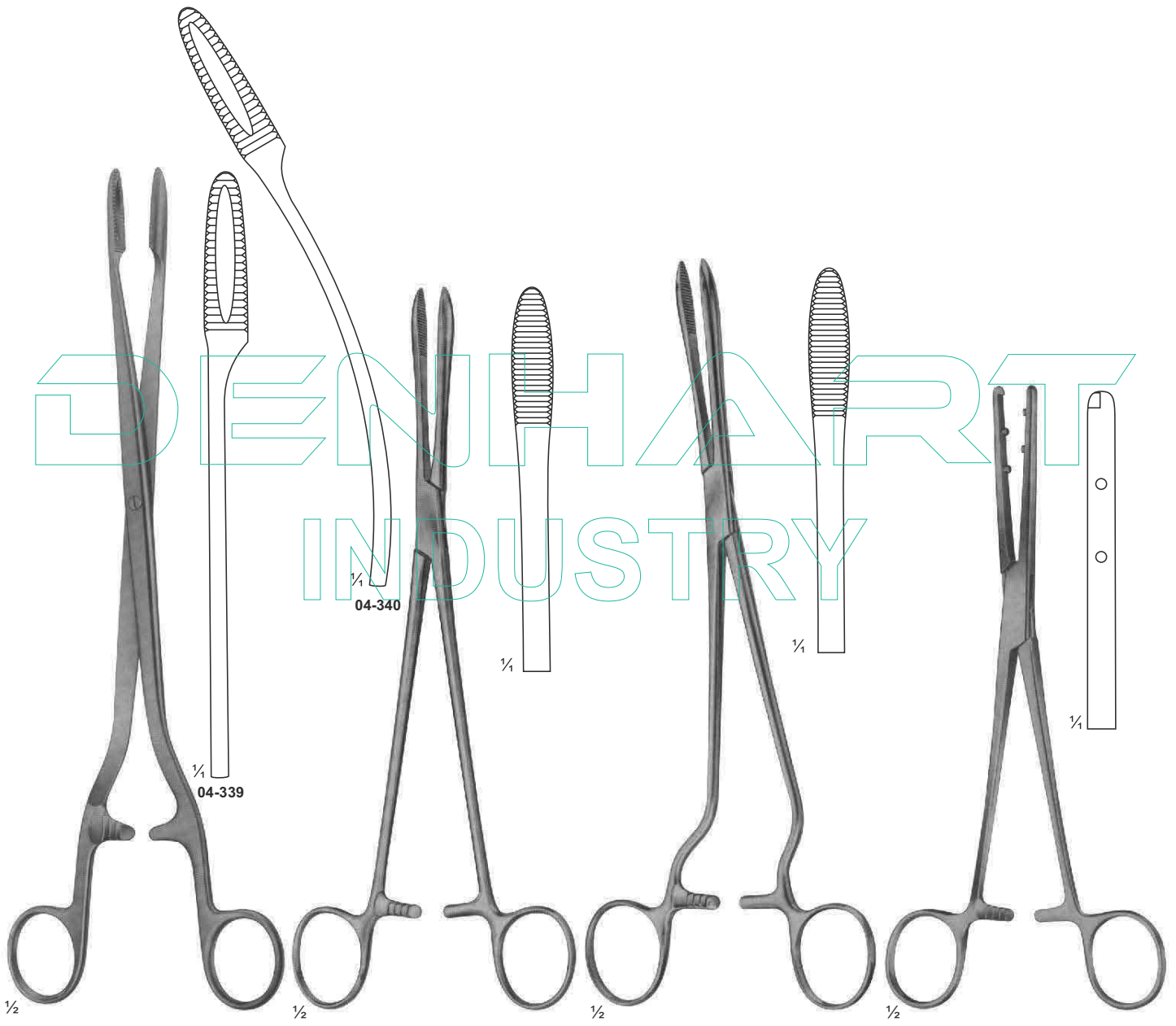

04-339 - 340
SIMS-MAIER
280 mm

04-341
COLLIN
240 mm

04-342
CHERON
Handles Laterally Angled
240 mm

04-343
EMMET
210 mm

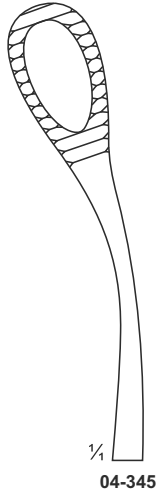
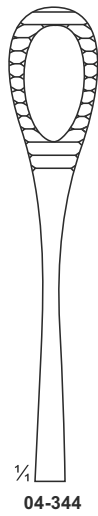
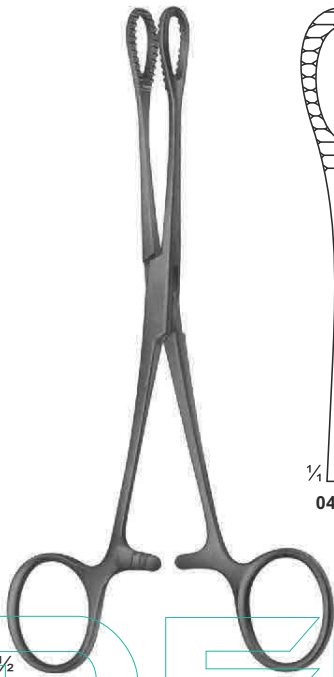

04-344 - 345
FOERSTER-BALLENGER
180 mm

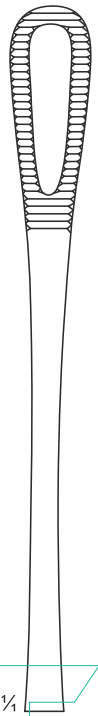
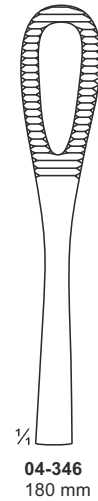

04-346 - 347
RAMPLEY

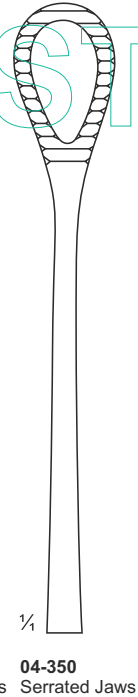
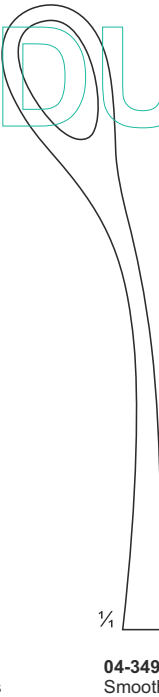
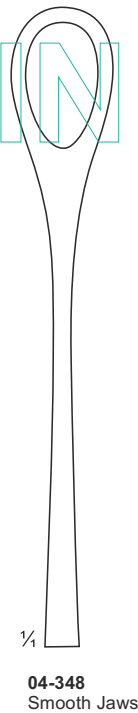
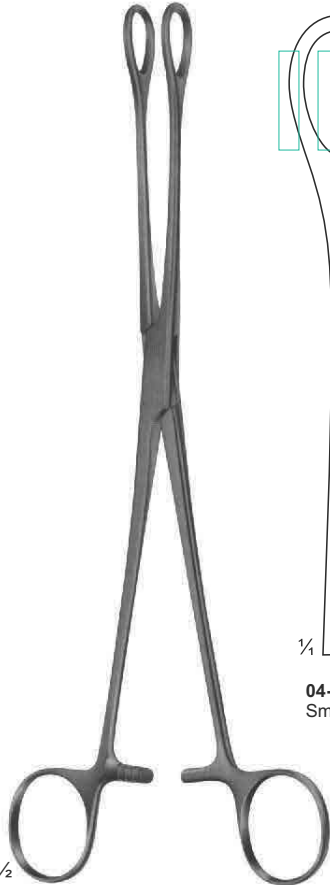

04-348 - 351
FOERSTER-BALLENGER
240 mm

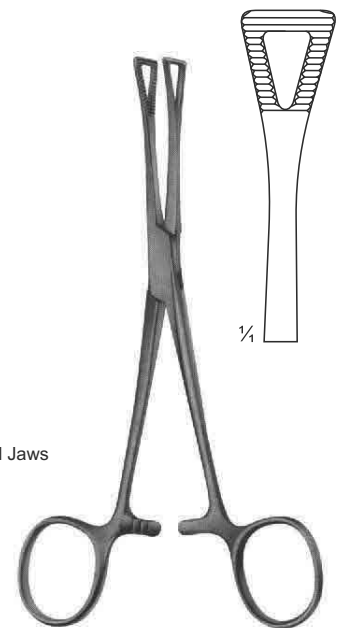

04-352
PENNINGTON
155 mm

Dressing, Sponge holding, Organ and Tissue Grasping Forceps

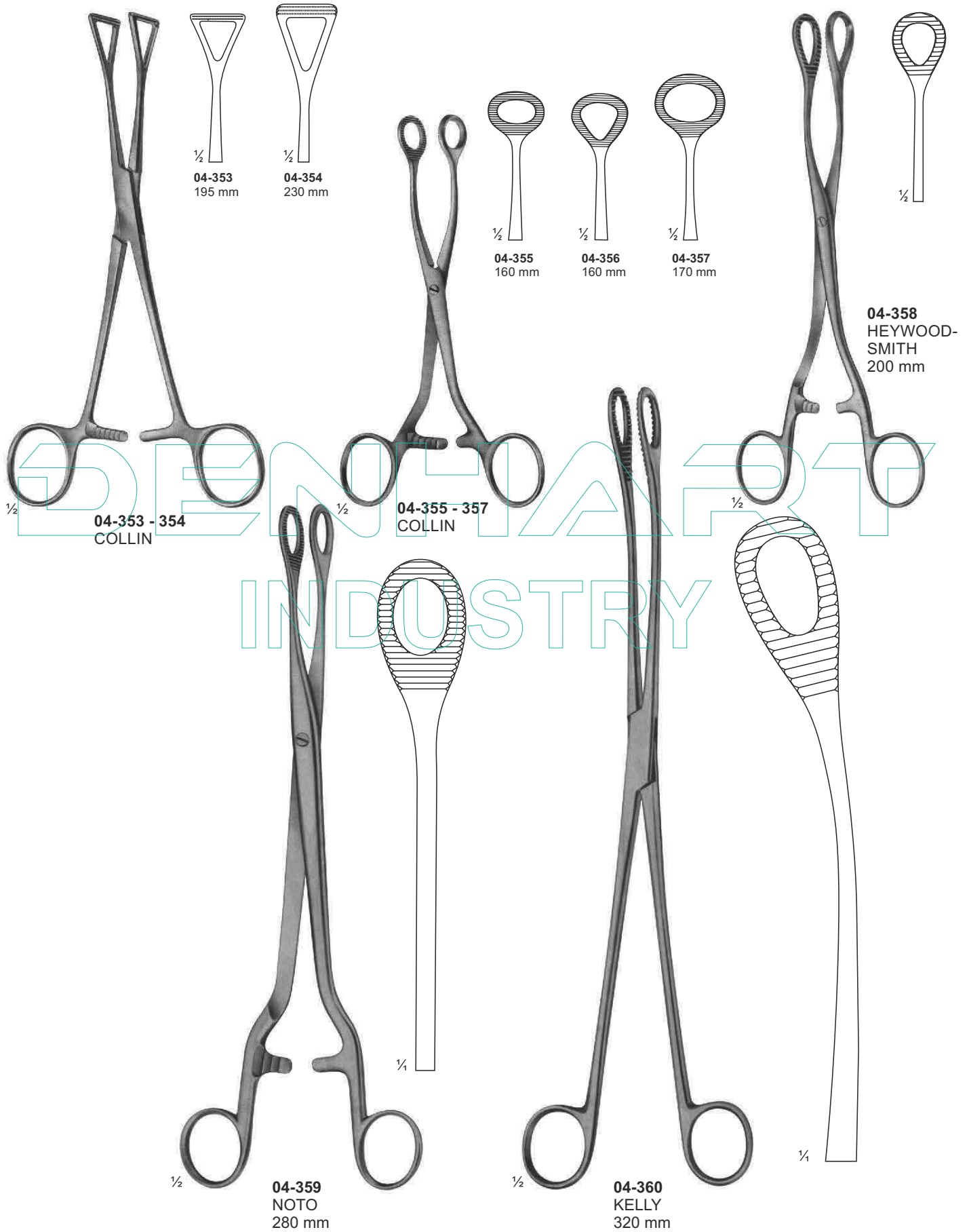



04-361 - 362
HERZ
155 mm

04-363
JACKSON
4 x 5 teeth
150 mm

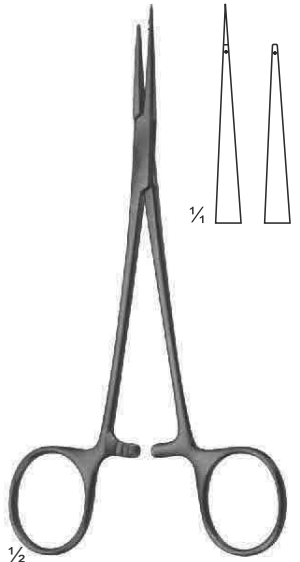

04-364
150 mm

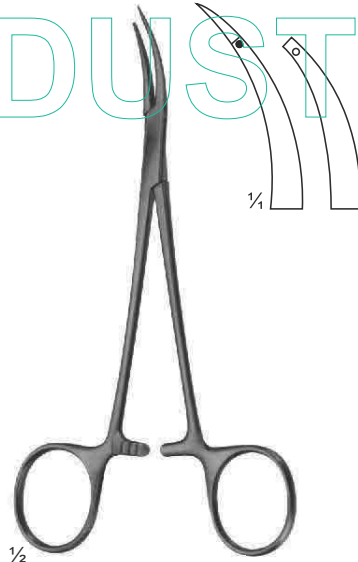

04-365
150 mm

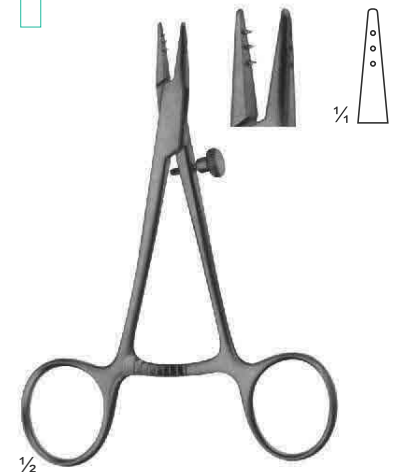

04-366
120 mm

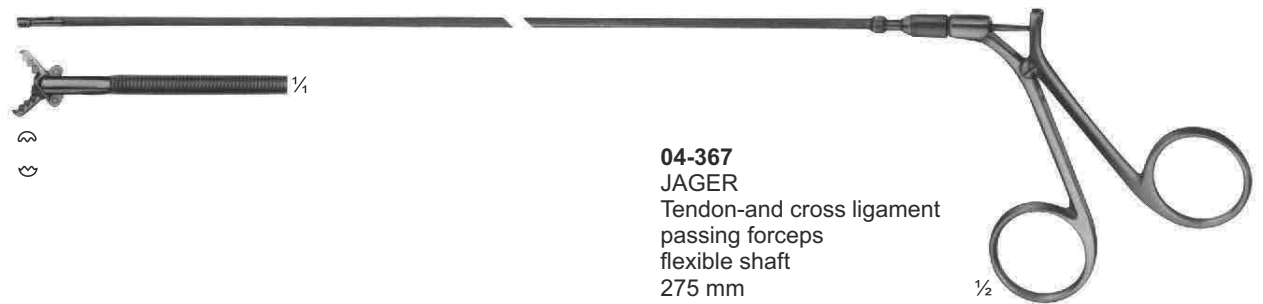

04-367
JAGER
Tendon-and cross ligament
passing forceps
flexible shaft
275 mm

Artery Traction - and Tissue Grasping Forceps

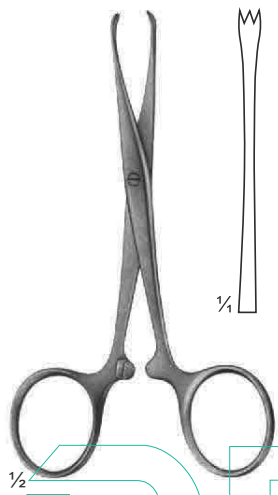

04-368
CHAPUT
2 x 3 teeth
125 mm

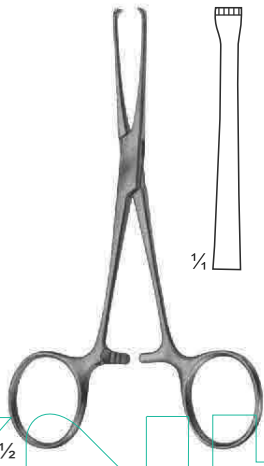

04-369
BABY-ALLIS
4 x 5 teeth
130 mm

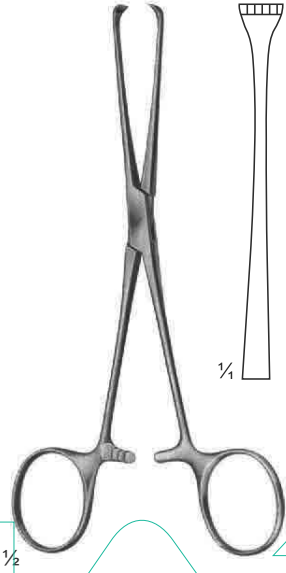

04-370
BOYS-ALLIS
5 x 6 teeth
155 mm

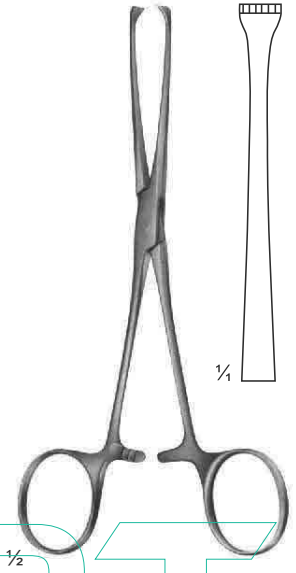

04-371
ALLIS
5 x 6 teeth
155 mm

INDUSTRY

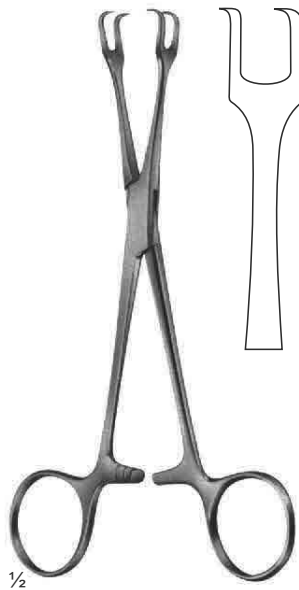

04-372
LAHEY
135 mm

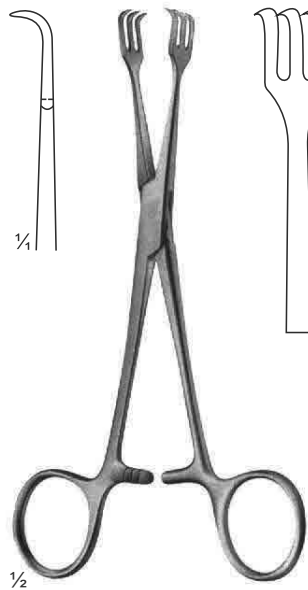

04-373
LAHEY
135 mm

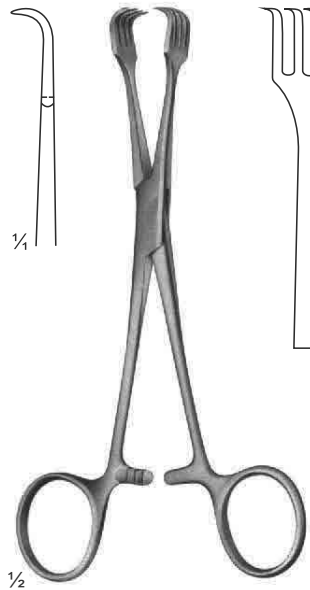

04-374
BRAUN
155 mm

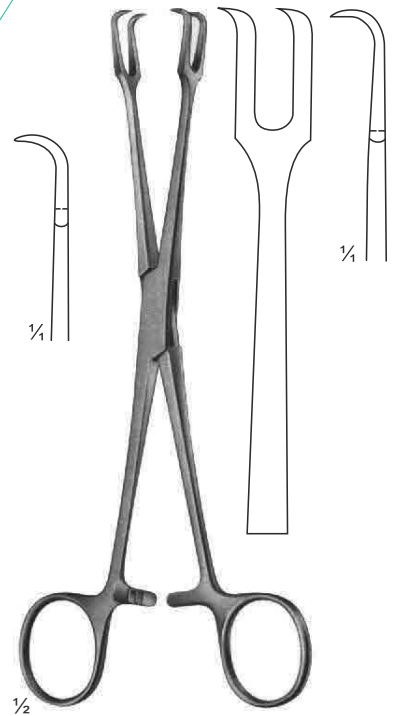

04-375
MUSEUX
200 mm



04-376
AESCULAP
260 mm

04-377
PRATT
270 mm

04-378
TIEMANN
Bullet forceps
220 mm

04-379
SCHRODER
250 mm

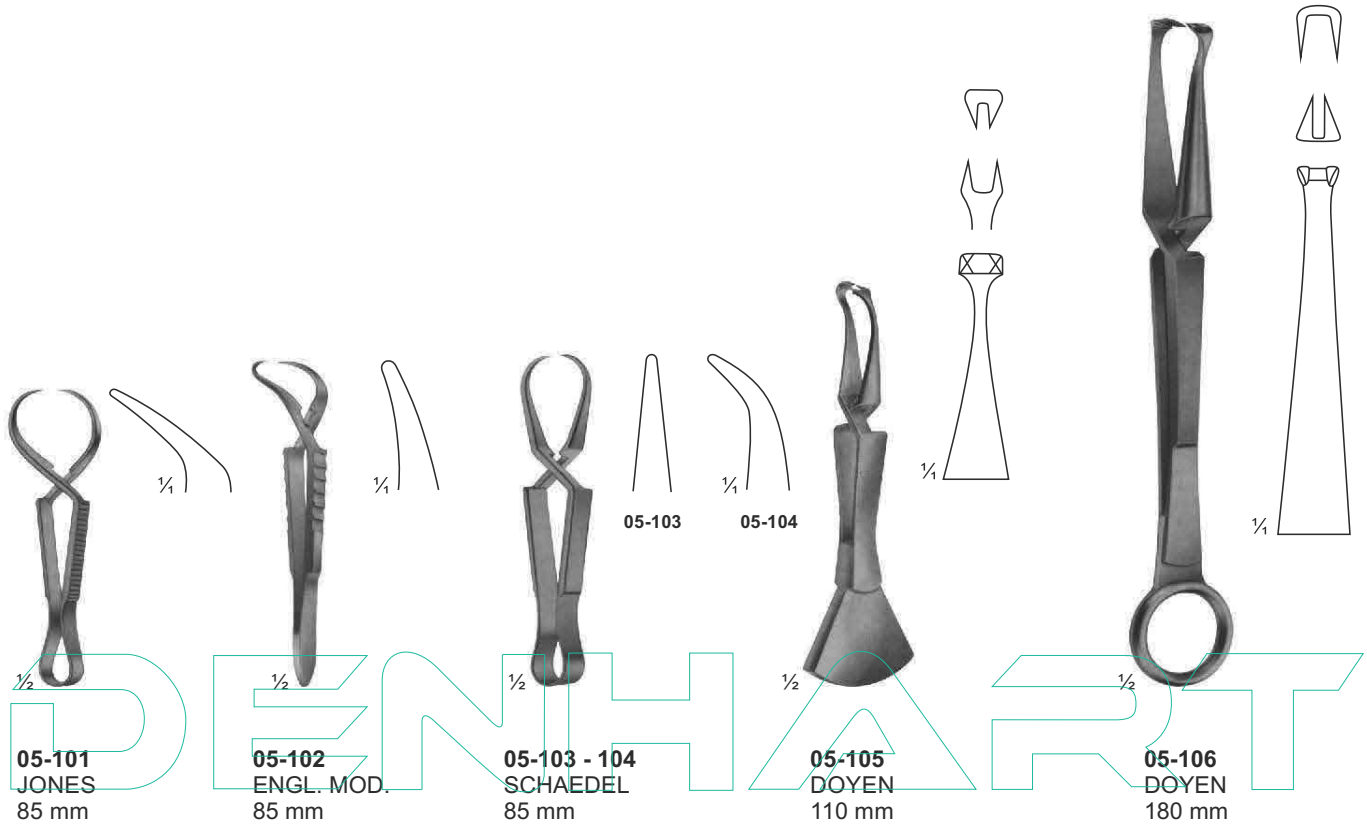

INDUSTRY

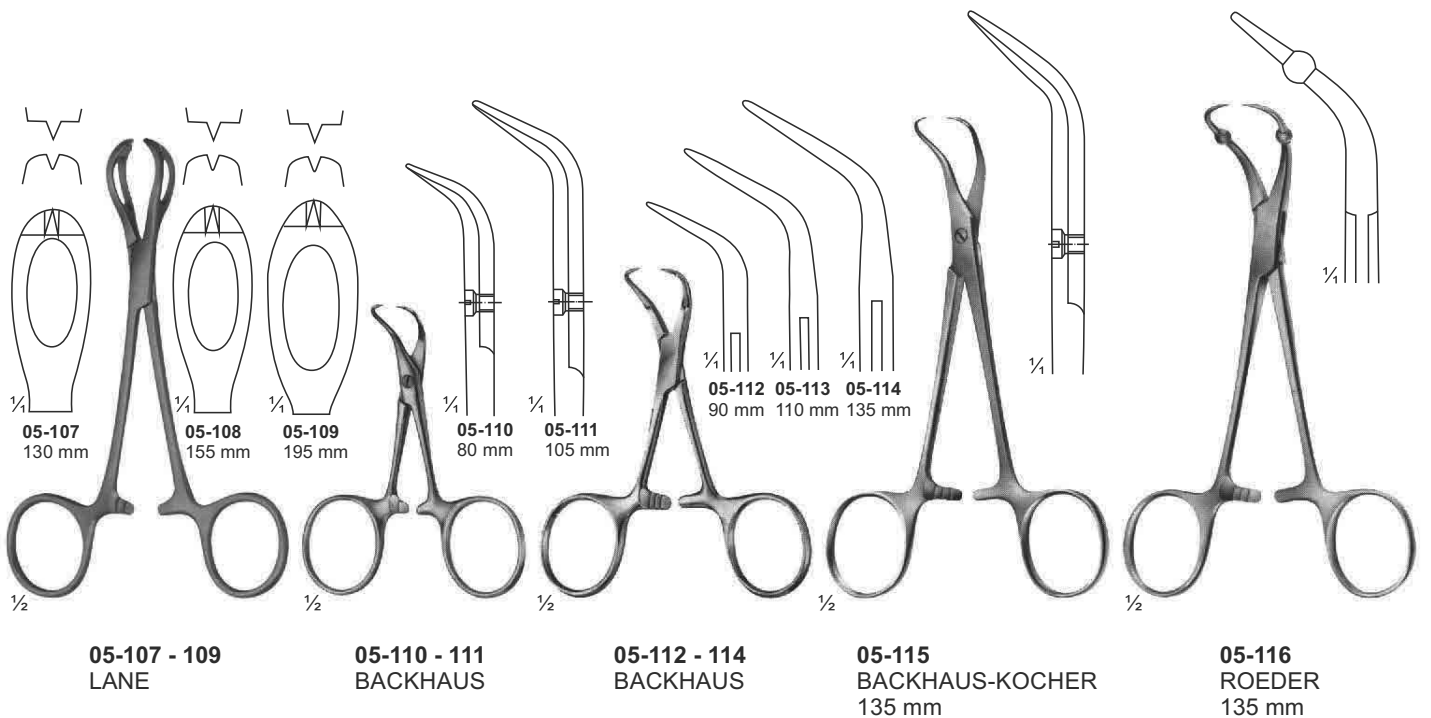

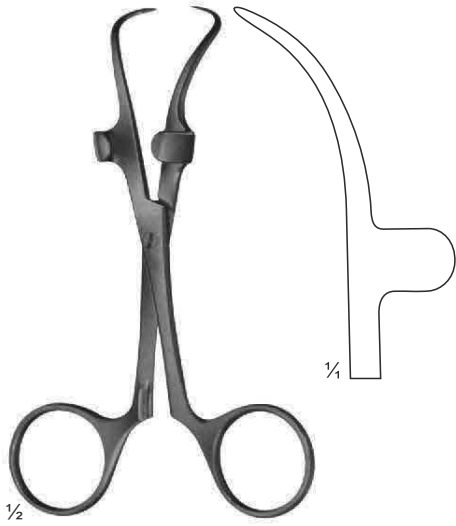

05-117
ROBIN
with holders for tubing
up to 13 mm
135 mm



05-118
with clip for tubing
up to 15 mm
110 mm

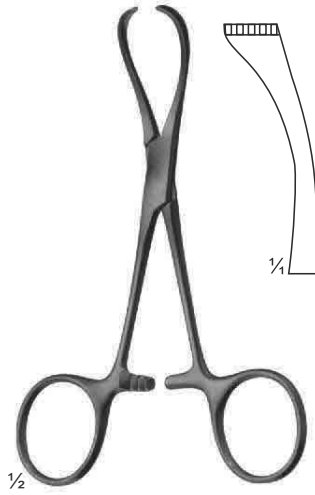

05-119
LORNA
non perforating
130 mm

DENHART
INDUSTRY

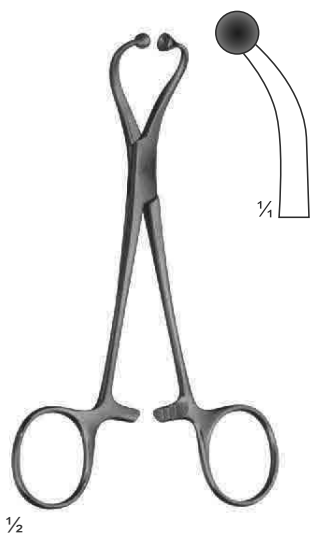

05-120
for paper cloths
140 mm



05-121
BUNT
105 mm



05-122
MAYO
140 mm

Closing force

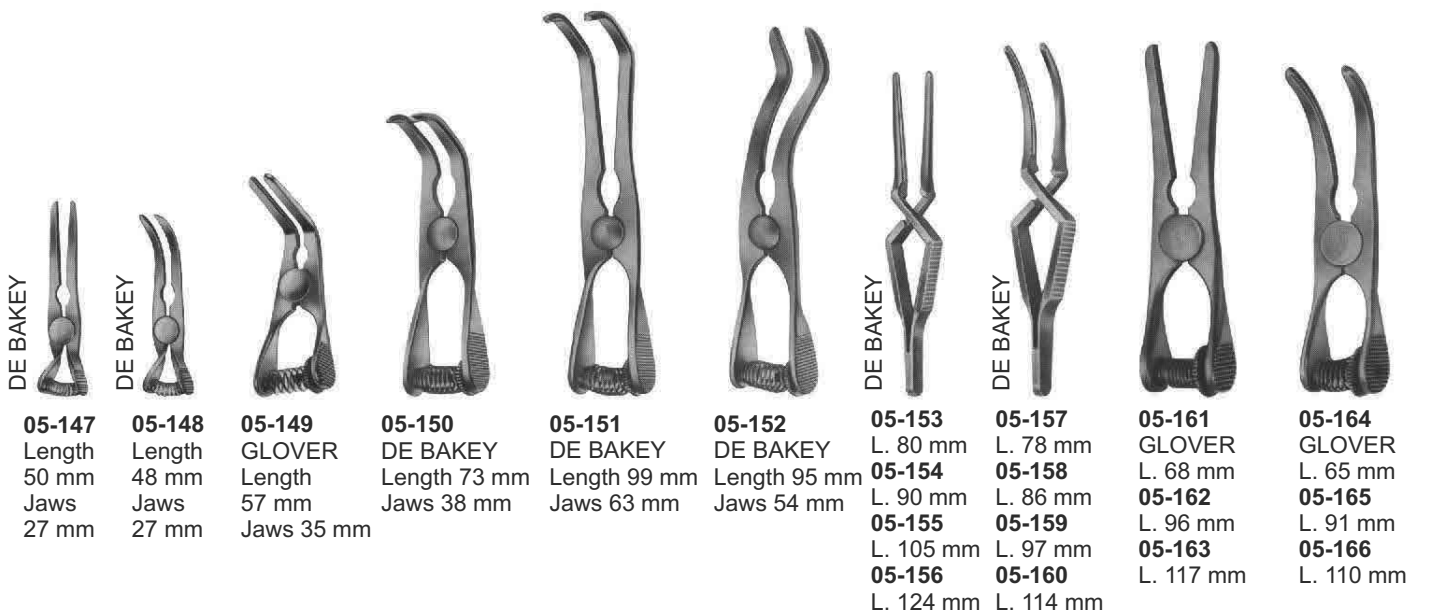
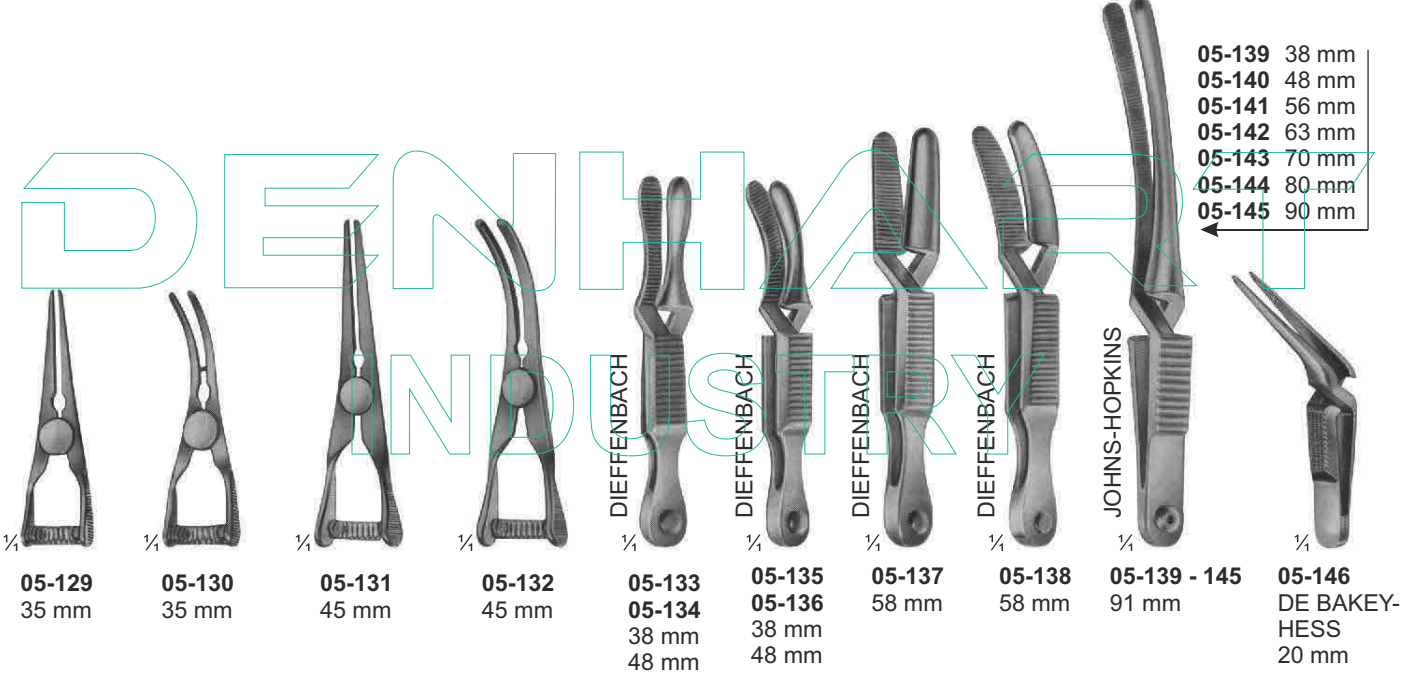
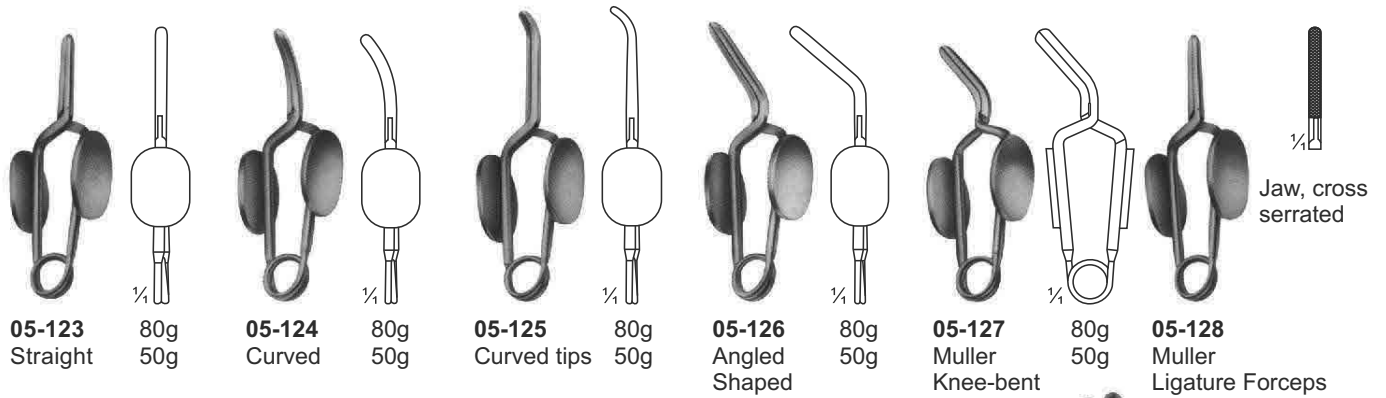

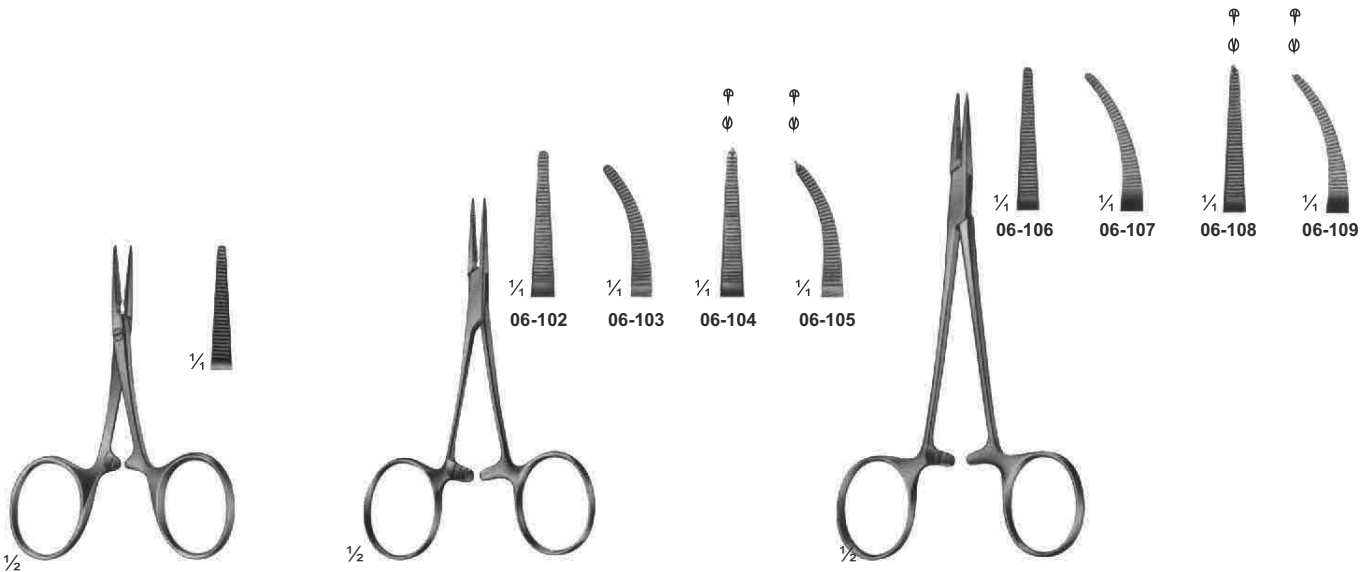

06-101
CARREL
85 mm

06-102 - 105
BABY-MOSQUITO
(HARTMANN)
100 mm

06-106 - 109
MICRO-HALSTED
125 mm

DENHART

INDUSTRY



06-110 - 113
HALSTED-MOSQUITO
125 mm

06-114 - 115
PROVIDENCE-HOSPITAL
140 mm

06-116 - 117
KELLY
140 mm

06-118 - 119
DANDY
Curved sideways
140 mm

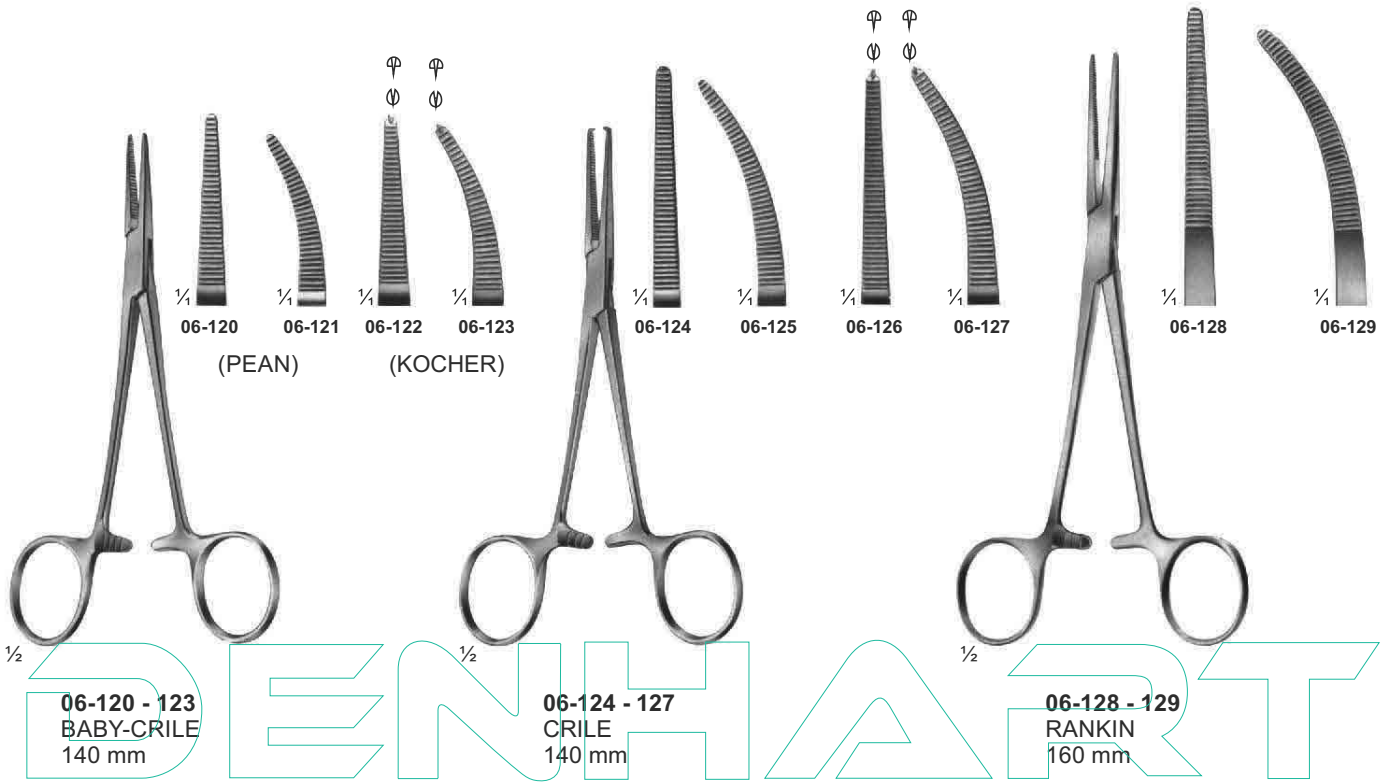

INDUSTRY

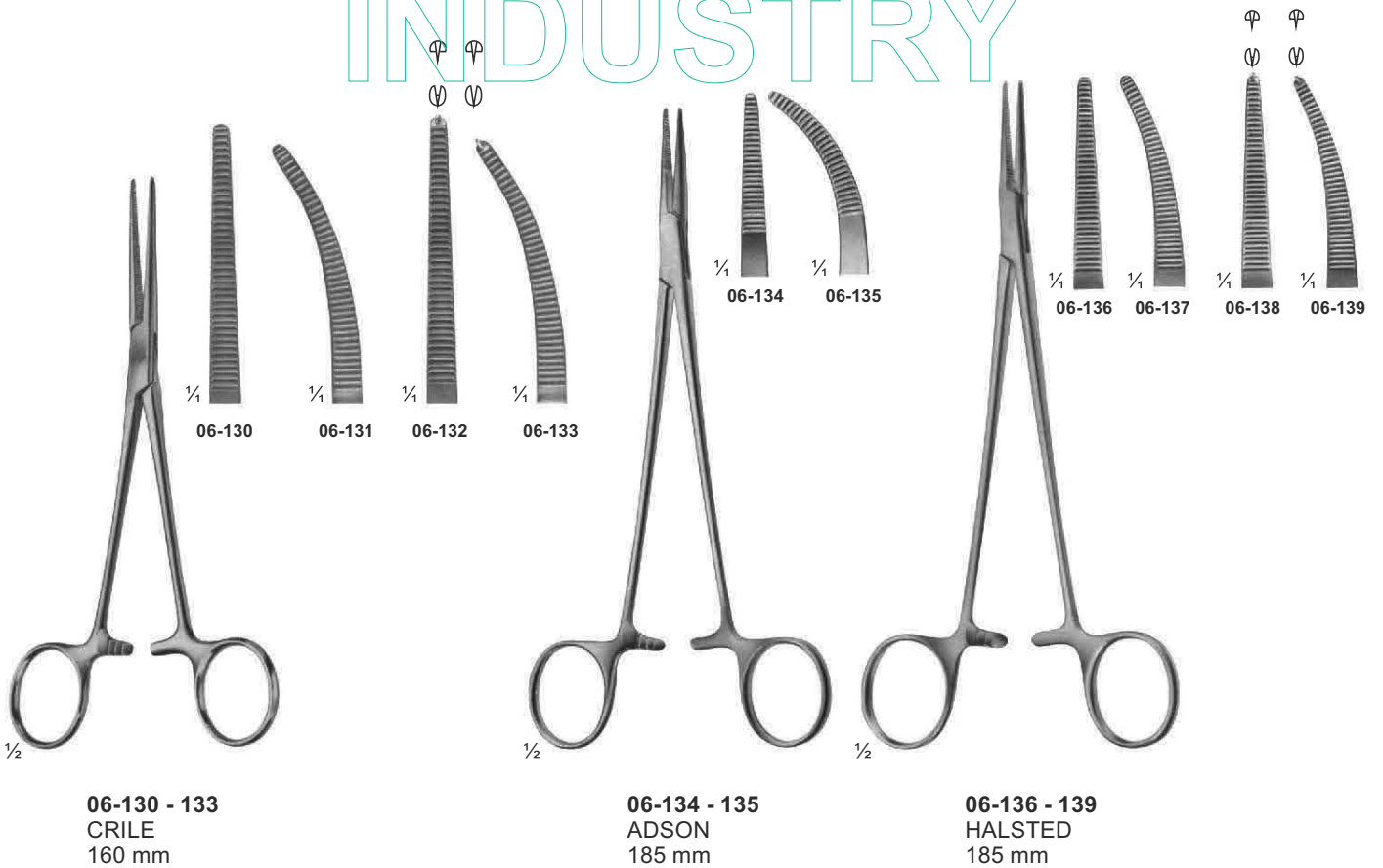

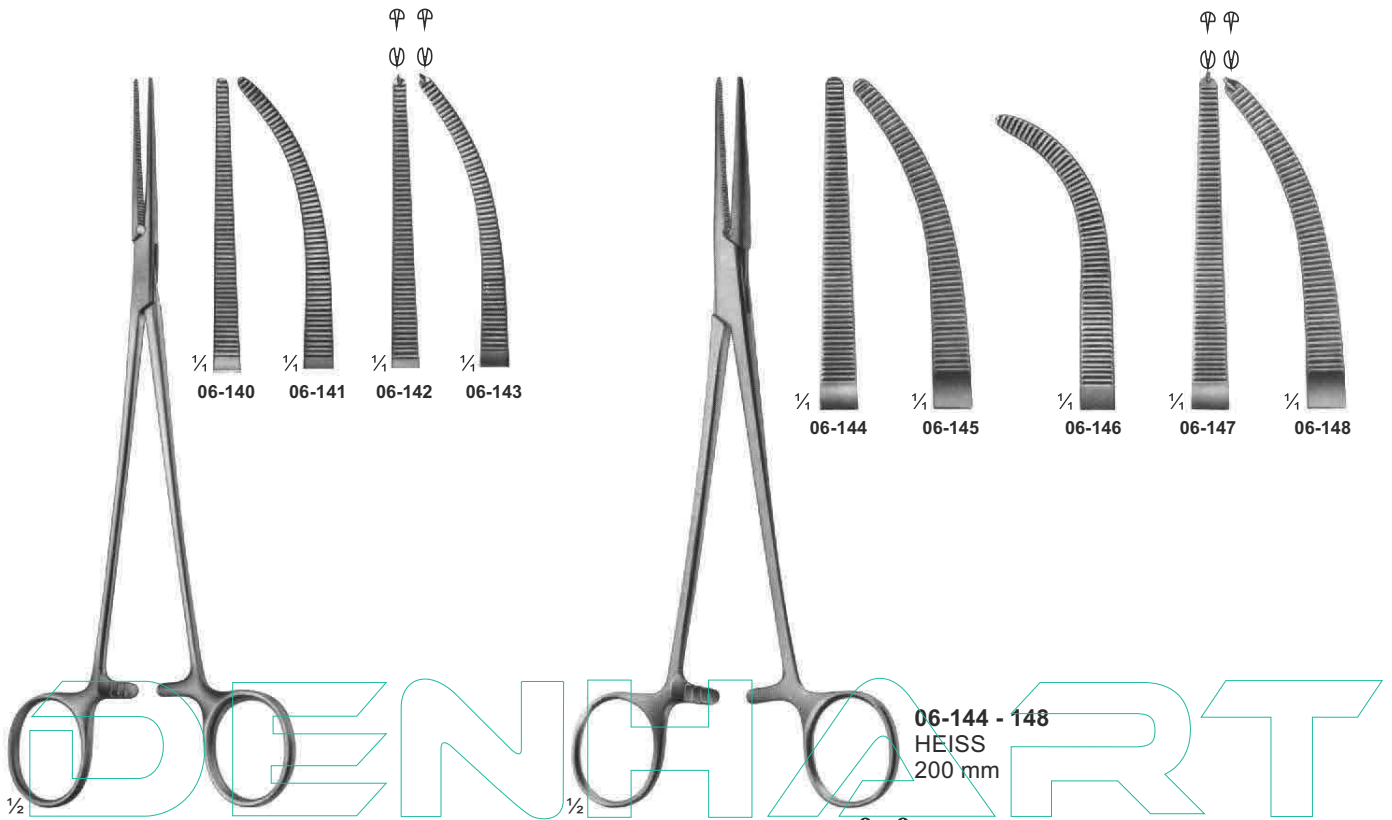

06-140 - 143
HALSTED-MOSQUITO
200 mm

06-144 - 148
HEISS
200 mm

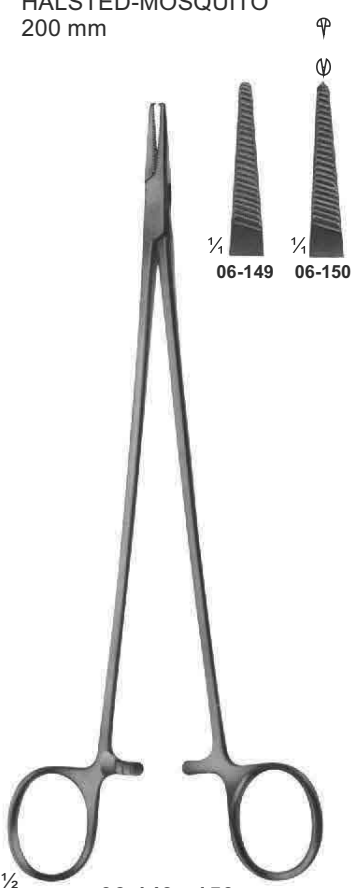

06-149 - 150
HALSTED
215 mm

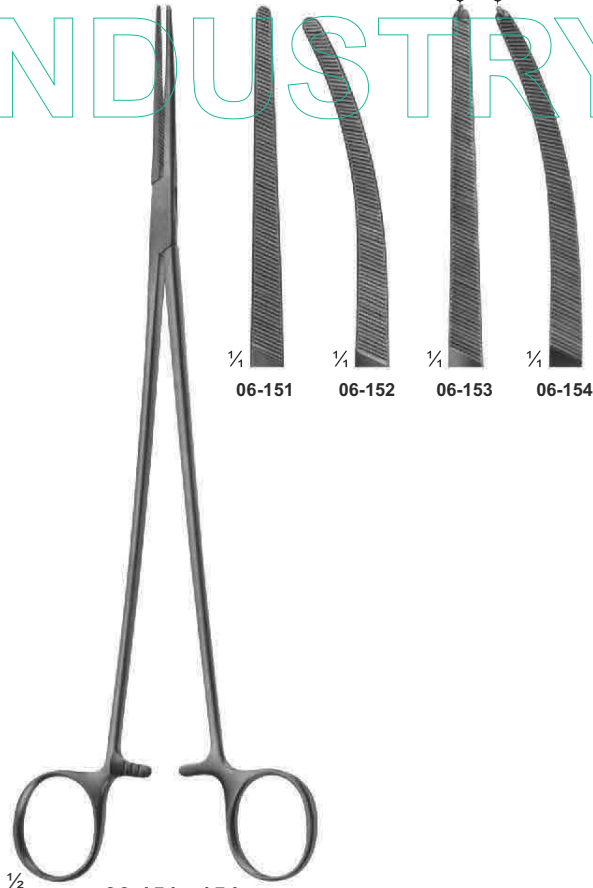

06-151 - 154
BENGOLEA
245 mm

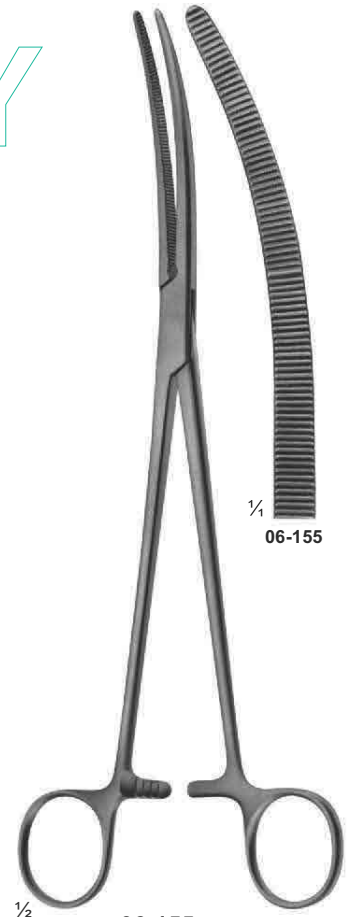

06-155
CRAFOORD
245 mm

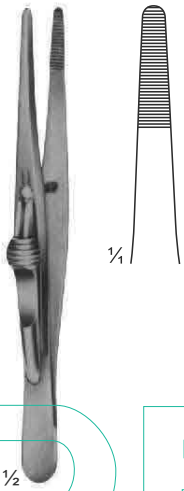

06-156
FRICKE
Artery forceps
130 mm

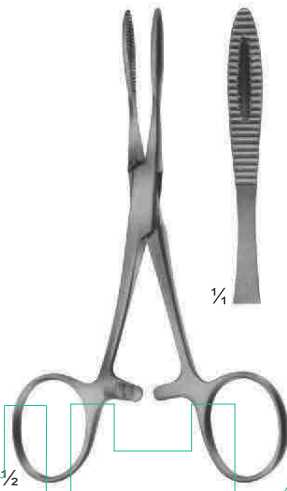

06-157
KRONLEIN
130 mm

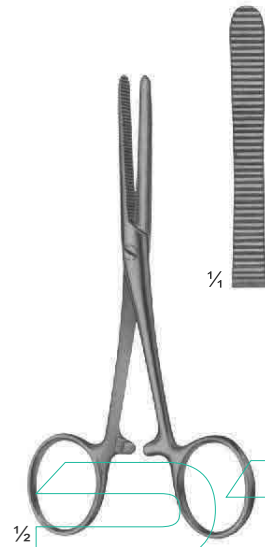

06-158
PEAN
125 mm

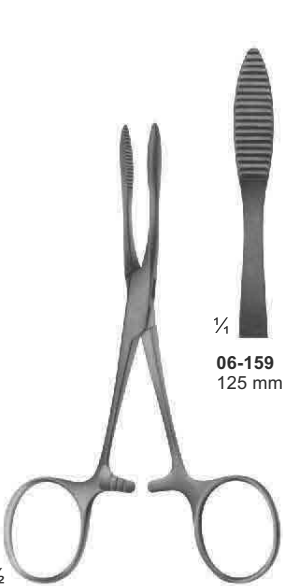

06-159 - 160
PEAN



06-160
140 mm

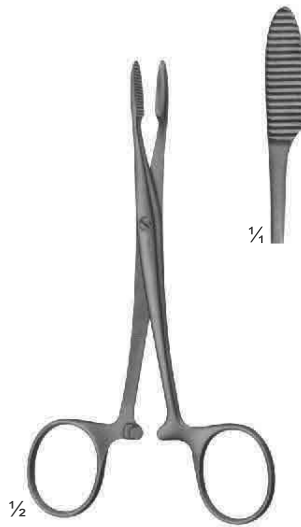

06-161
PEAN

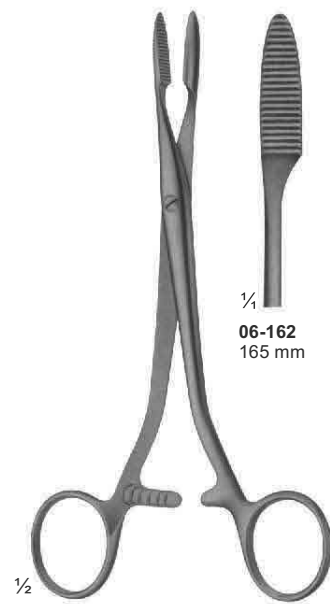

06-162 - 163
PEAN



06-163
185 mm

DENHART
INDUSTRY

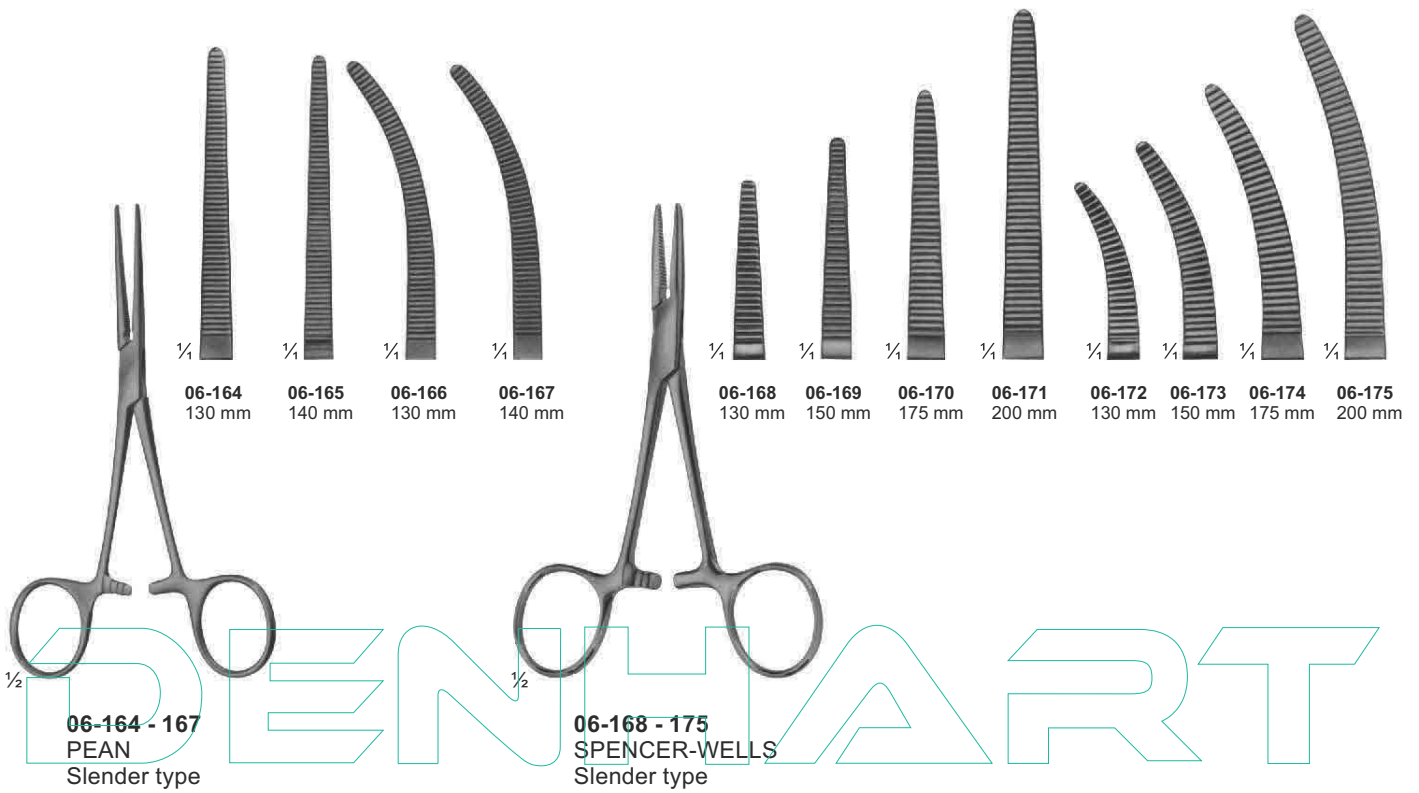

INDUSTRY

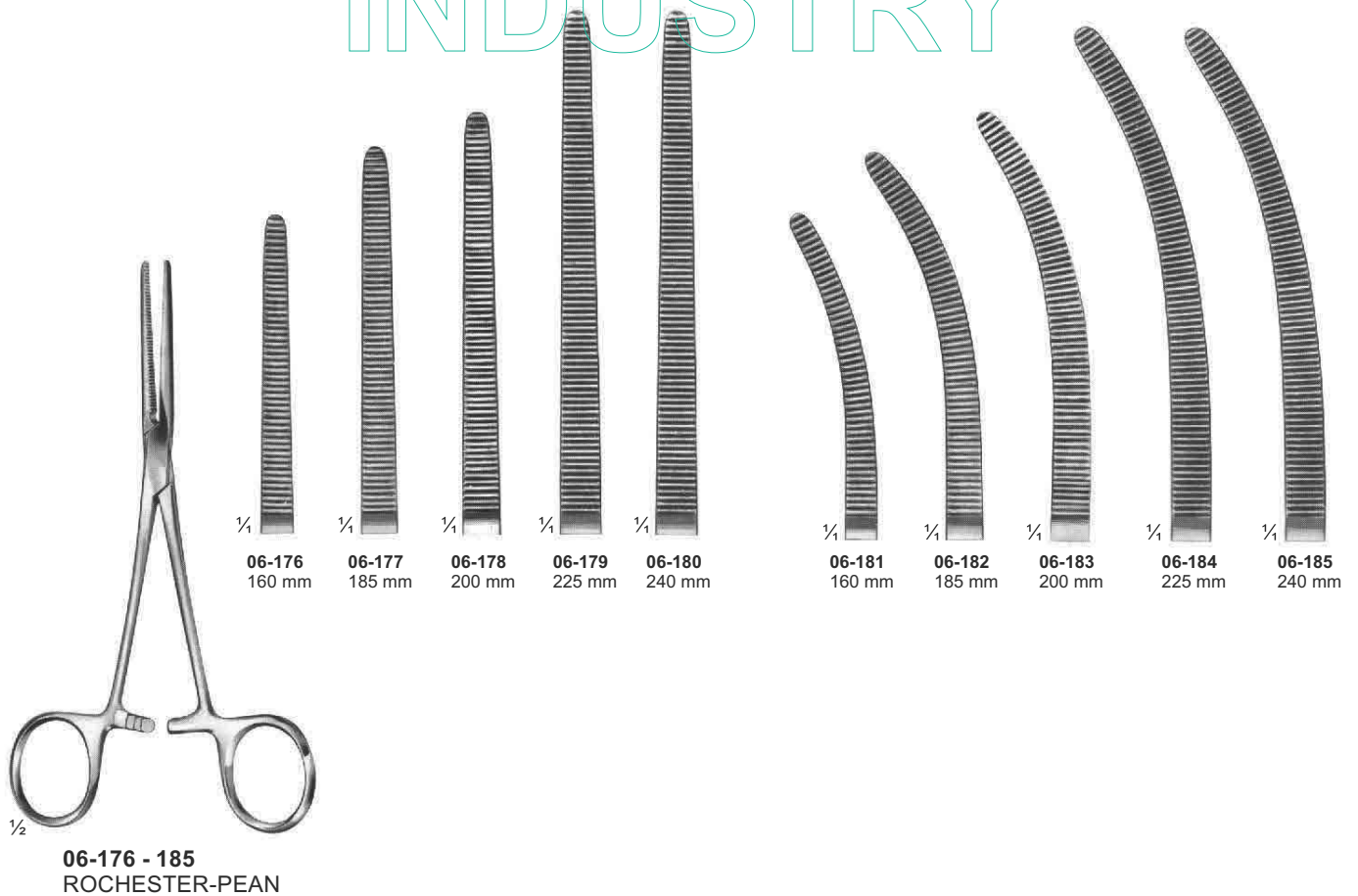

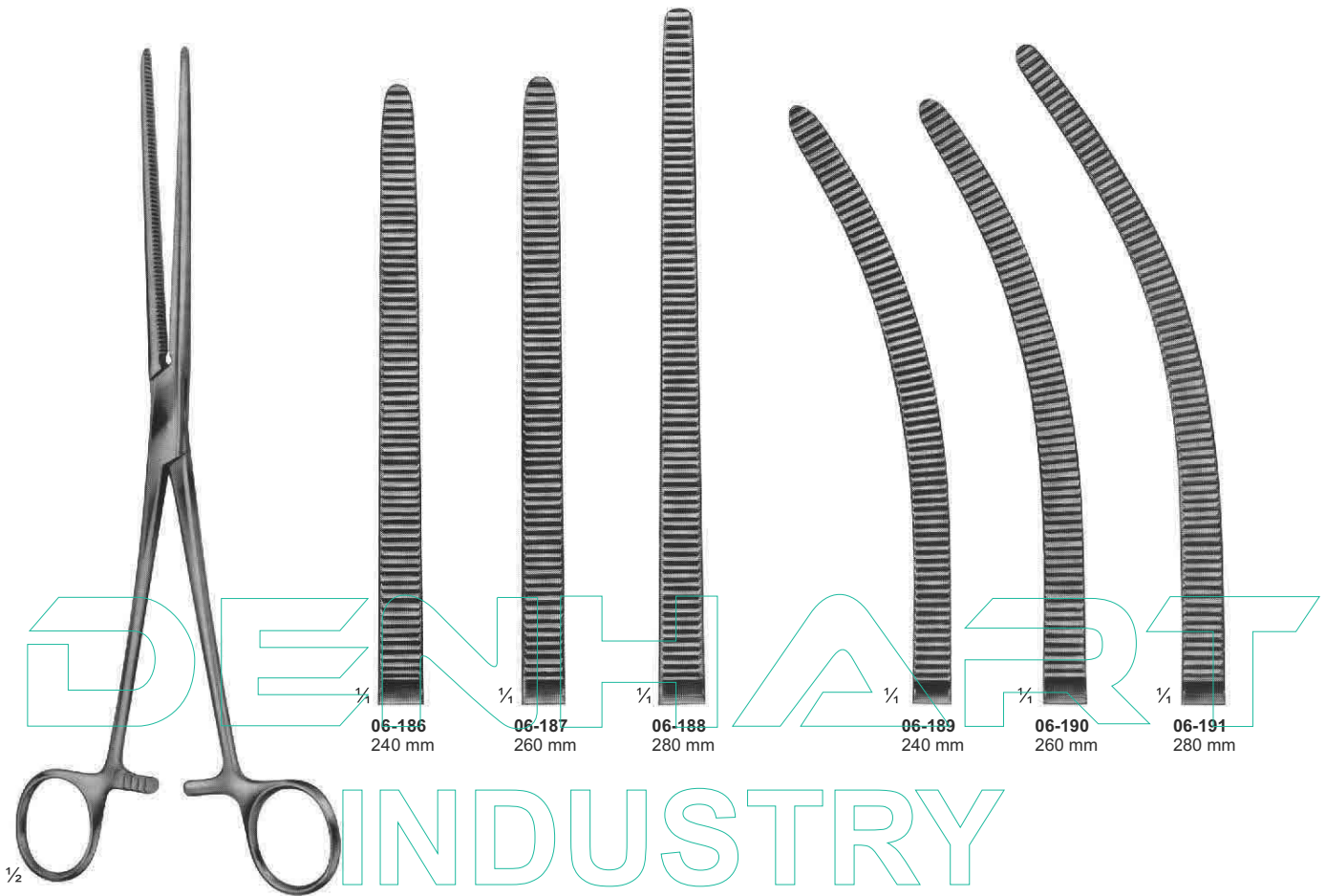

06-186 - 191
PEAN

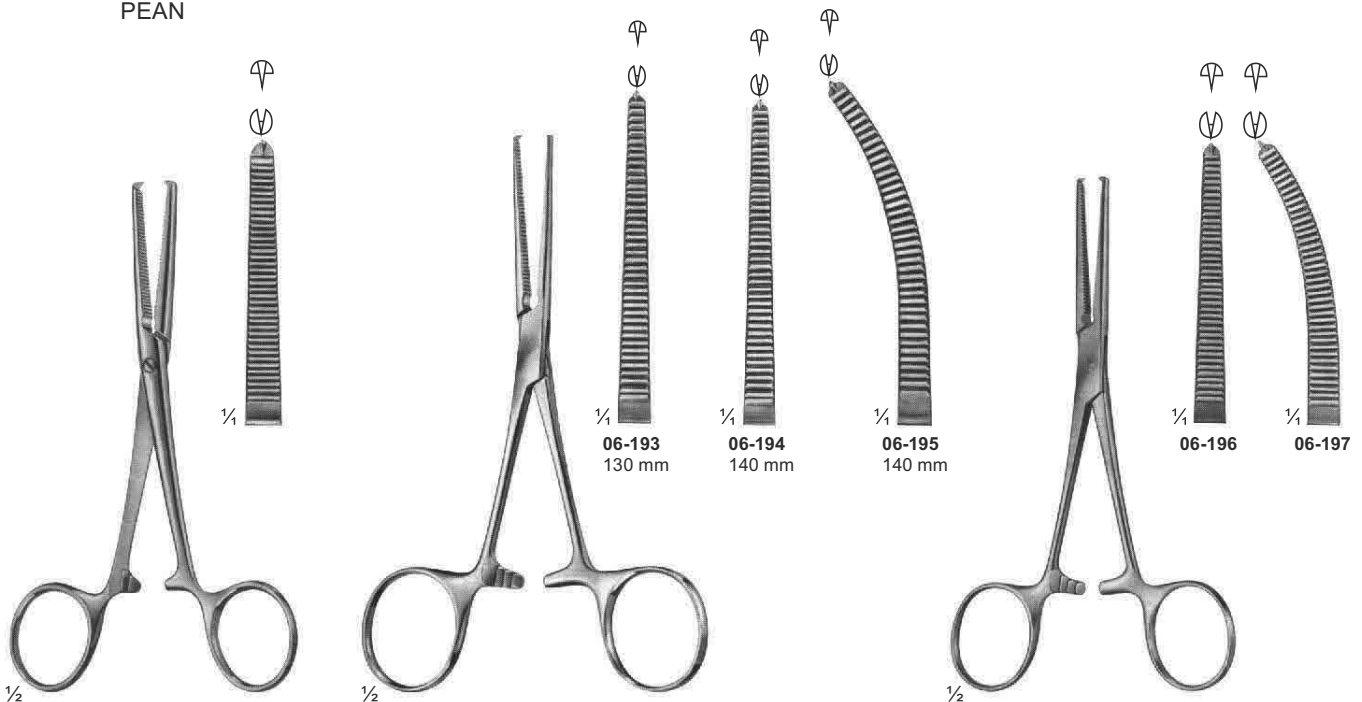

06-192
KOCHER
Strong Pattern
145 mm

06-193 - 195
KOCHER

06-196 - 197
ROCHESTER-OCHSNER
140 mm

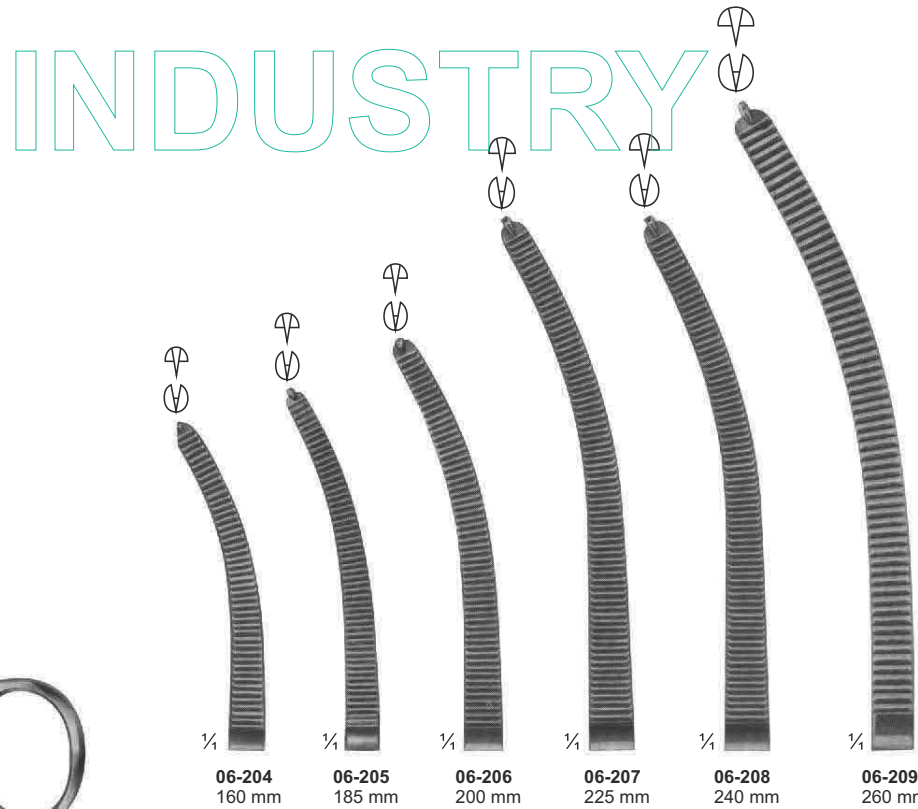
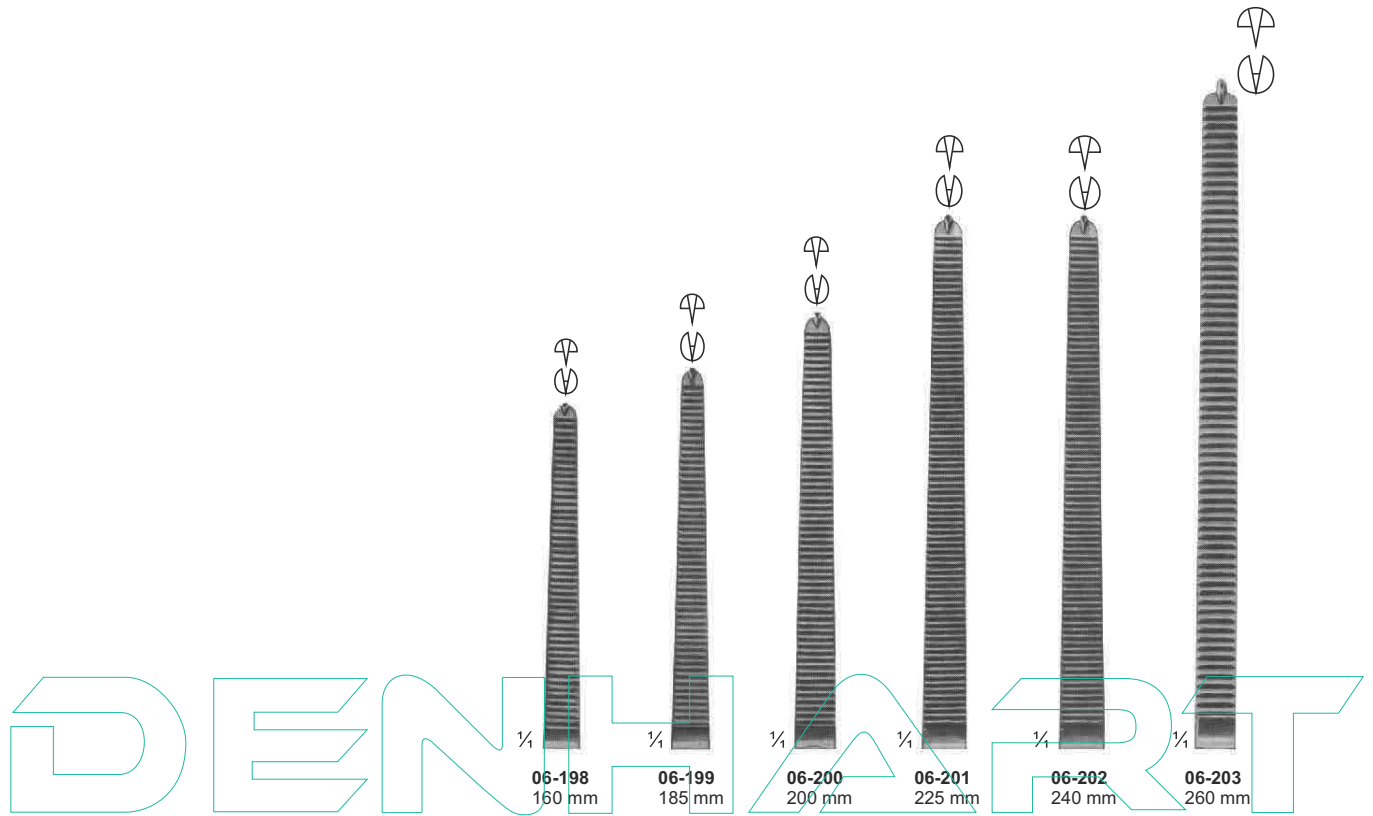

06-198 - 209
KOCHER-OCHSNER

Haemostatic Forceps, Special Pattern, Tonsil Forceps

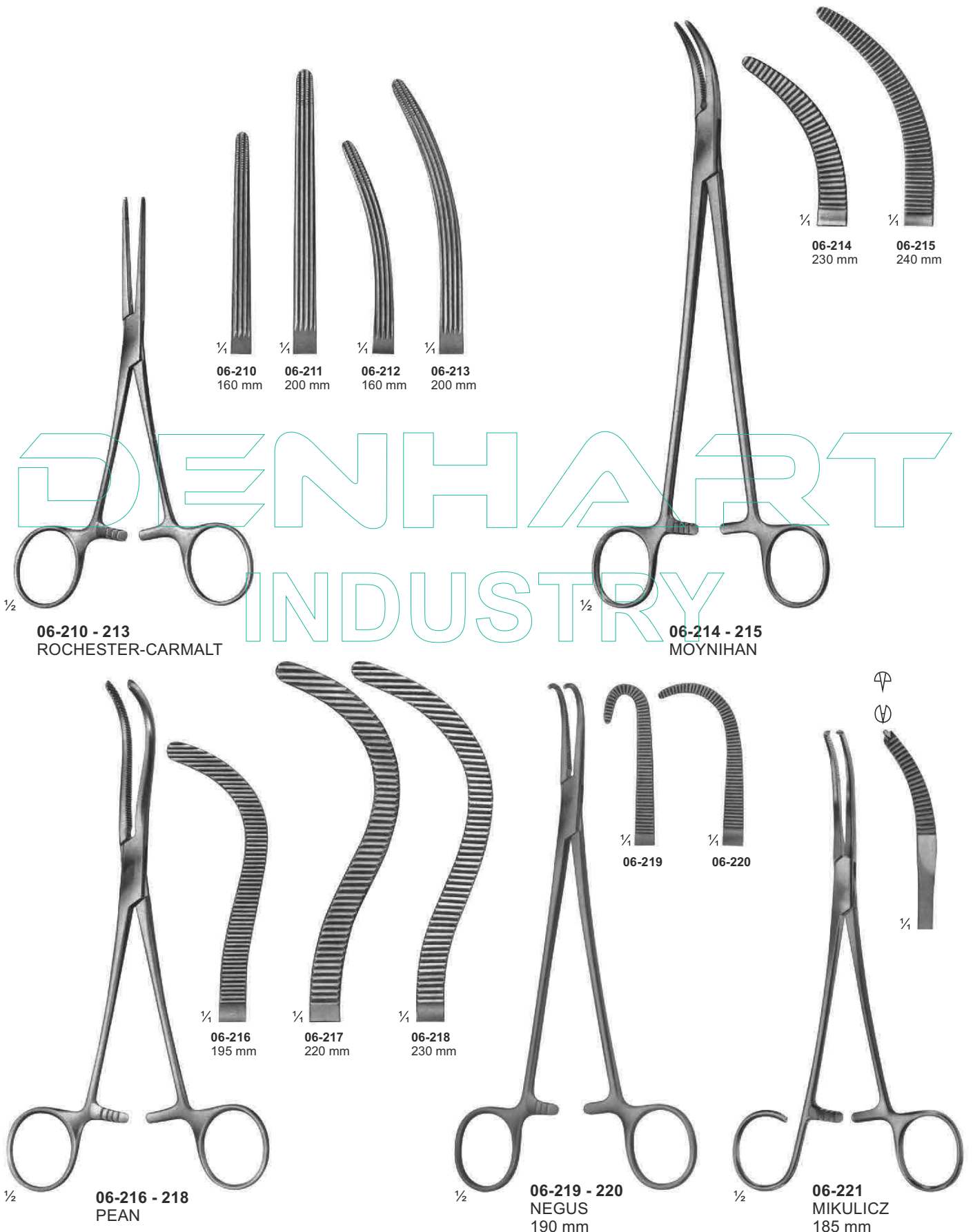

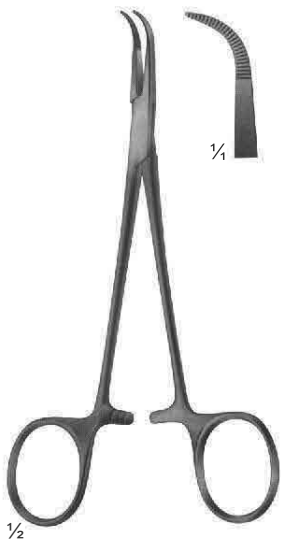

06-222
MICRO-ADSON
140 mm



06-223
BABY-OVERHOLT
135 mm



06-224 - 225
BABY-MIXTER

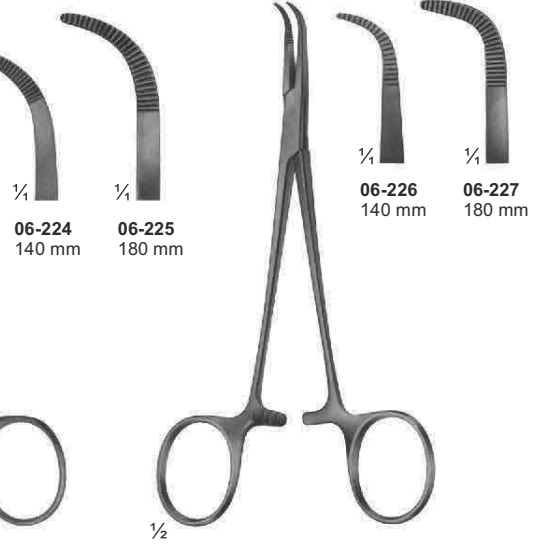

06-226 - 227
BABY-ADSON

INDUSTRY

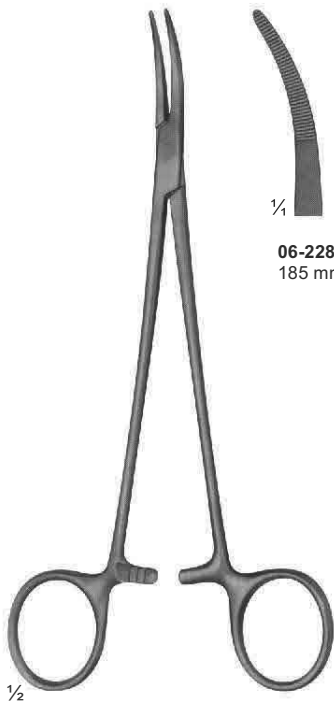

06-228
NISSEN

06-228
185 mm



06-229 - 230
YASARGIL
195 mm

06-229

06-230



06-231
OVERHOLT-MIXTER

06-231
205 mm

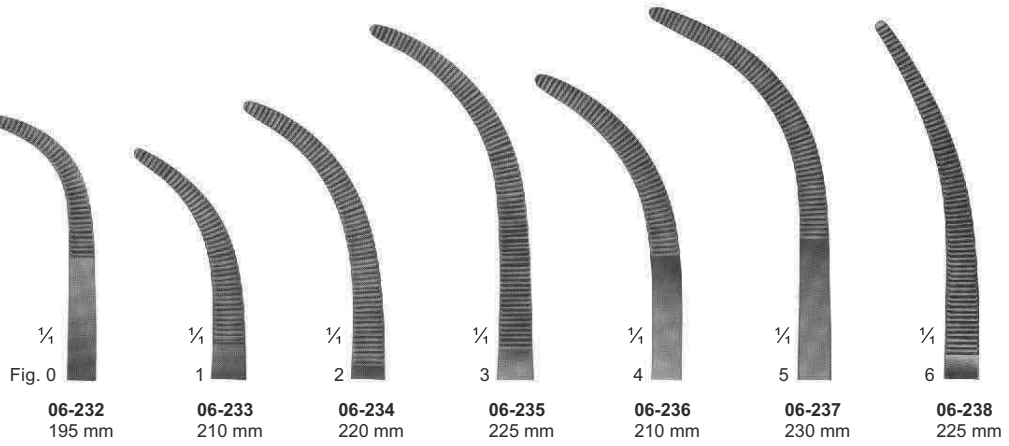
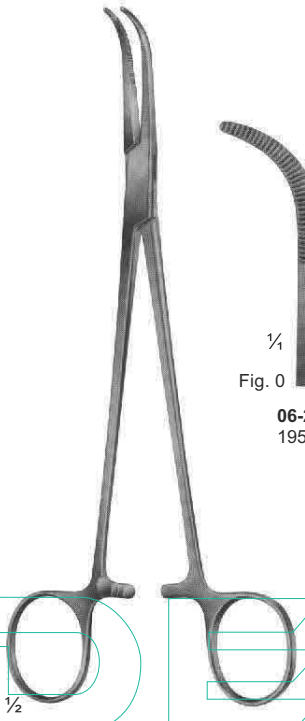

06-239
260 mm
06-240
270 mm
06-241
275 mm
06-242
270 mm
06-243
280 mm

DENHART
INDUSTRY

06-232 - 243
OVERHOLT-GEISSENDOERFER

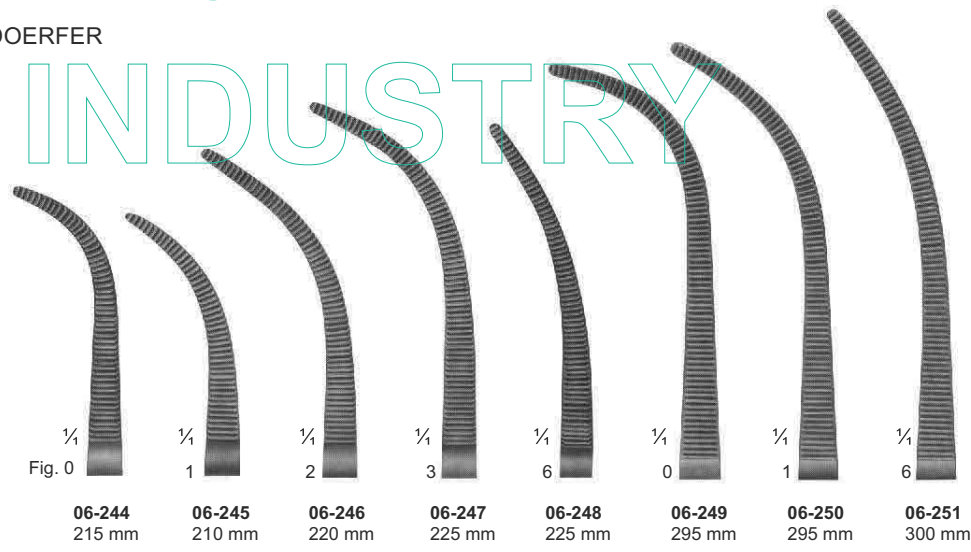

06-244 - 251
OVERHOLT
fine pattern

Dissecting- and Ligature Forceps

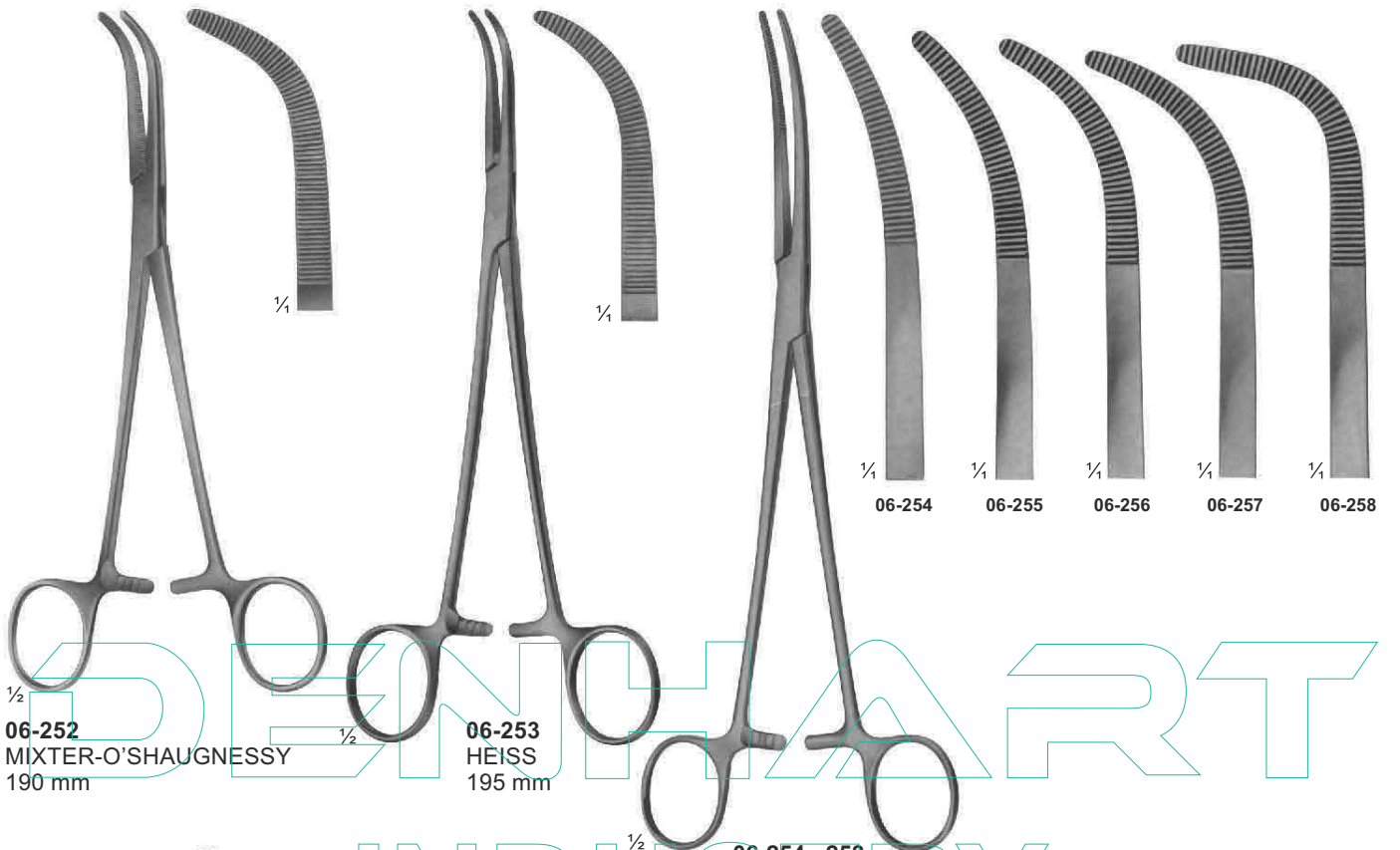

06-252
MIXTER-O'SHAUGHNESSY
190 mm

06-253
HEISS
195 mm

06-254 - 258
RUMEL
240 mm

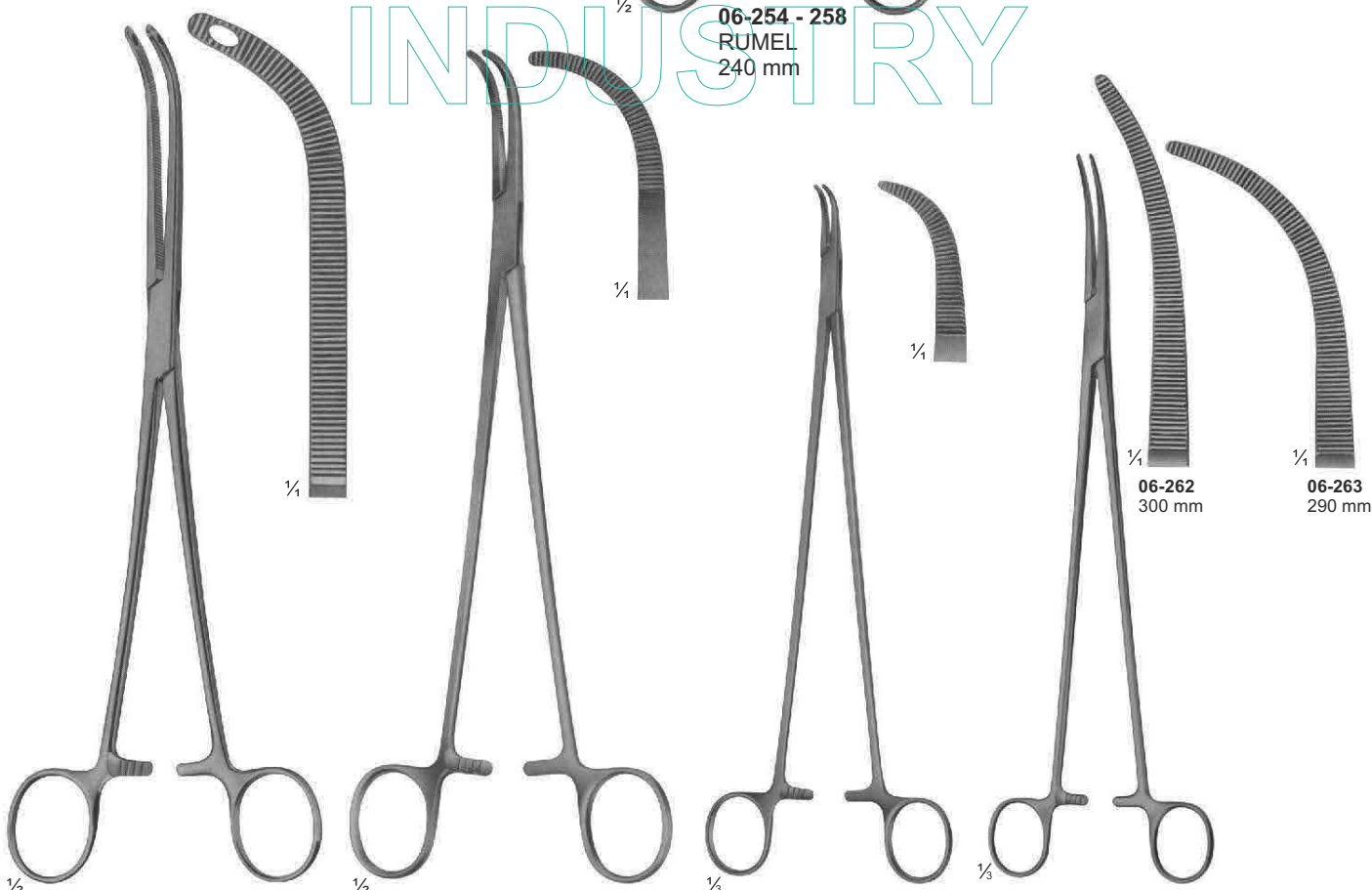

06-259
FINOCHIETTO
245 mm

06-260
MIXTER
230 mm

06-261
LAWRENCE
270 mm

06-262 - 263
ZENKER

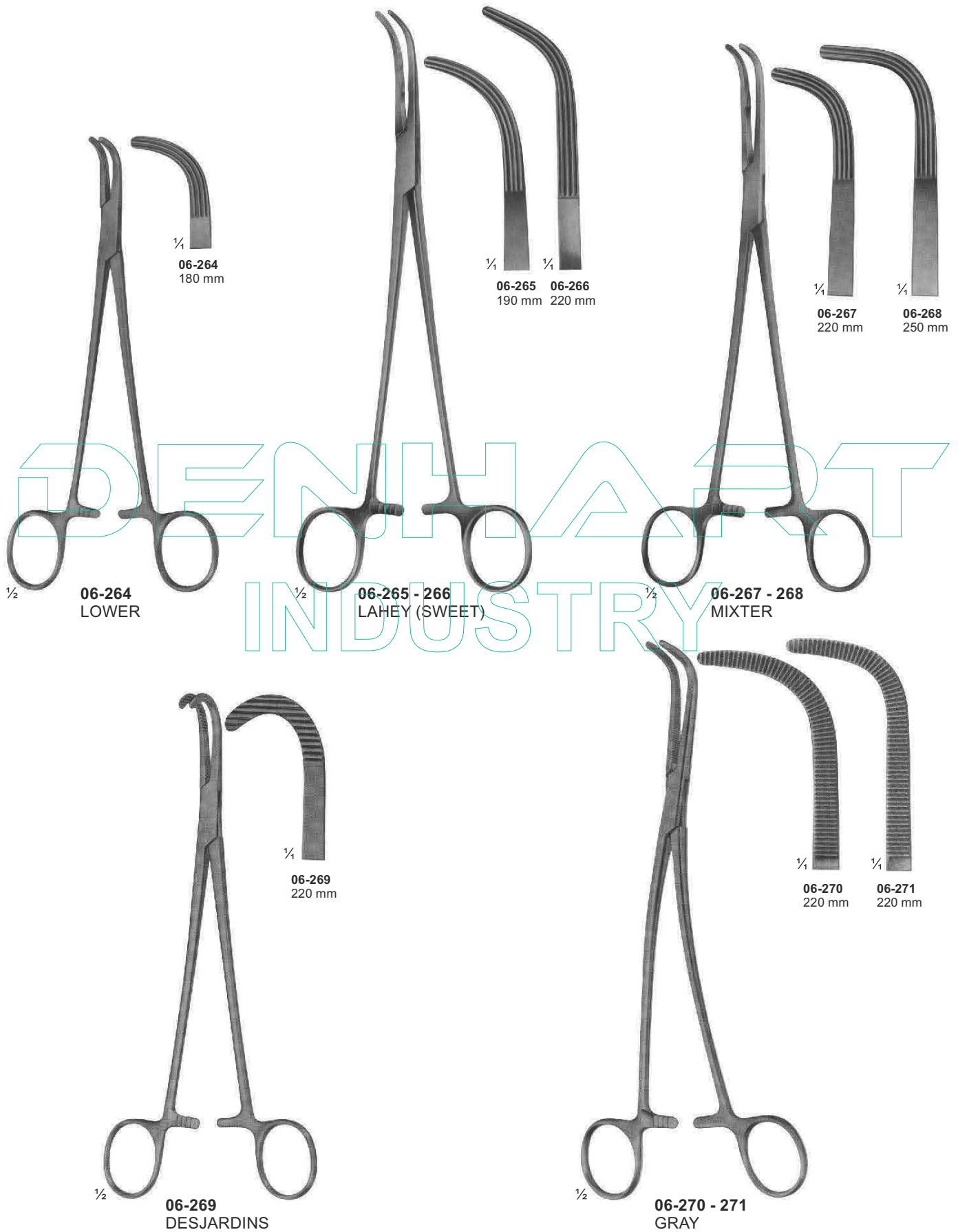

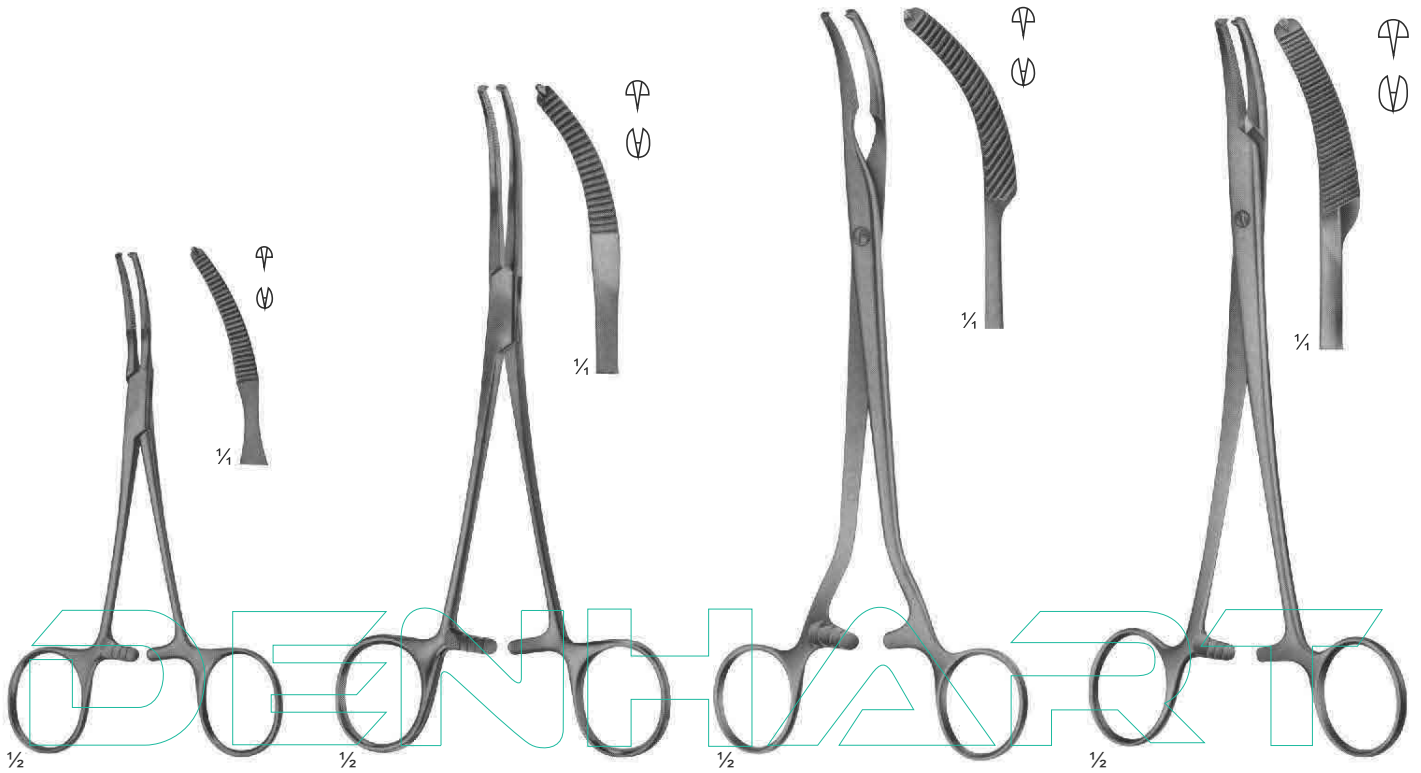

06-272
BABY-MIKULICZ
140 mm

06-273
MIKULICZ
185 mm

06-274
MIKULICZ
205 mm

06-275
MIKULICZ
200 mm

INDUSTRY

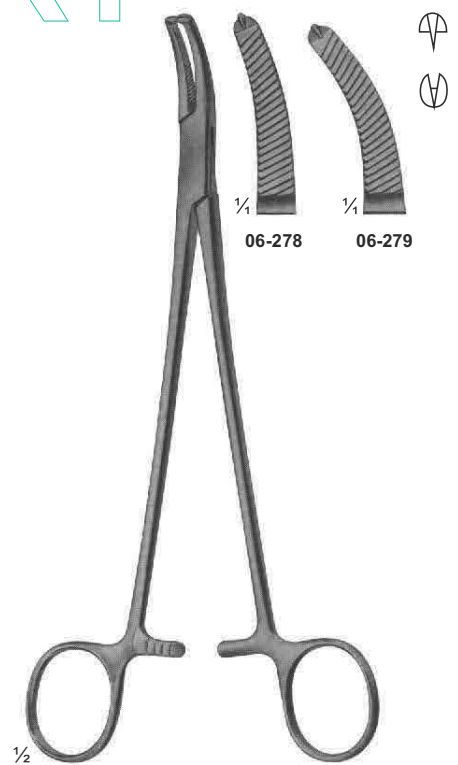
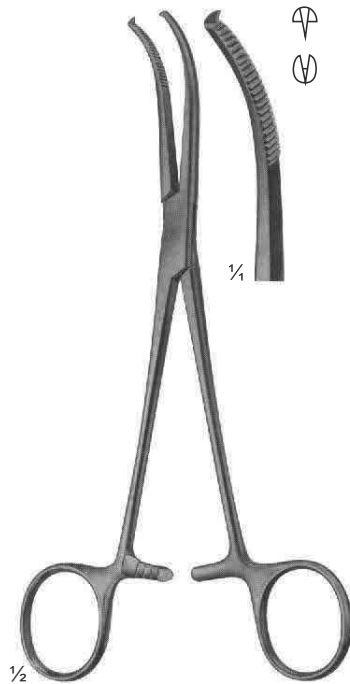
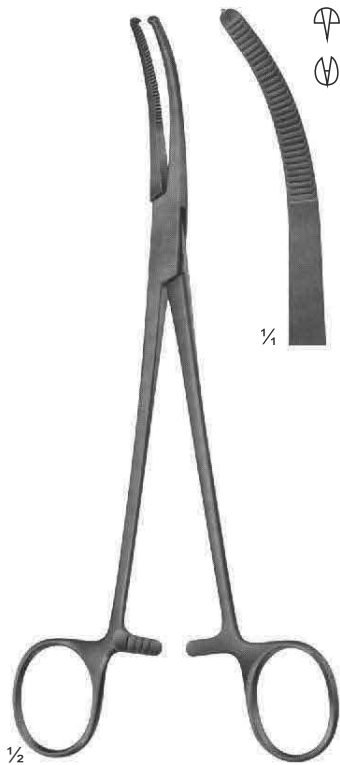

06-276
MIKULICZ
205 mm

06-277
MIKULICZ
185 mm

06-278 - 279
FAURE
205 mm

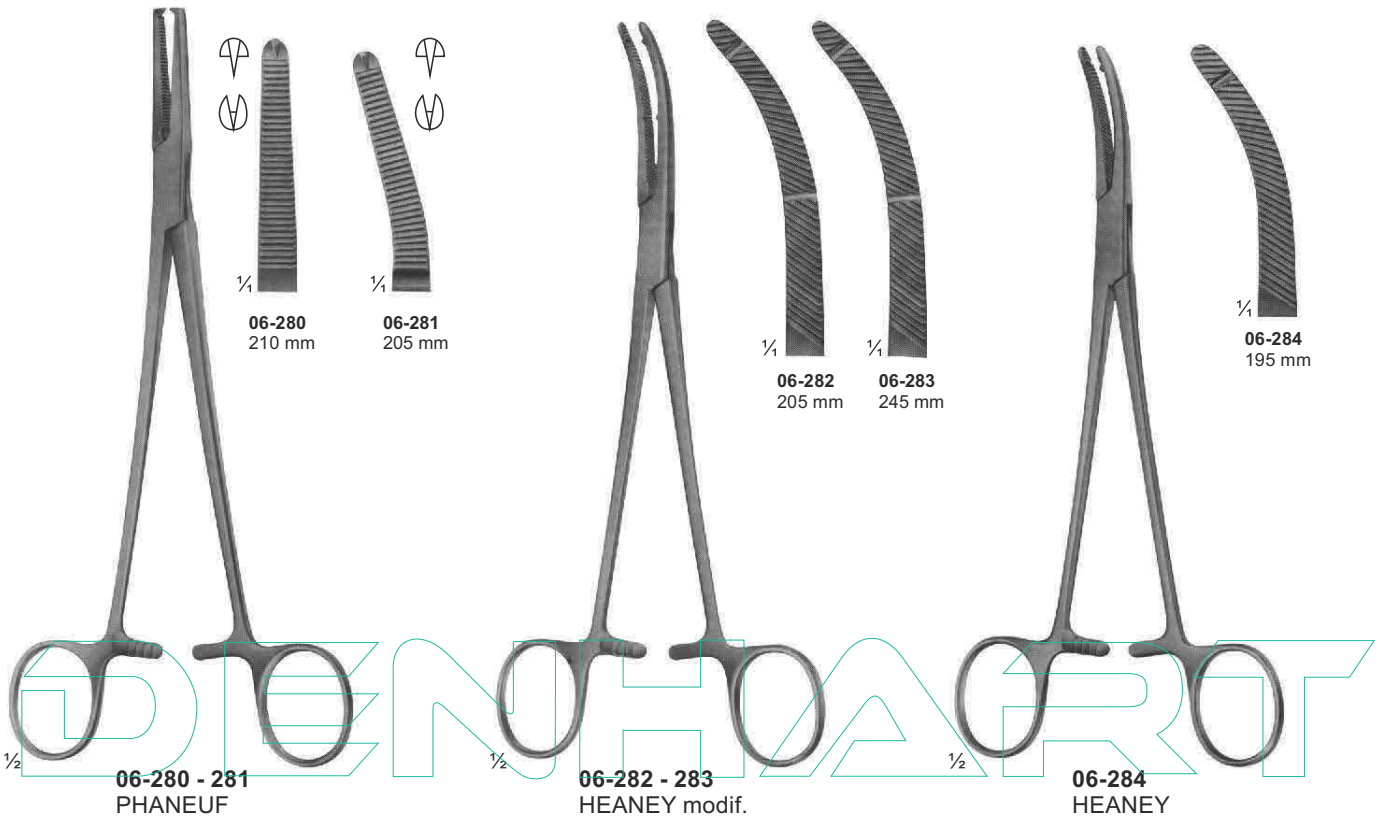

Hysterectomy Forceps and Vaginal Clamps

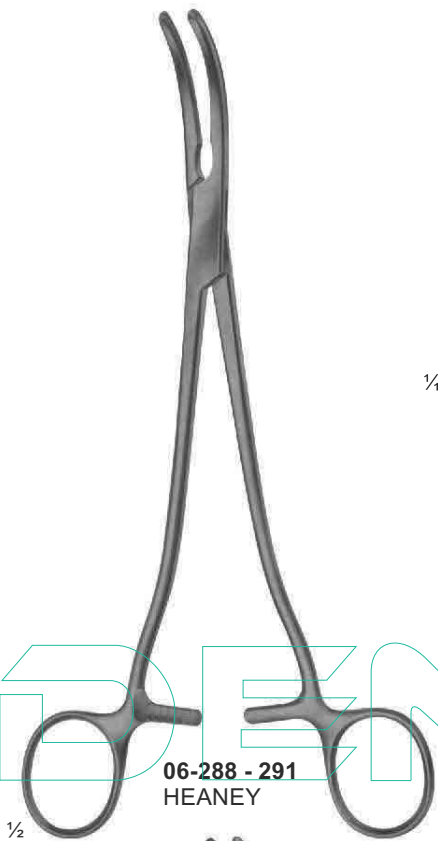

06-288 - 291
HEANEY



06-288
225 mm



06-289
220 mm



06-290
215 mm

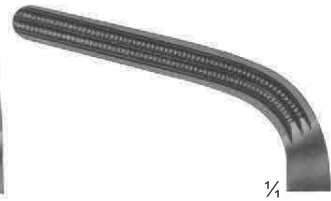

06-291
205 mm



06-292 - 295
WERTHEIM
Parametrium clamps



06-292
250 mm



06-293
245 mm



06-294
240 mm

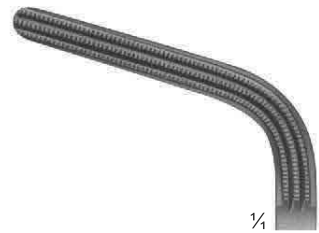

06-295
220 mm

Hysterectomy Forceps and Vaginal Clamps and Compression Forceps

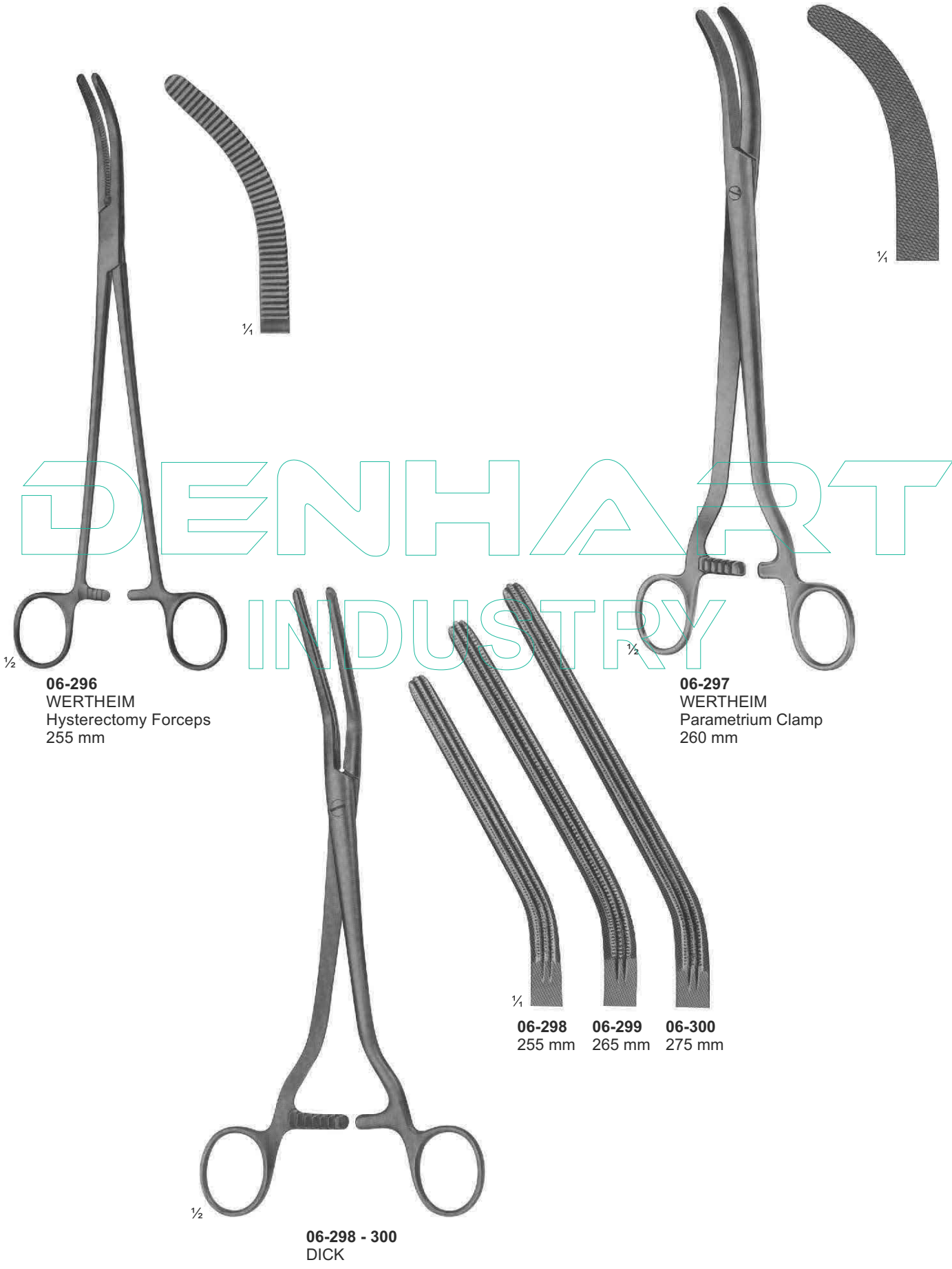

1/2
06-296
 WERTHEIM
 Hysterectomy Forceps
 255 mm

1/2
06-297
 WERTHEIM
 Parametrium Clamp
 260 mm

1/2
06-298 - 300
 DICK

1/4
06-298 255 mm
06-299 265 mm
06-300 275 mm

Hysterectomy Forceps and Vaginal Clamps and Compression Forceps

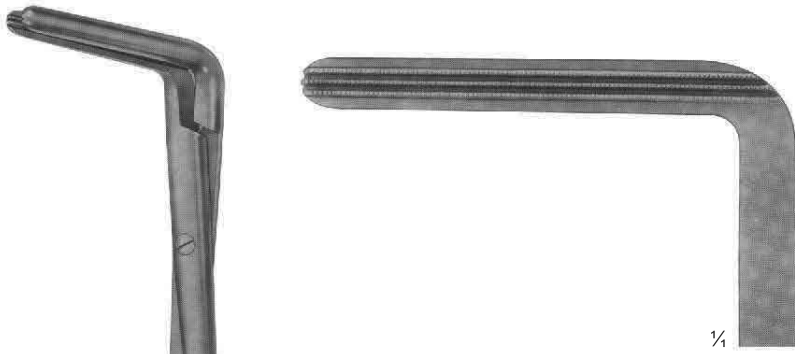

06-301
WERTHEIM
250 mm

1/2

1/4

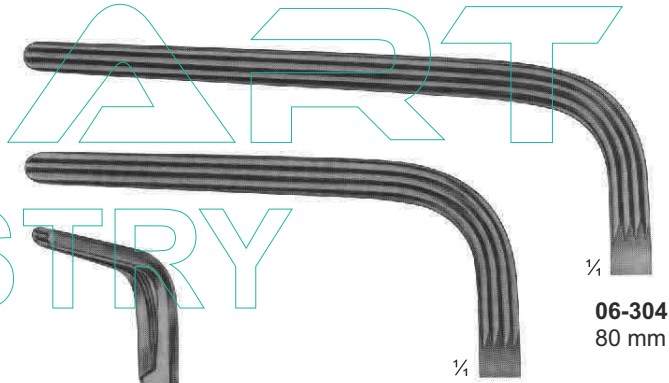

1/4

06-304
80 mm

1/4

06-303
60 mm



1/4

1/2

06-302
WERTHEIM-CULLEN
215 mm



1/2

06-303 - 304
230 mm

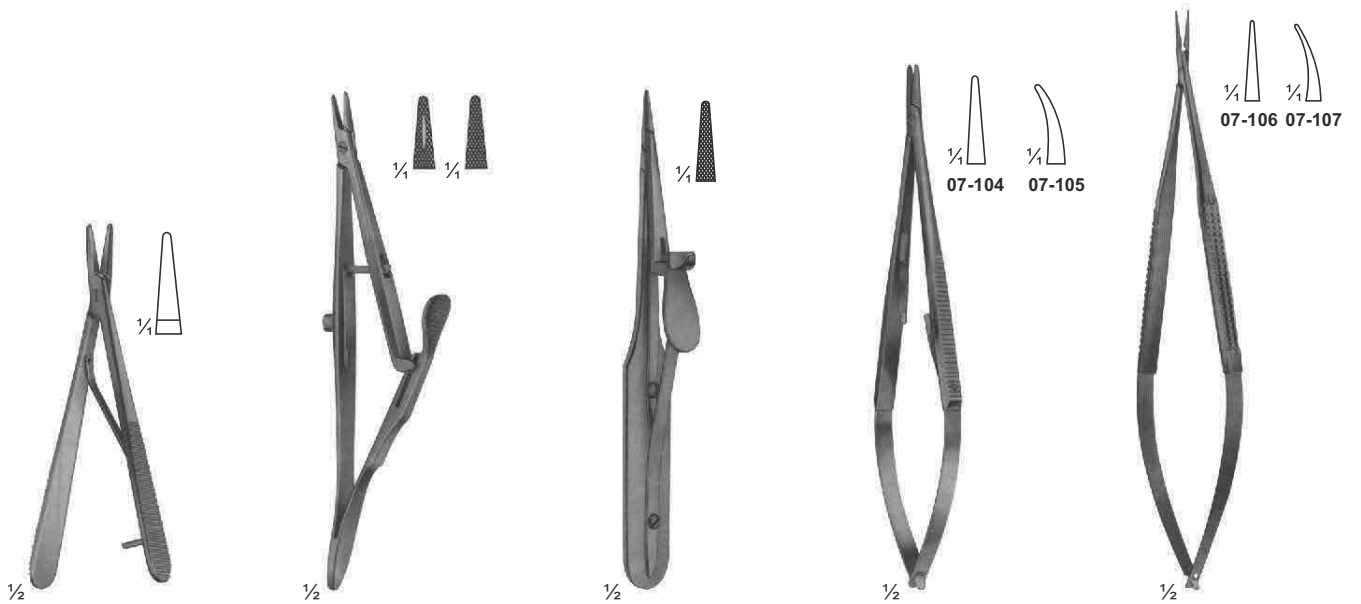

07-101
ROHRSCNEIDER
With copper inserts
100 mm

07-102
KALT
With catch
135 mm

07-103
ARRUGA
With catch
135 mm

07-104 - 105
CASTROVIEJO
With catch
145 mm

07-106 - 107
CASTROVIEJO
With Catch
160 mm

INDUSTRY

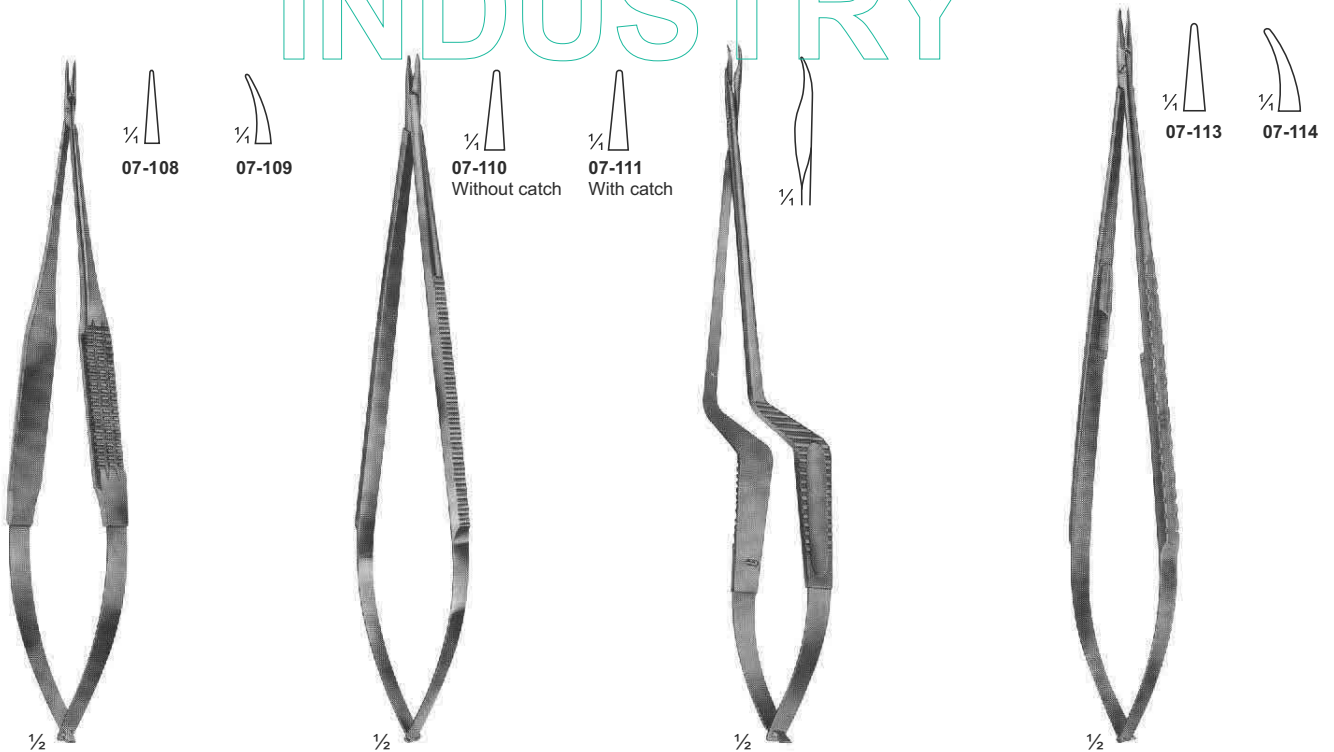

07-108 - 109
Without catch
185 mm



07-110 - 111
JACOBSON
185 mm

07-112
Without catch
195 mm

07-113 - 114
YASARGIL
With catch
200 mm



Micro Needle Holders With Round Handles



 
07-115 **07-116**
 115 mm 135 mm

07-115 - 116
 BARRAQUER
 Without catch



 
07-117 **07-118**

07-117 - 118
 BARRAQUER
 Without catch
 120 mm



 
07-119 **07-120**

07-119 - 120
 BARRAQUER
 With catch
 120 mm



 
07-121 **07-122**

07-121 - 122
 BARRAQUER
 With Catch
 150 mm





07-123
 MULLER
 With Locking
 Mechanism
 145 mm

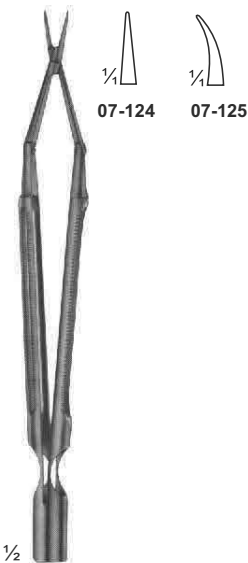

DENHART INDUSTRY



 
07-124 **07-125**



07-124 - 125
 BROCK
 Without catch
 150 mm



 
07-126 **07-127**

07-126 - 127
 YASARGIL
 200 mm



 
07-128 **07-129**

07-128 - 129
 YASARGIL
 225 mm





07-130
 YASARGIL
 245 mm

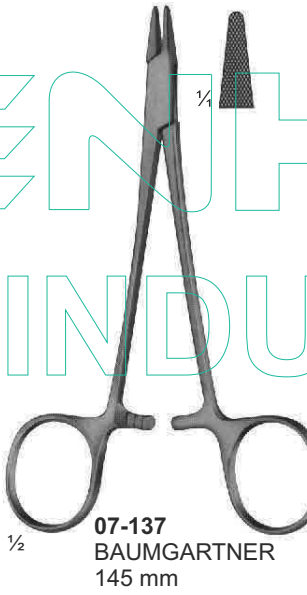
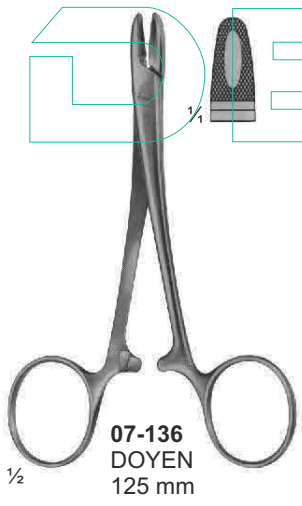
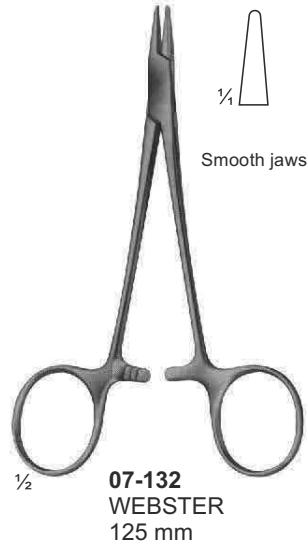

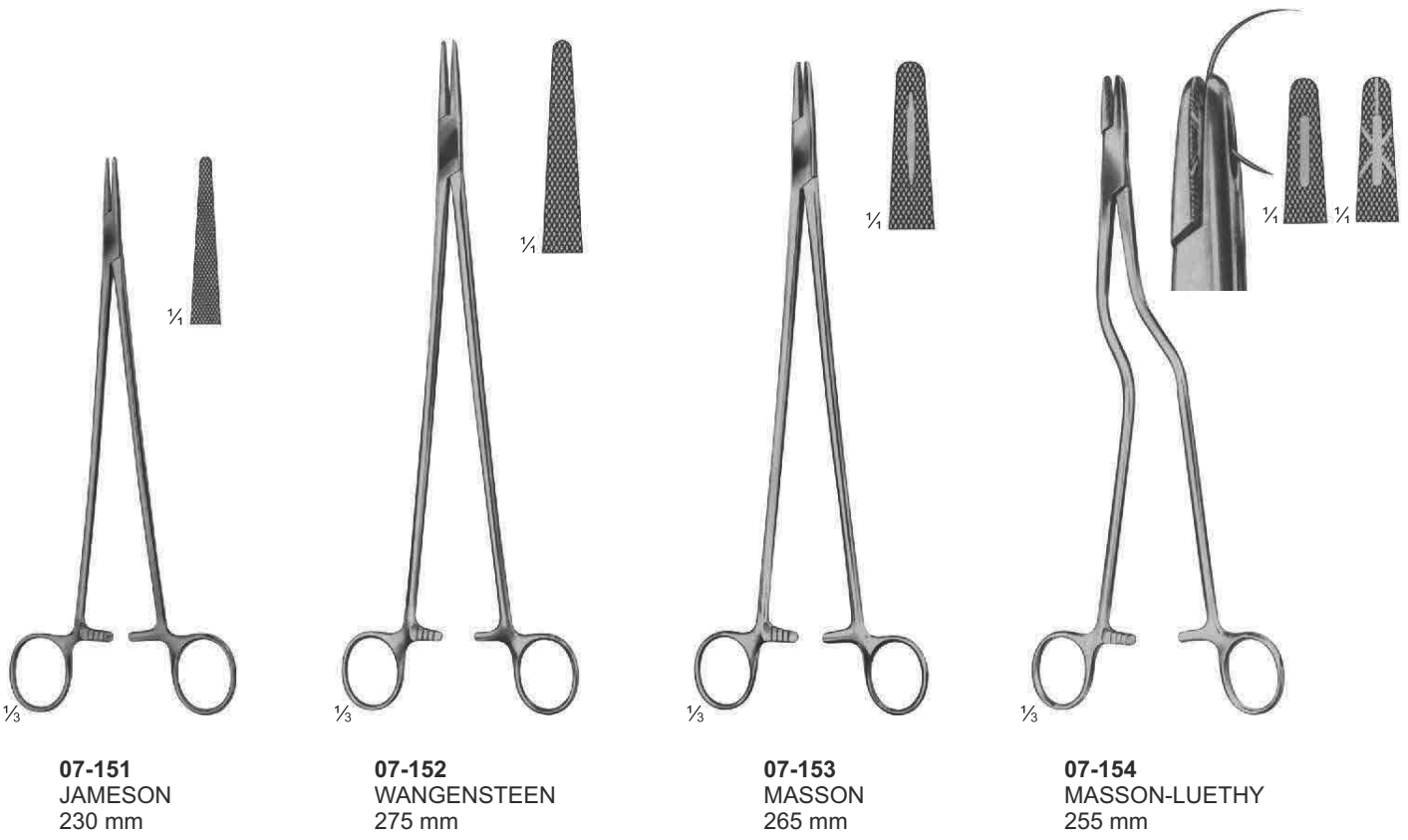

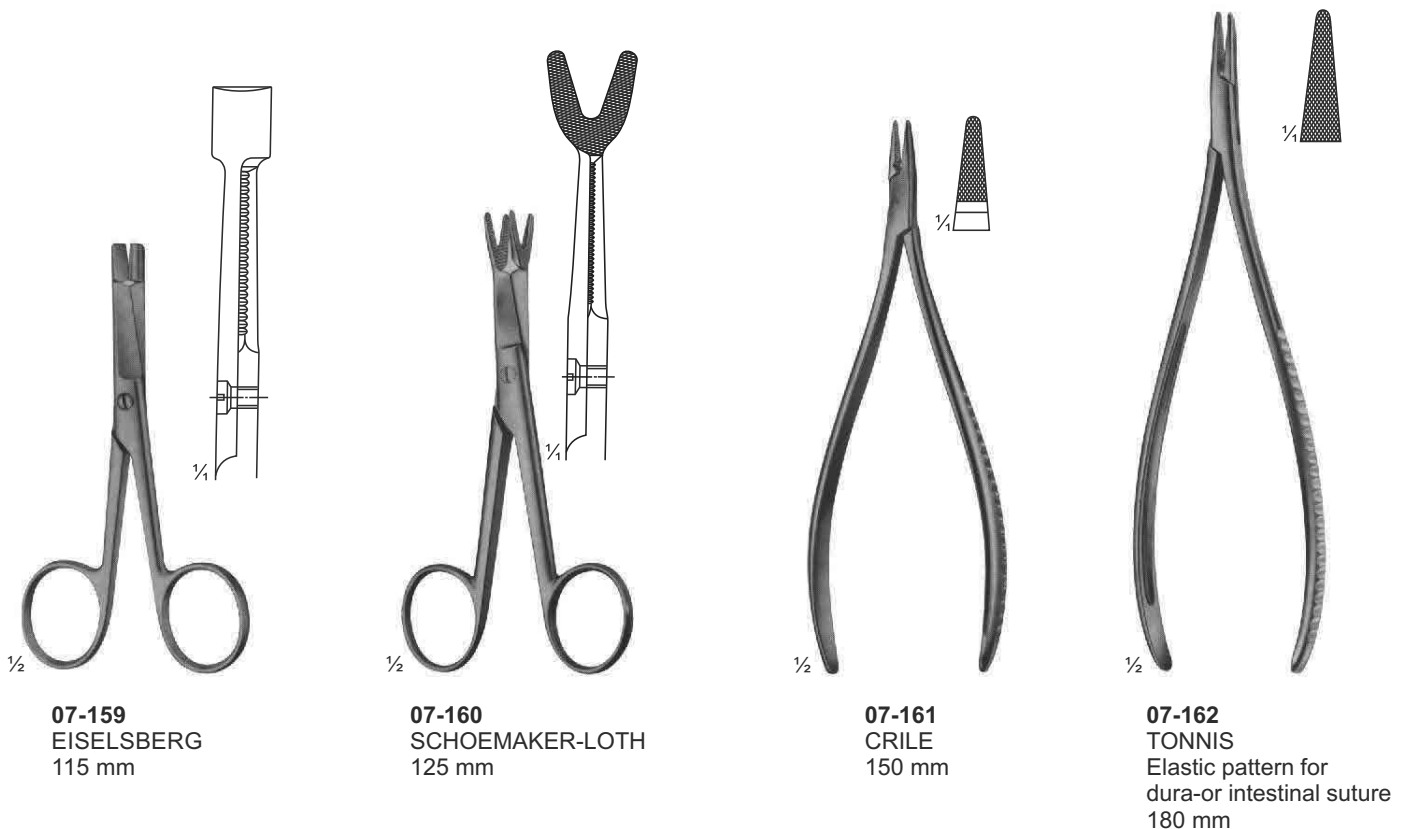
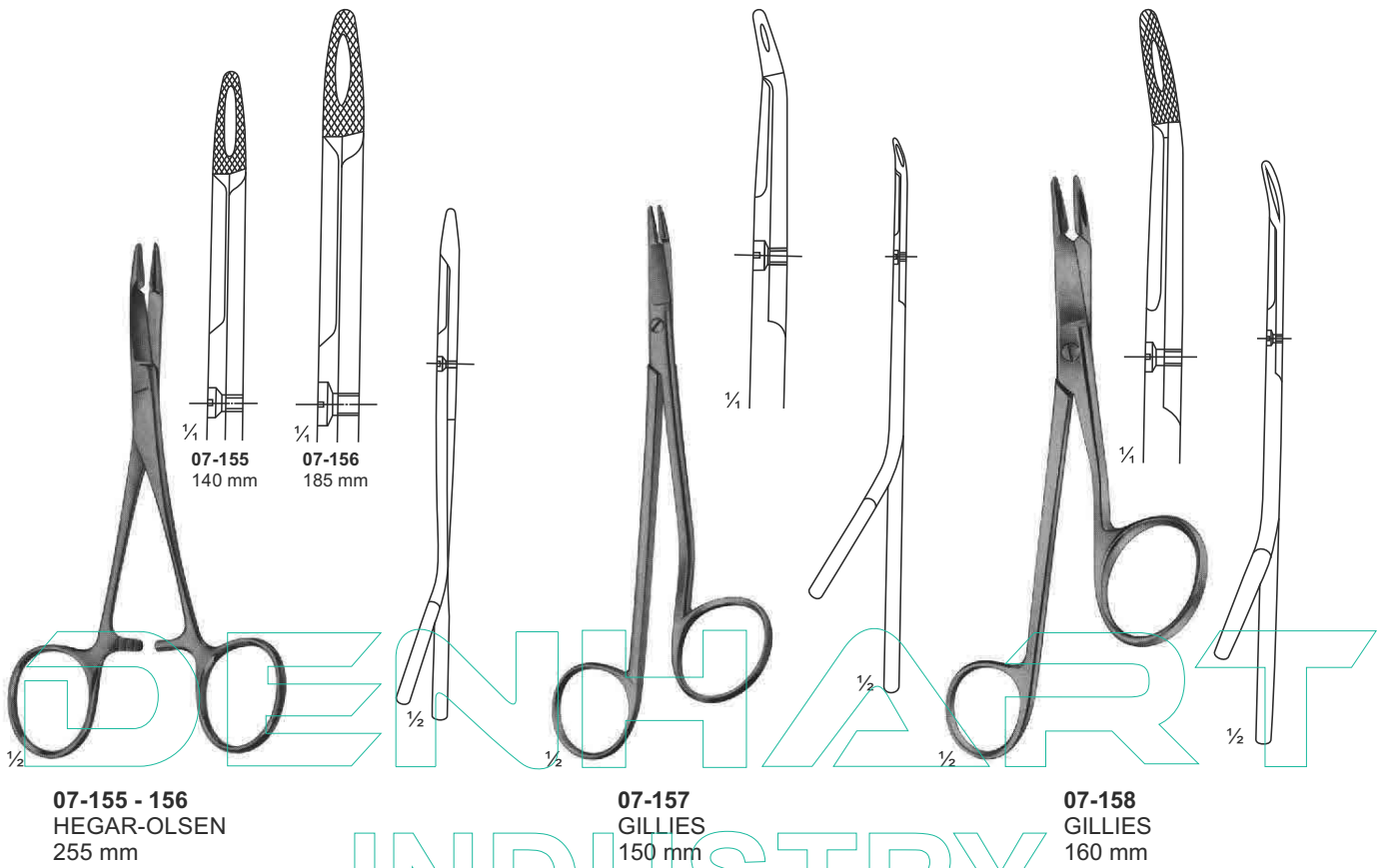

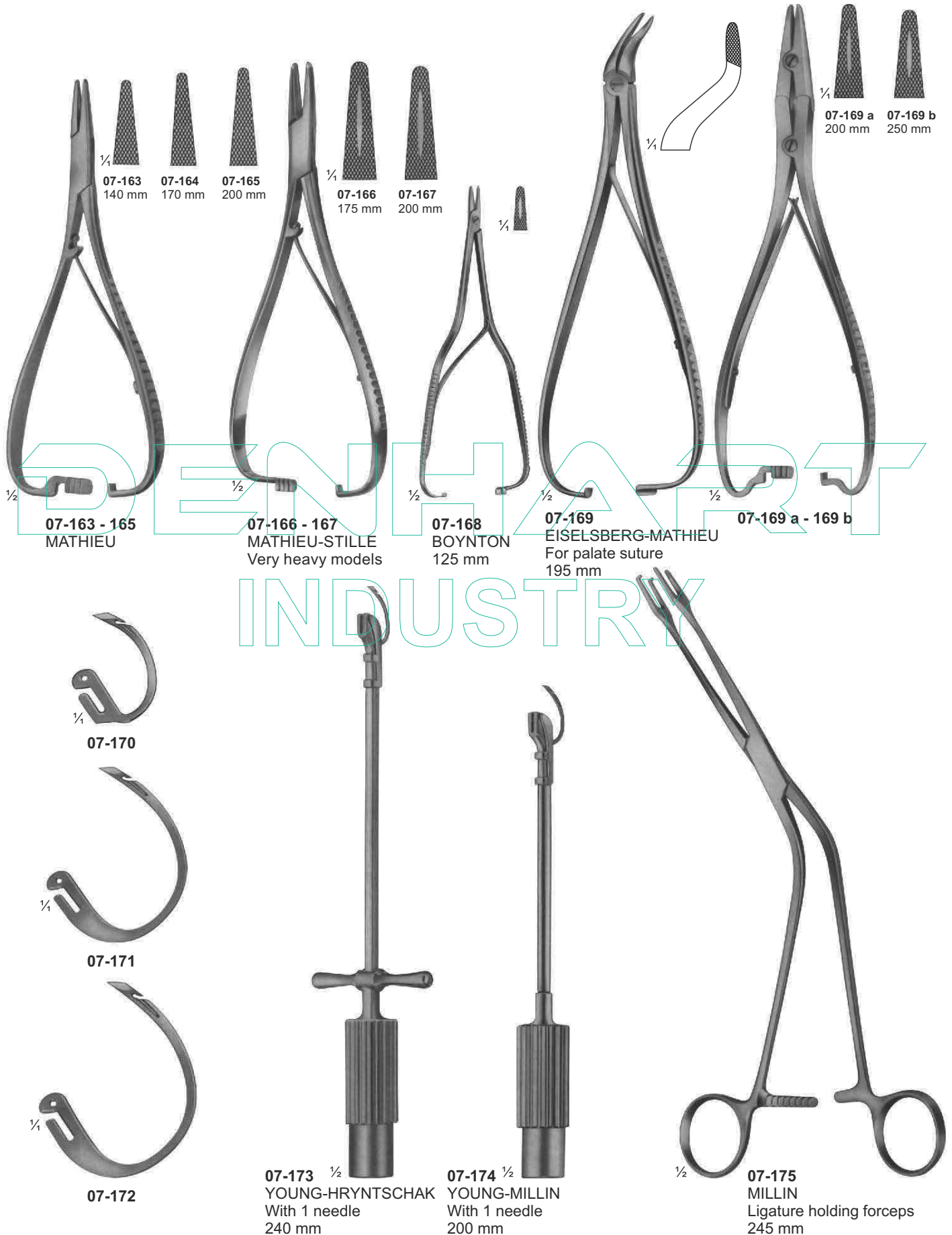

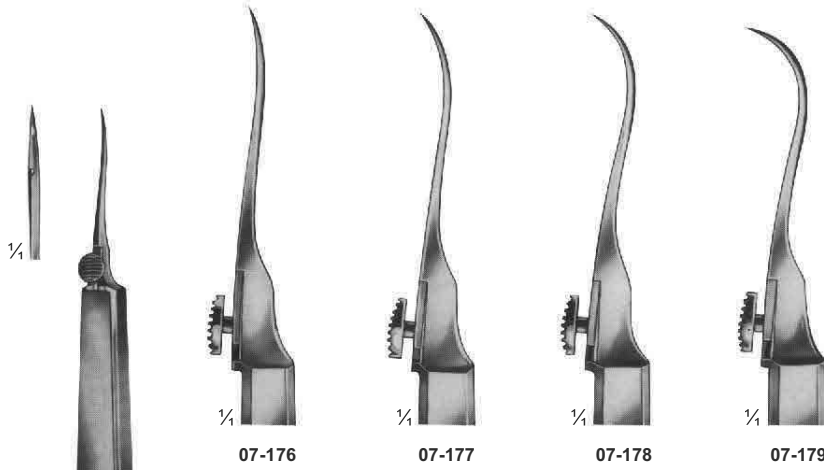

07-176

07-177

07-178

07-179

1/2
07-176 - 179
REVERDIN
140 mm



07-180

07-181

07-182

07-183

07-185

07-186

07-187

07-188

1/2
07-180 - 183
REVERDIN
195 mm

1/2
07-184 - 188
REVERDIN
220 mm

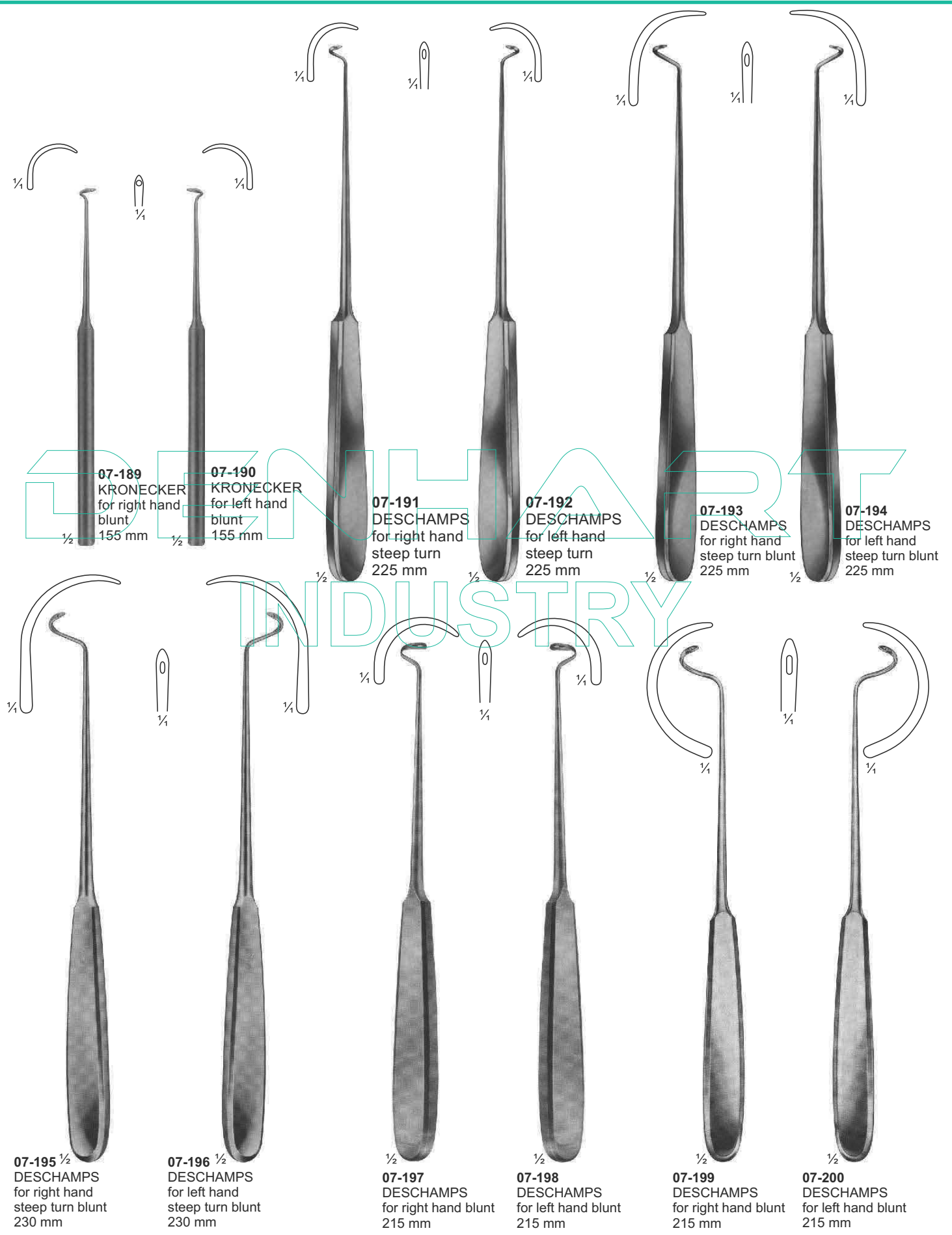

07-189
KRUNECKER
for right hand
blunt
155 mm

07-190
KRUNECKER
for left hand
blunt
155 mm

07-191
DESCHAMPS
for right hand
steep turn
225 mm

07-192
DESCHAMPS
for left hand
steep turn
225 mm

07-193
DESCHAMPS
for right hand
steep turn blunt
225 mm

07-194
DESCHAMPS
for left hand
steep turn blunt
225 mm

07-195 1/2
DESCHAMPS
for right hand
steep turn blunt
230 mm

07-196 1/2
DESCHAMPS
for left hand
steep turn blunt
230 mm

07-197 1/2
DESCHAMPS
for right hand blunt
215 mm

07-198 1/2
DESCHAMPS
for left hand blunt
215 mm

07-199 1/2
DESCHAMPS
for right hand blunt
215 mm

07-200 1/2
DESCHAMPS
for left hand blunt
215 mm



07-201
HURD
for right hand
sharp
210 mm



07-202
HURD
for left hand
sharp
210 mm



07-203
DESCHAMPS
for right hand
sharp
215 mm



07-204
DESCHAMPS
for left hand
sharp
215 mm



07-205
JONESCO
Needle for wire suture
185 mm



07-206
CLAUS VAN EICKEN
Needle for wire suture
250 mm

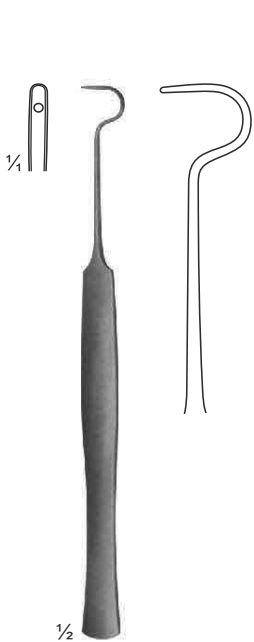

07-207
150 mm

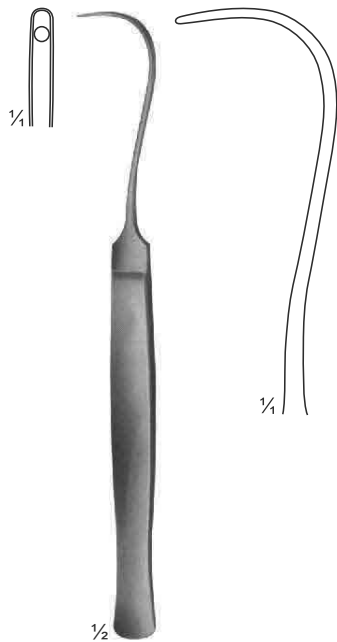

07-208
SYME
170 mm

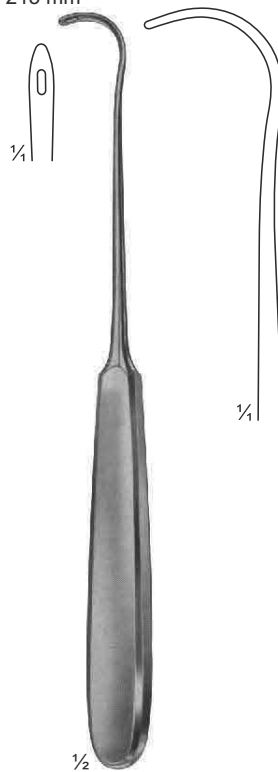

07-209
COOPER
205 mm

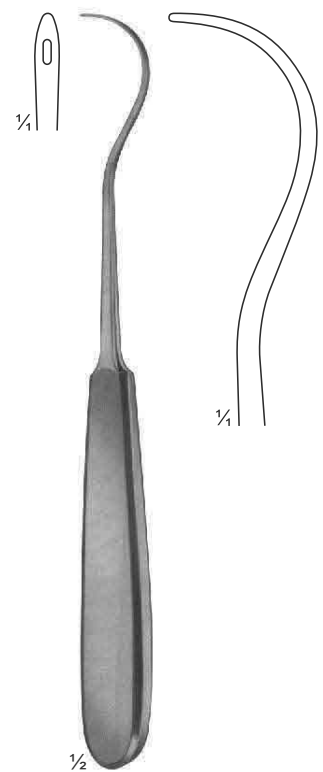

07-210
KOCHER
205 mm

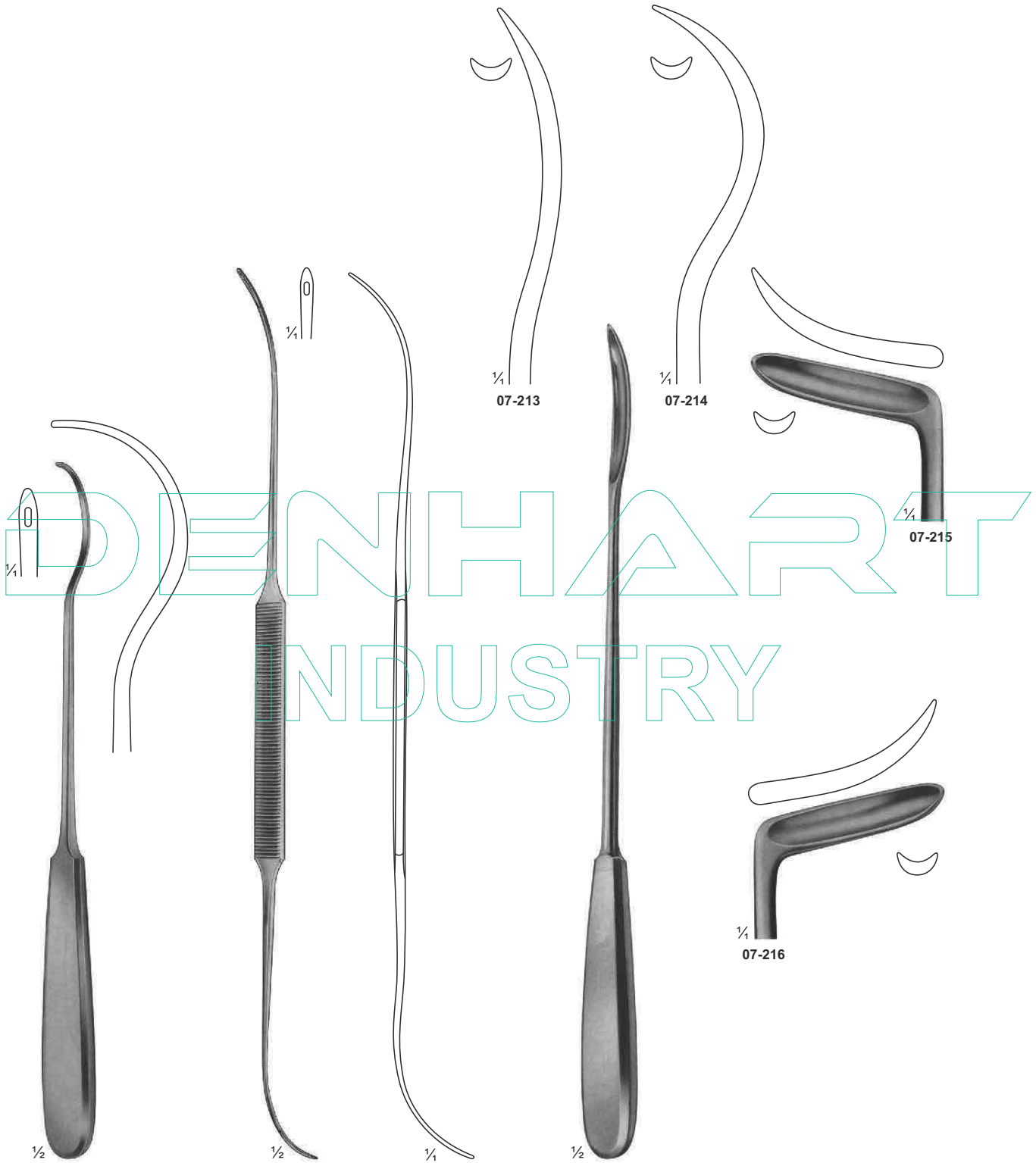

07-211
BRUNNER
240 mm

07-212
SCHMIEDEN-DICK
320 mm

07-213 - 216
BRUNNER
Guiding Probes
300 mm

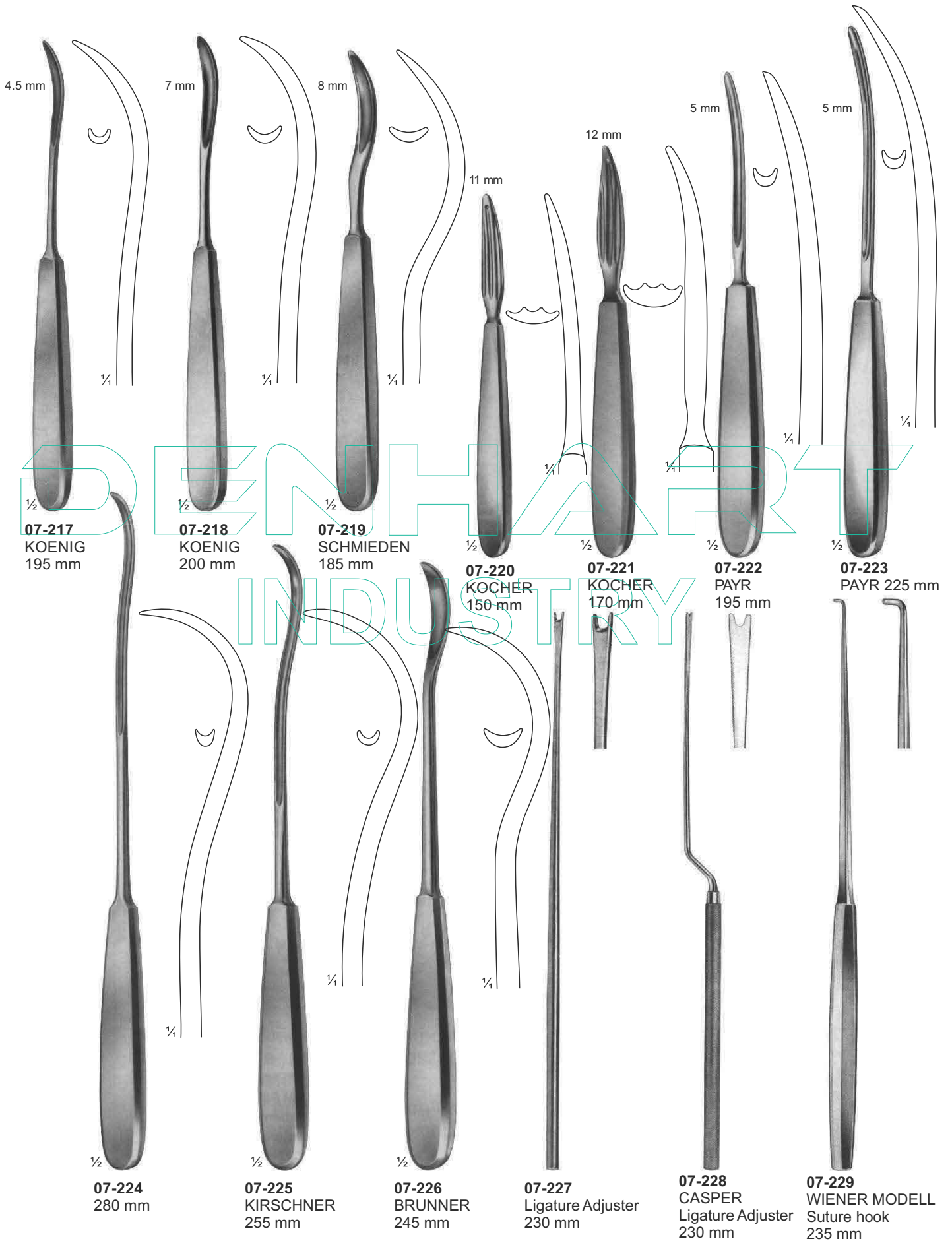

07-242
2,5 mm
07-243
2,5 mm
07-244
3,0 mm

1,5 mm

2,0 mm

1/2

07-242 145 mm
07-243 160 mm
07-244 200 mm
Probes with eye

07-245
Myrtle leaf probe
145 mm

07-246 130 mm
07-247 145 mm
07-248 160 mm
07-249 180 mm
07-250 200 mm

1/2

07-251
Probes

INDUSTRY

07-252 1/2

Double ended probe,
malleable, diam. of tips
3 mm with hole
190 mm

07-253

Double ended probes,
tin, malleable,
diam. of tips
3,5 mm with hole
250 mm, 300 mm

07-254 1/4

Double ended probes,
tin, malleable,
diam. of tips 4 mm
400 mm

1/3 Ø tip

07-255 1,5 mm
07-256 2,0 mm
07-257 2,5 mm
300 mm

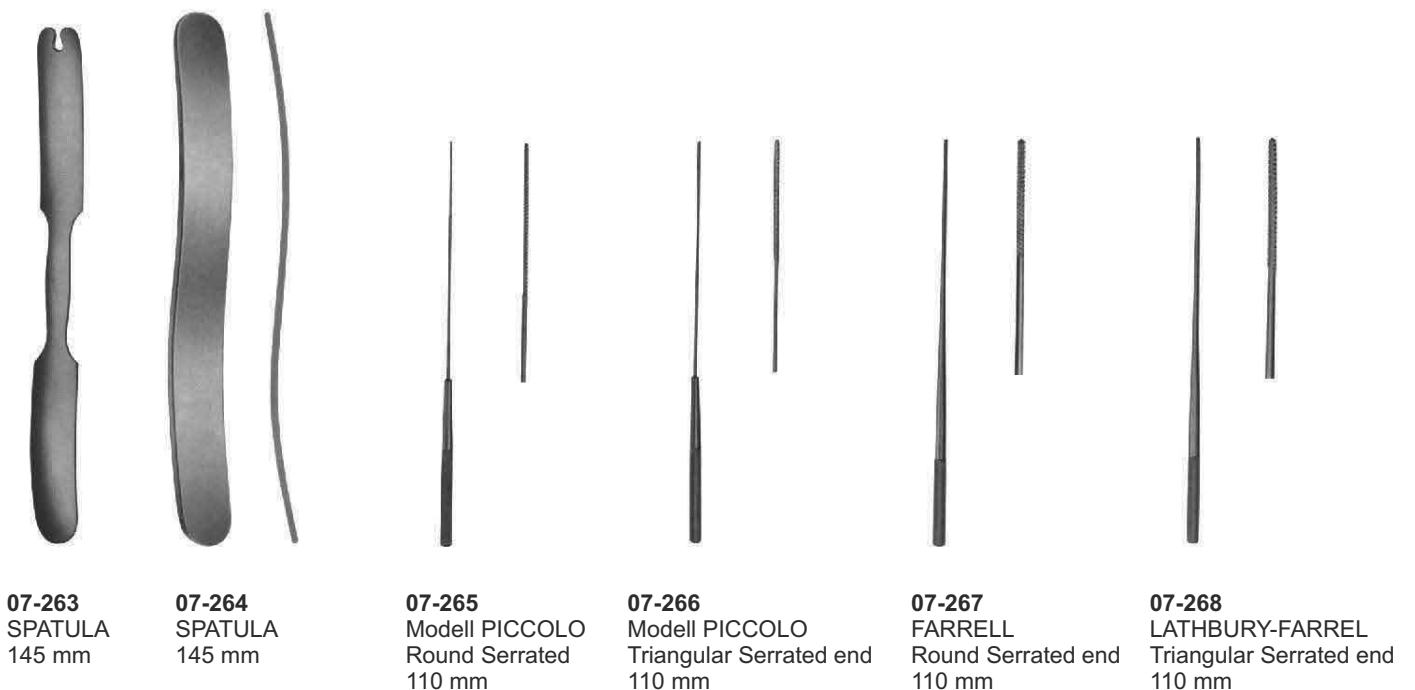
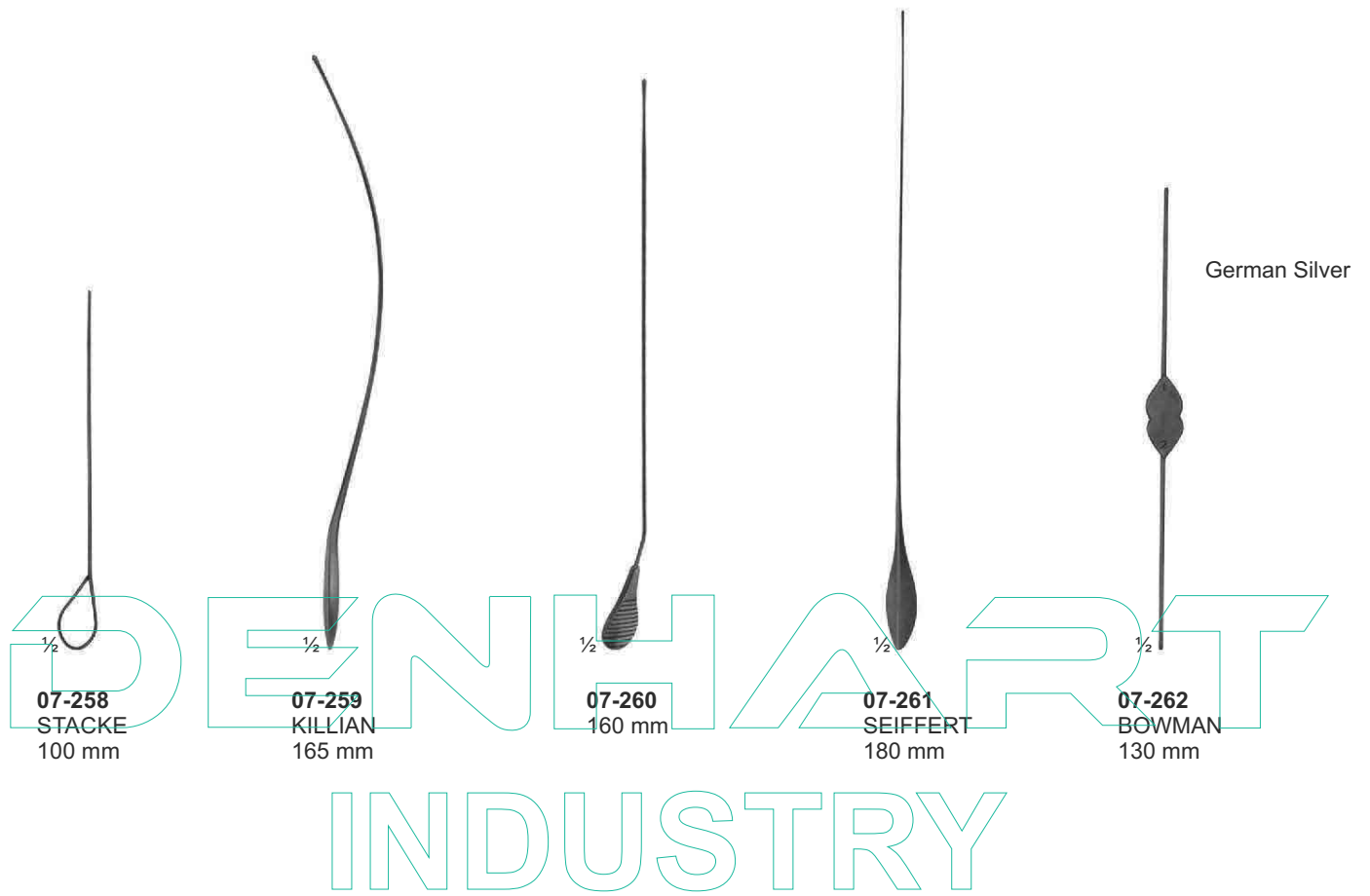



07-269
BUCK
Rough, spiral end
120 mm

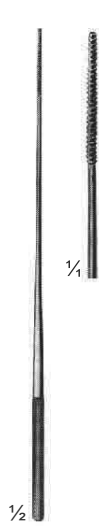

07-270
Triangular
serrated end
140 mm



07-271
Rough, spiral end
140 mm



07-272
Rough, spiral end
140 mm



07-273
Rough, spiral end
140 mm



07-274
FARRELL
Round,
serrated end
140 mm



07-275
LATHBURY-FARRELL
Triangular,
serrated end
140 mm

DENHART
INDUSTRY



07-276
FARRELL
Rough,
spiral end
160 mm



07-277
LATHBURY-FARRELL
Triangular,
serrated end
160 mm



07-278
Triangular,
serrated end
160 mm



07-279
Rough,
spiral end
180 mm



07-280
Rough,
spiral end
180 mm



07-281
Rough,
spiral end
270 mm



07-282
MICHEL
125 mm



07-283
HEGENBARTH
120 mm



07-284
WACHENFELDT
120 mm



07-285
WACHENFELDT
120 mm

DENHART
INDUSTRY



07-286
MICHEL
125 mm



07-287
MICHEL modif.
130 mm



07-288
HEATH
135 mm

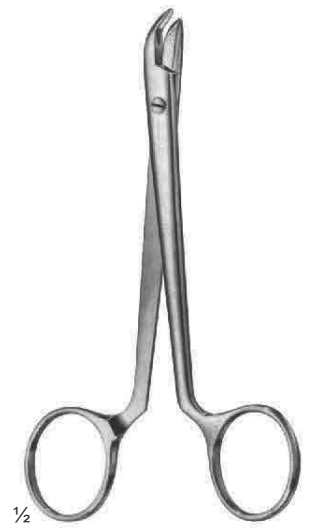

07-289
COLLIN
135 mm



07-290

Suturing instruments set, in metal case consisting of: Scissors, curved, sharp/sharp, 115mm
25 MICHEL clip, 16 x 3mm
1 Delicate tissue forceps, 130mm
1 Scalpel, bellied
1 MATHIEU needle holder, 140mm
1 Perforated metal case, stainless containing:
1 Suture needle
1 item 1 item



07-291

Pocket instrument set, in metal case consisting of:

Bottom tray

1 MATHIEU needle holder, 140mm
1 MICHEL clip forceps, combined
1 Myrtle leaf probe, 130mm
1 Sharp double curette
1 Skin hook
1 Detachable scalpel handle, no.4
1 Perforated metal case, containing
6 Scalpel blades BB 520
1 Perforated metal case, stainless, containing
1 Suture needle
1 item
1 item

Top tray

1 Tissue forceps, 130mm
1 KOCHER haemostatic forceps, 130mm
1 Straight surgical scissors, 130mm
1 Dissecting forceps, 130mm
1 FEILCHENFELD splinter forceps, 115mm
25 MICHEL clip, 16 x 3mm
1 Flacon of suture skin, sterile in alcohol



07-292

Pocket instrument set, in metal case consisting of:

Bottom tray

1 MAYO-HÉGER needle holder, 150mm
1 MICHEL clip forceps, combined
1 Myrtle leaf probe, 130mm
1 Sharp double curette
1 Skin hook
1 Detachable scalpel handle, no. 4
1 Perforated metal case, consisting
6 Scalpel blades BB 520
1 Perforated metal case, stainless, consisting:
1 Suture needle
1 item, & 1 item

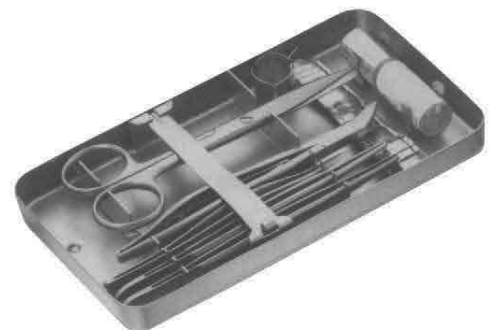

Bottom tray

1 Tissue forceps, 130mm
1 CRILE haemostatic forceps, 140mm
1 Straight surgical scissors, 130mm
1 Dissecting forceps, 130mm
1 FEILCHENFELD splinter forceps, 115mm
25 MICHEL clip, 16 x 3mm
1 Flacon of suture silk, sterile in alcohol

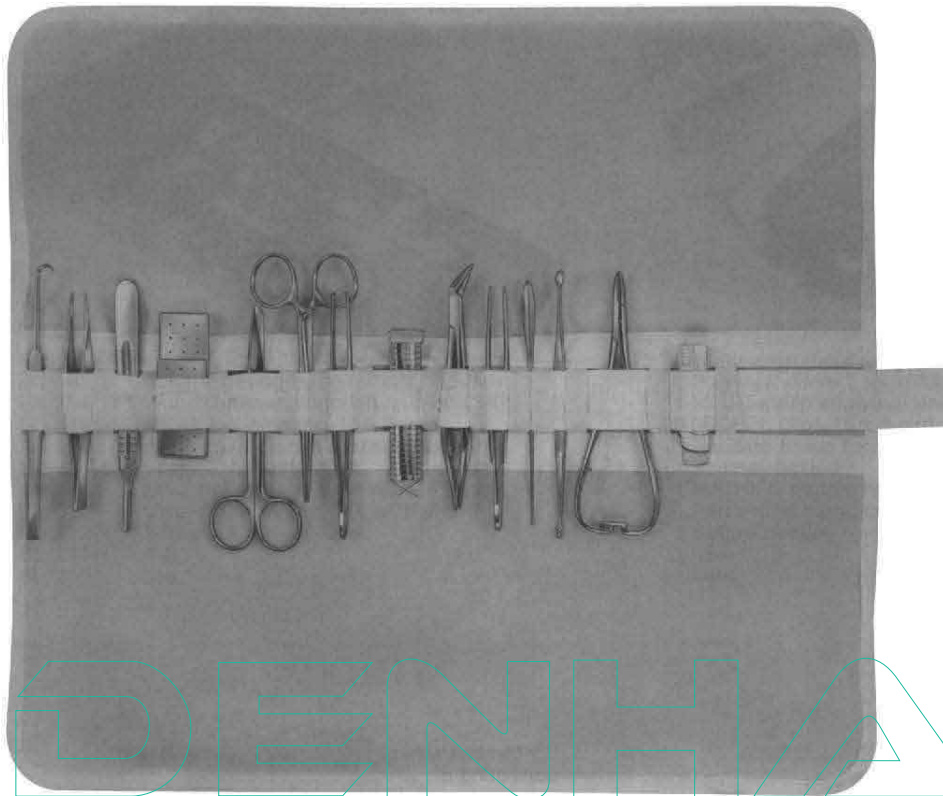

07-293

Pocket instrument set in metal case 170 x 90mm with sterilizable canvas roll consisting of:

- 1 Myrtle leaf probe, 130mm
- 1 Sharp double curette
- 1 FEILCHENFELD splinter forceps, 115mm
- 1 Dissecting forceps, 130mm
- 1 Tissue forceps, 130mm

- 1 Straight surgical scissors, 130mm
- 1 Scalpel handle no. 4
- 1 Perforated metal case, consisting
- 6 scalpel blades BB 520
- 1 KOCHER haemostatic forceps, 130mm
- 1 Skin hook
- 1 MATHIEU needle holder, 140mm
- 1 Tube of suture skin, sterile in alcohol
- 1 MICHEL clip forceps, 120mm

- 25 MICHEL clip, 16 x 3mm
- 1 Perforated metal case, stainless, consisting:
- 1 Suture needle
- 1 item
- 1 item

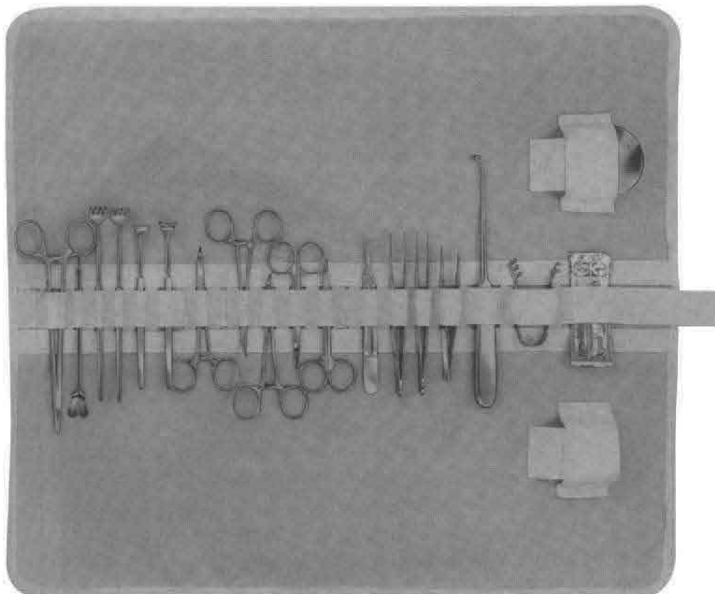

07-294

Venae sectio set, in sterilizable canvas roll consisting of:

- 1 Tissue forceps, 1 x 2 teeth, 140mm
- 1 Dissecting forceps, 145mm
- 1 FEILCHENFELD straight scissors, sharp, 110mm
- 1 curved scissors, blunt, 115mm
- 1 HALSTED mosquito forceps, curved on flat, 125mm

- 1 DESCAMPS needle, blunt, 210mm
- 1 DOYEN Director, curved, 140mm
- 2 Wound retractors, 4 blunt prongs, 160mm
- 2 DESMARRES wound retractors, 135mm
- 1 FINSSEN retractors, 2 x3 blunt prongs, 80mm

- 1 Scalpel handle no. 4
- 4 Sterile scalpel blades, no 18, single peel pack
- 1 Needle box, perforated, round, diam. 65mm
- 1 HEGAR-MAYO DUROGRIP needle holder, 180mm

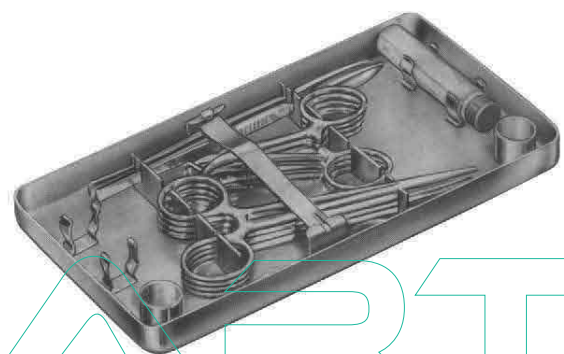
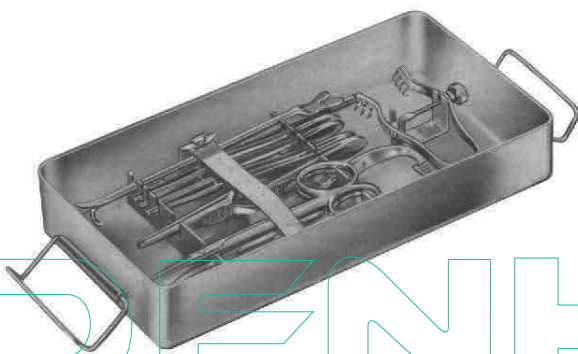

DENHART
INDUSTRY

07-295

Venae sectio set, in metal case
consisting of:

Bottom tray

- 1 MATHIEU needle holder, fine pattern 140mm
- 1 Ligature needle, fine short pattern
- 1 DOYEN director, curved
- 1 HEGENBARTH clip forceps,
- 1 ELSCHNIG tissue forceps, 1 x 2 teeth fine, 150mm
- 1 Dressing forceps, fine 105mm
- 1 Tissue forceps, 1 x 2 teeth, 110mm
- 1 Vessel scissors, straight, with 1 ball point, 110mm
- 1 Vessel scissors, curved, pointed 105mm
- 1 FINSSEN retractor
- 1 Perforated needle case

Top tray

- 1 Scalpel, pointed
- 1 Scalpel, bellied
- 2 HALSTED mosquito forceps, curved, 125mm
- 2 HALSTED mosquito forceps, straight, 1x 2 teeth, 125mm
- 3 BACKHAUS towel forceps, 90mm
- 2 Flacon holder

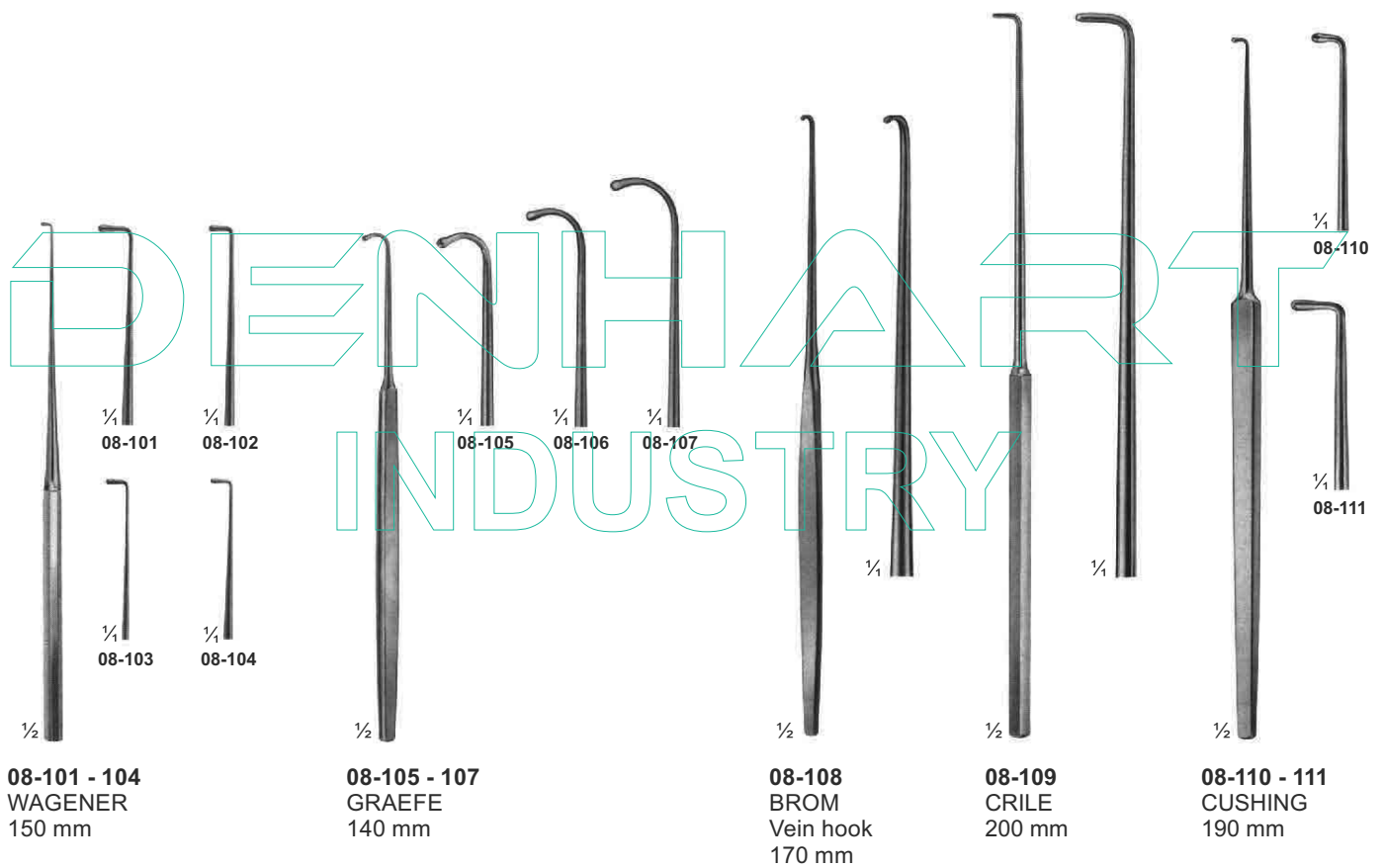



Fine Wound Retractors (Dura- and Skin Retractors)

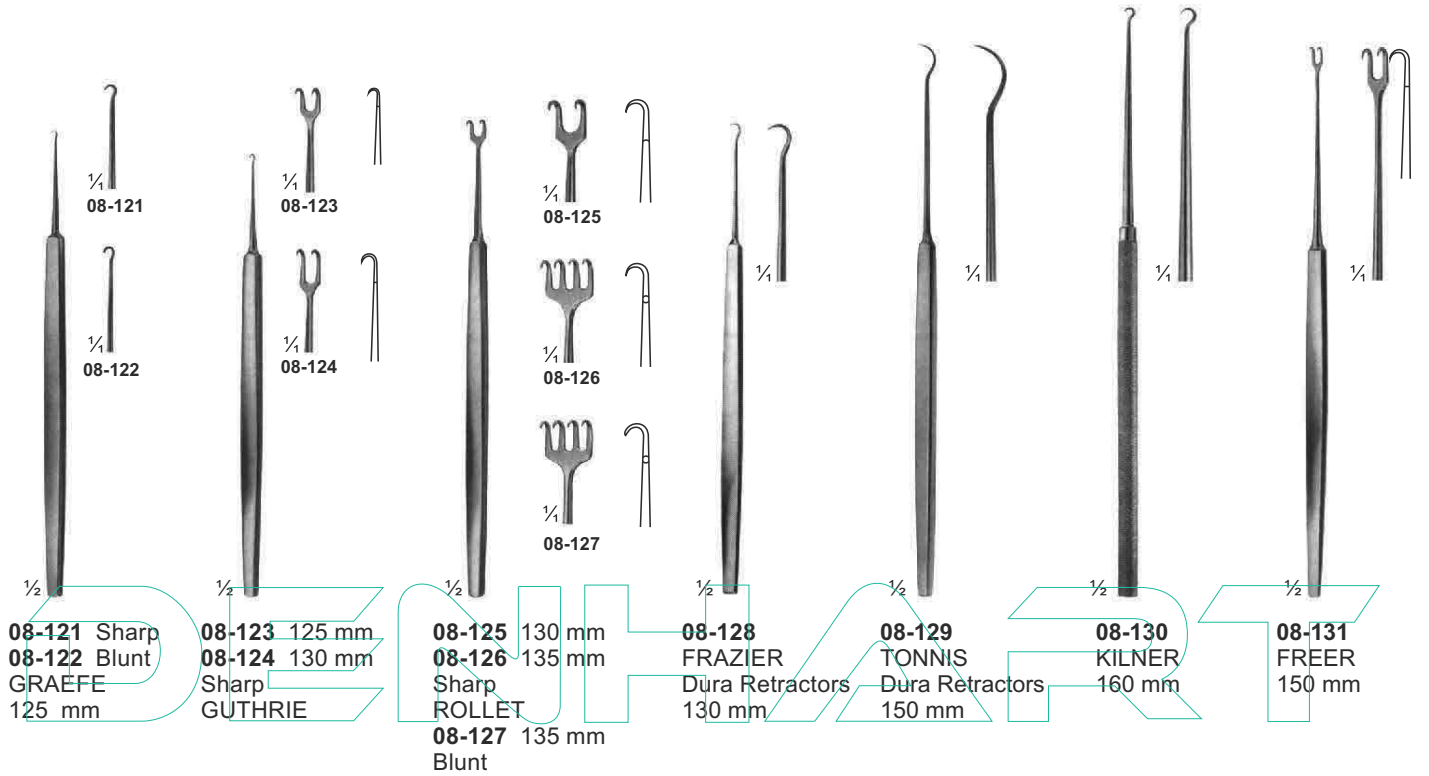

INDUSTRY

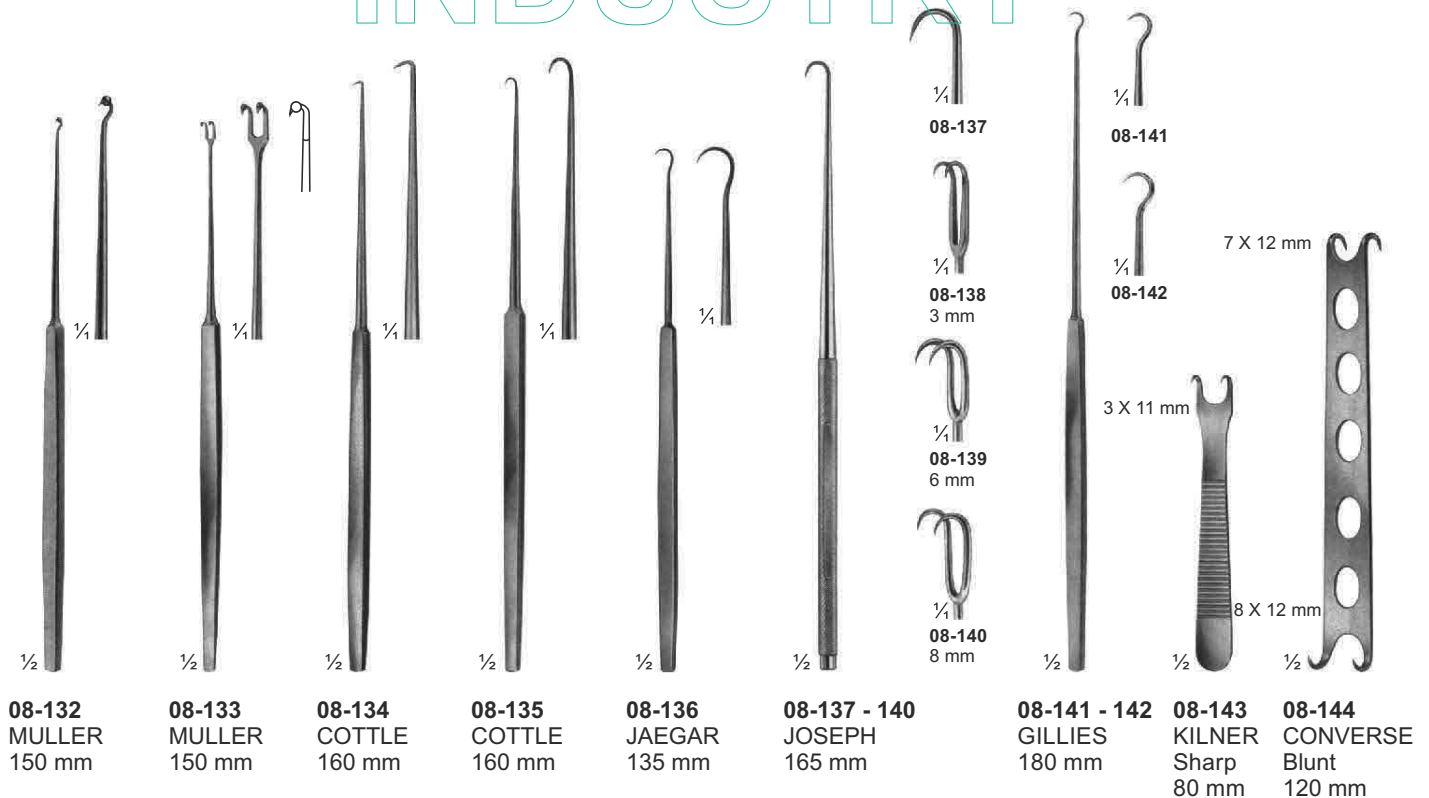

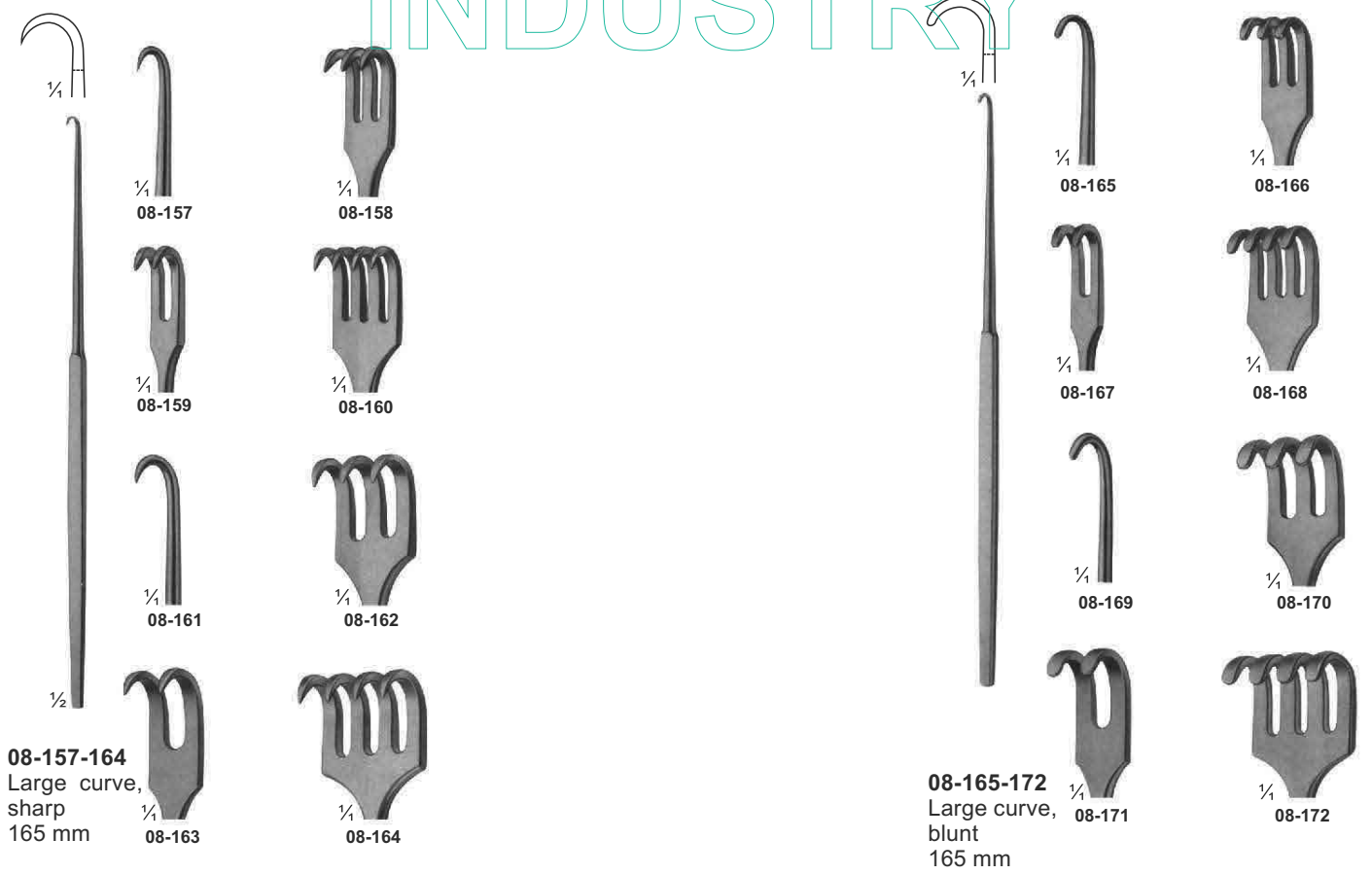
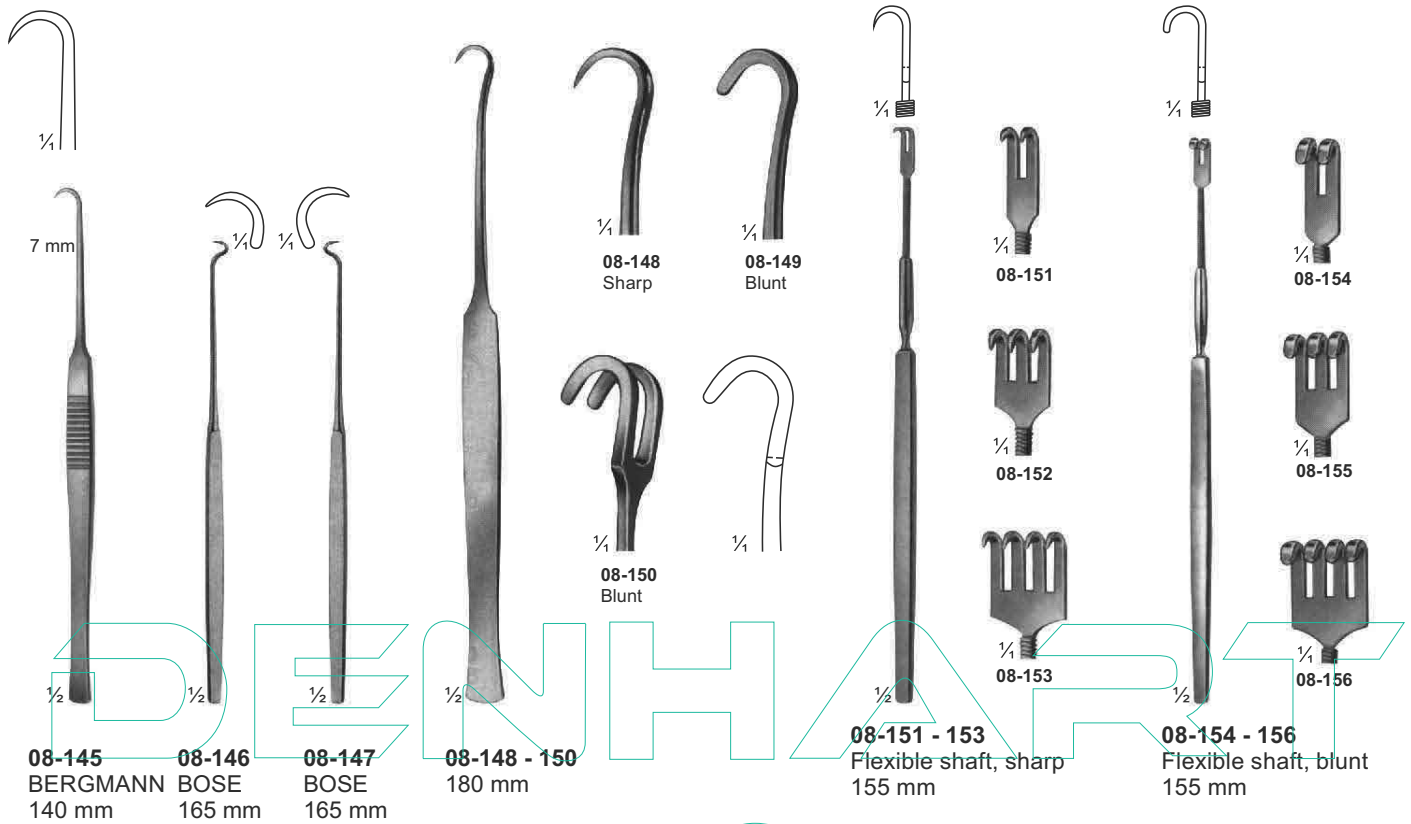

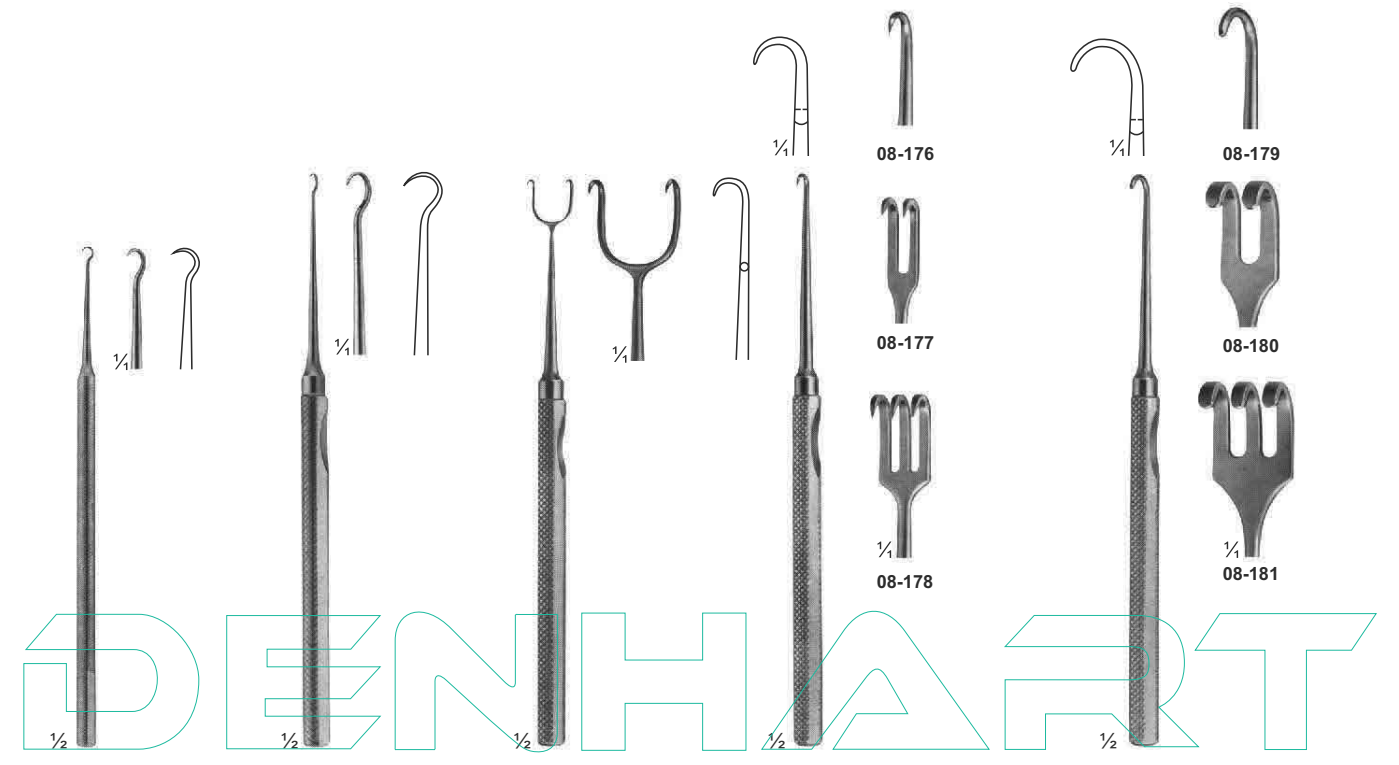

08-173
MANNERFELT modif.
sharp
135 mm

08-174
MANNERFELT modif.
sharp
155 mm

08-175
MANNERFELT modif.
sharp
155 mm

08-176 - 178
MANNERFELT modif.
Small curve, sharp
155 mm

08-179 - 181
MANNERFELT modif.
Large curve, blunt
155 mm

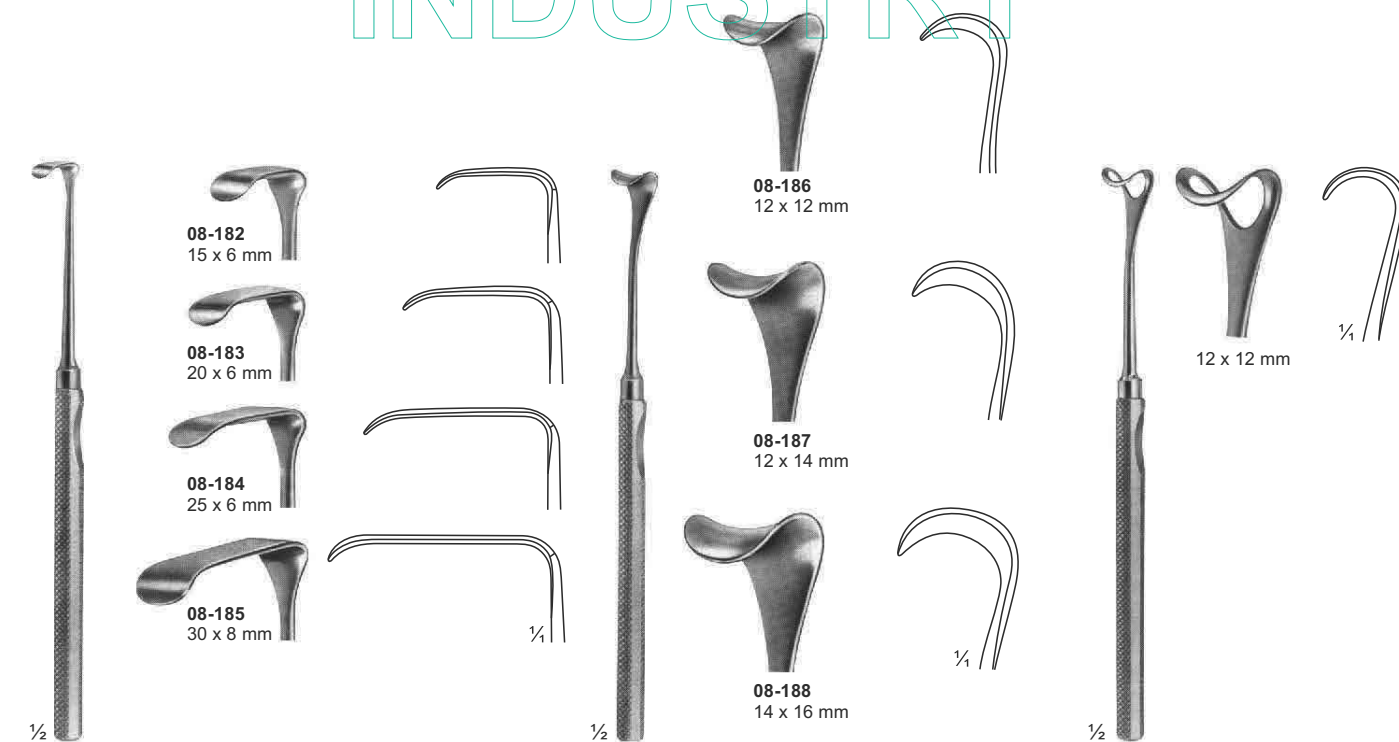

08-182 - 185
LANGENBECK-
MANNERFELT modif.
155 mm

08-186 - 188
MANNERFELT modif.
Saddle hooks,
155 mm

08-189
MANNERFELT modif.
Saddle hooks, fenestrated
155 mm

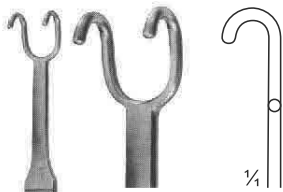

08-190
FOMON
145 mm



08-191 - 192
160 mm



08-193
16 x 6 mm

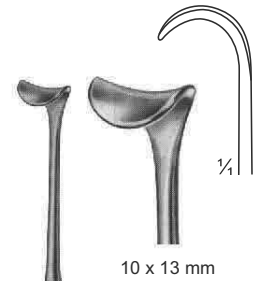

10 x 13 mm



08-192



08-194
24 x 6 mm



08-195
160 mm

DENHART
INDUSTRY



08-196 - 201
MEYERDING
Fig. A - Fig. F
180 mm

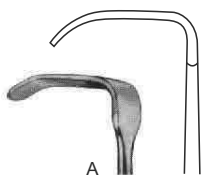

A
08-196
18 x 7 mm

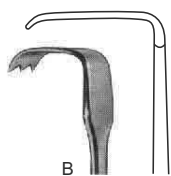

B
08-197
16 x 5 mm

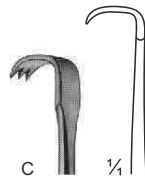

C
08-198
7 x 4 mm



D
08-199
5 x 10 mm



E
08-200
11 x 4 mm



F
08-201
6 x 4 mm

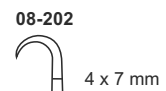

08-202
4 x 7 mm

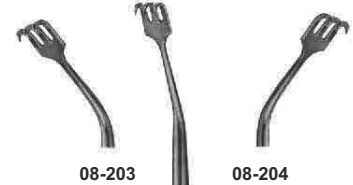

08-203

08-204



08-202 - 204
WILLIGER
120 mm

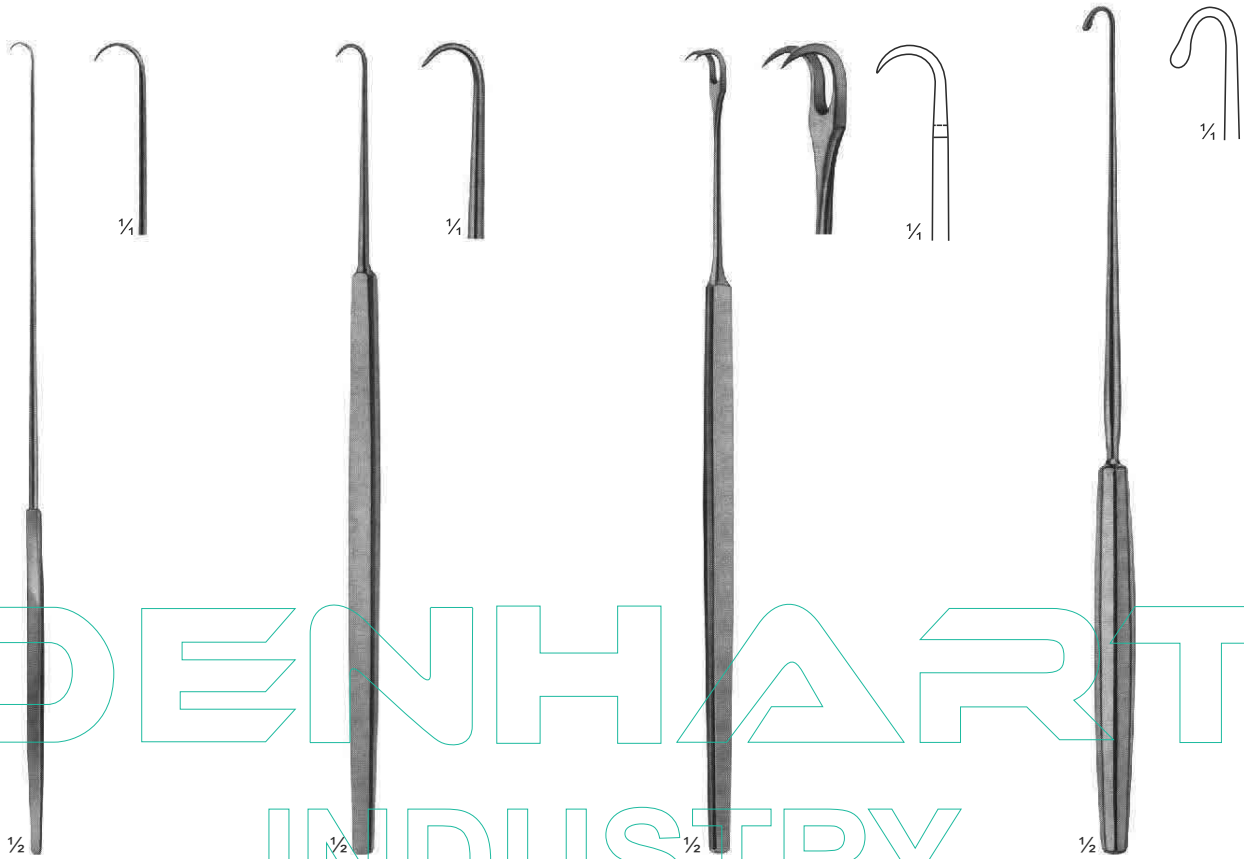

08-205
EMMET
Fistula hook
220 mm

08-206
SIMON
Fistula hook
220 mm

08-207
SIMON
Fistula hook
220 mm

08-208
LANGE
Fistula hook
230 mm

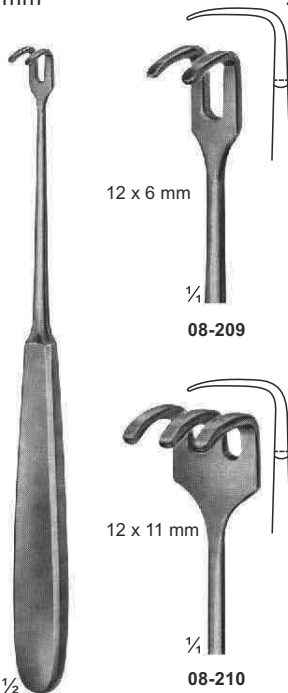

12 x 6 mm

1/4

08-209

12 x 11 mm

1/4

08-210

08-209 - 210
Tendon hooks
175 mm

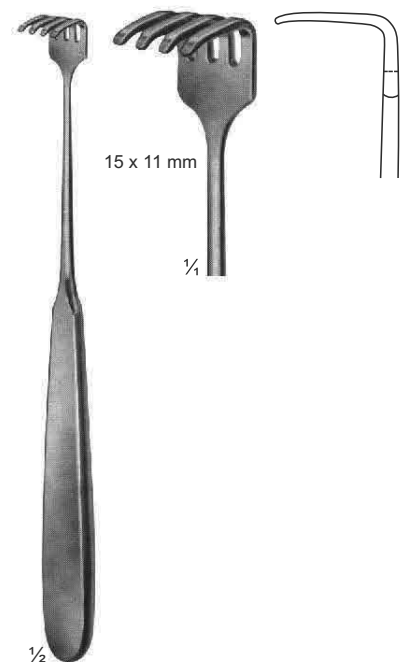

15 x 11 mm

1/4

1/2

08-211
KLAPP
Tendon hooks
175 mm

DENHART
INDUSTRY



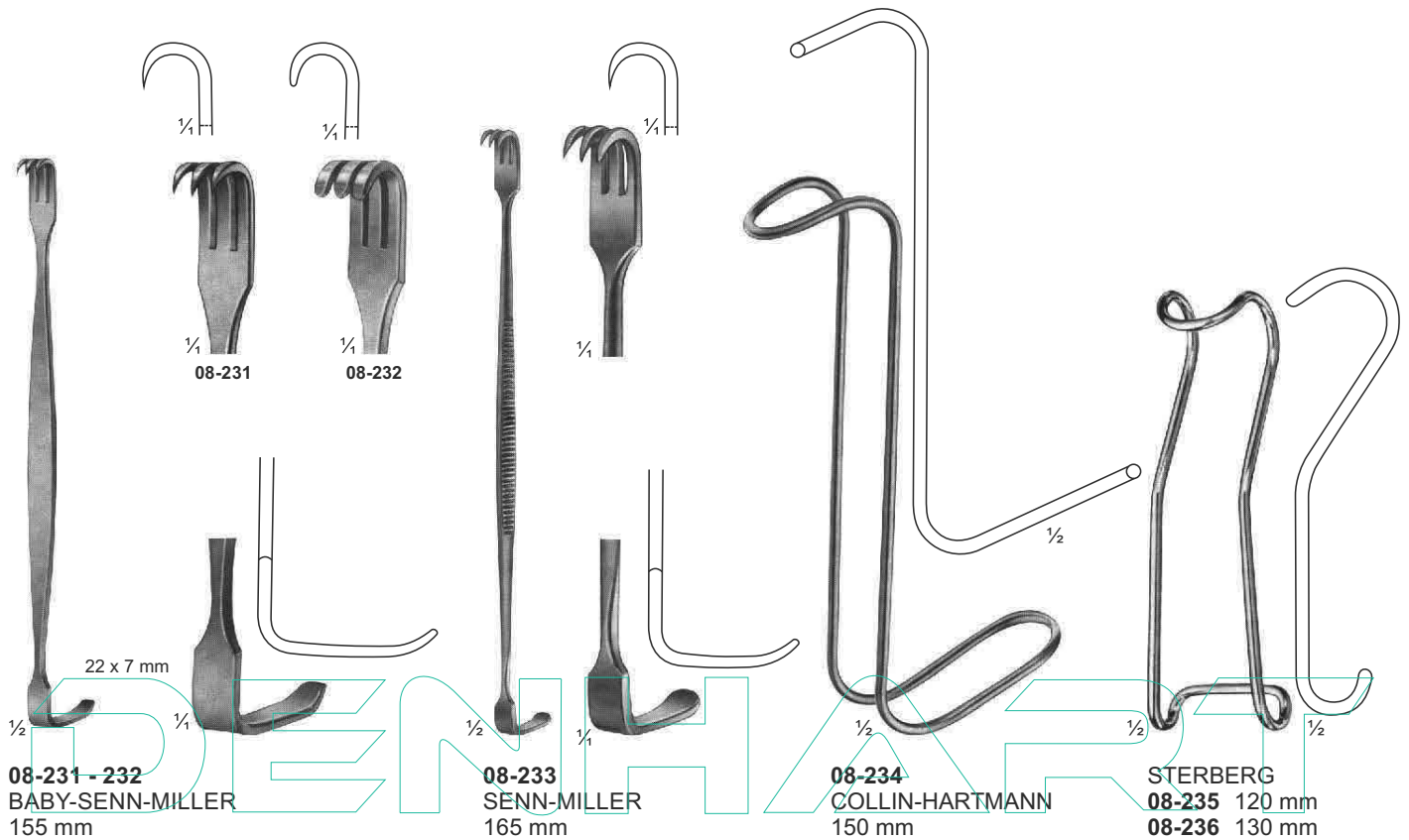

08-231 - 232
BABY-SENN-MILLER
155 mm

08-233
SENN-MILLER
165 mm

08-234
COLLIN-HARTMANN
150 mm

STERBERG
08-235 120 mm
08-236 130 mm
08-237 135 mm
08-238 140 mm

INDUSTRY

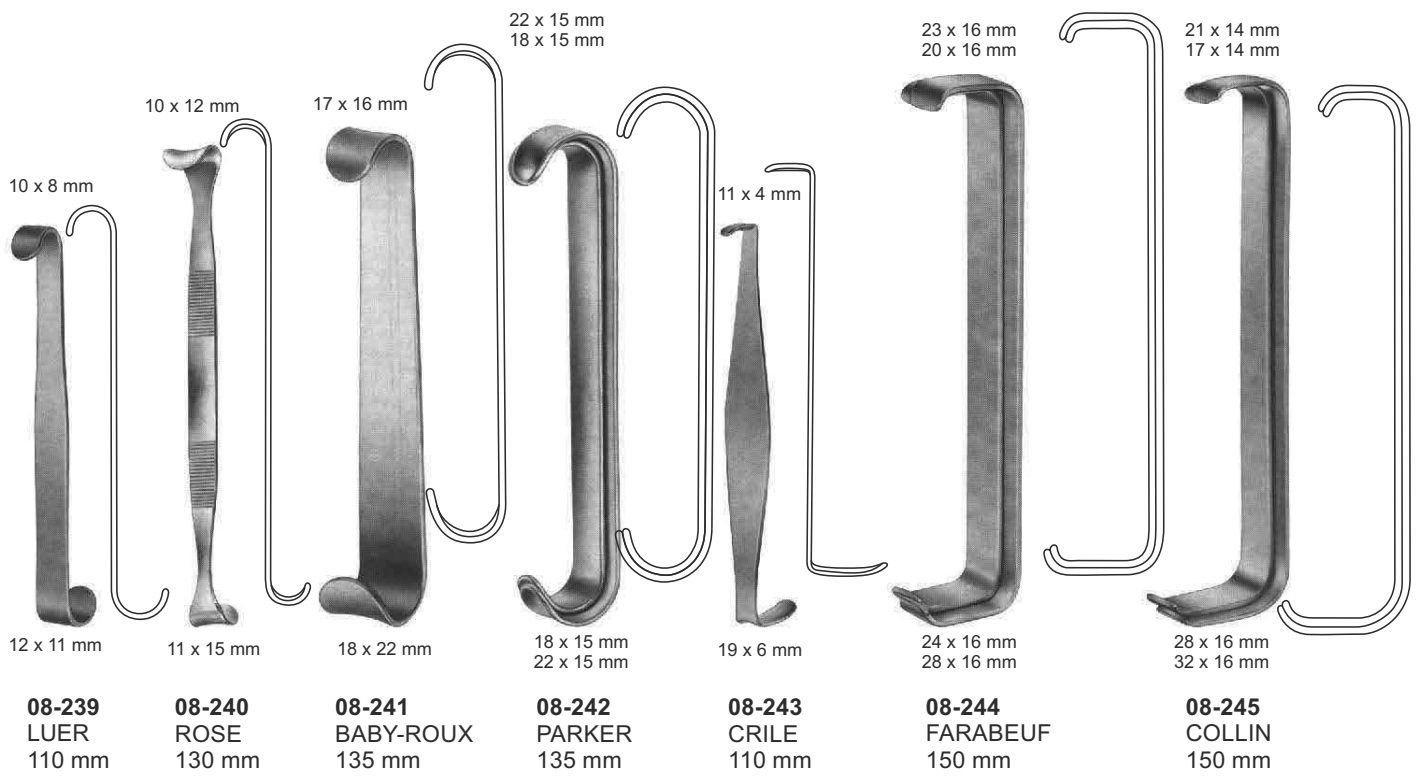

08-239
LUER
110 mm

08-240
ROSE
130 mm

08-241
BABY-ROUX
135 mm

08-242
PARKER
135 mm

08-243
CRILE
110 mm

08-244
FARABEUF
150 mm

08-245
COLLIN
150 mm

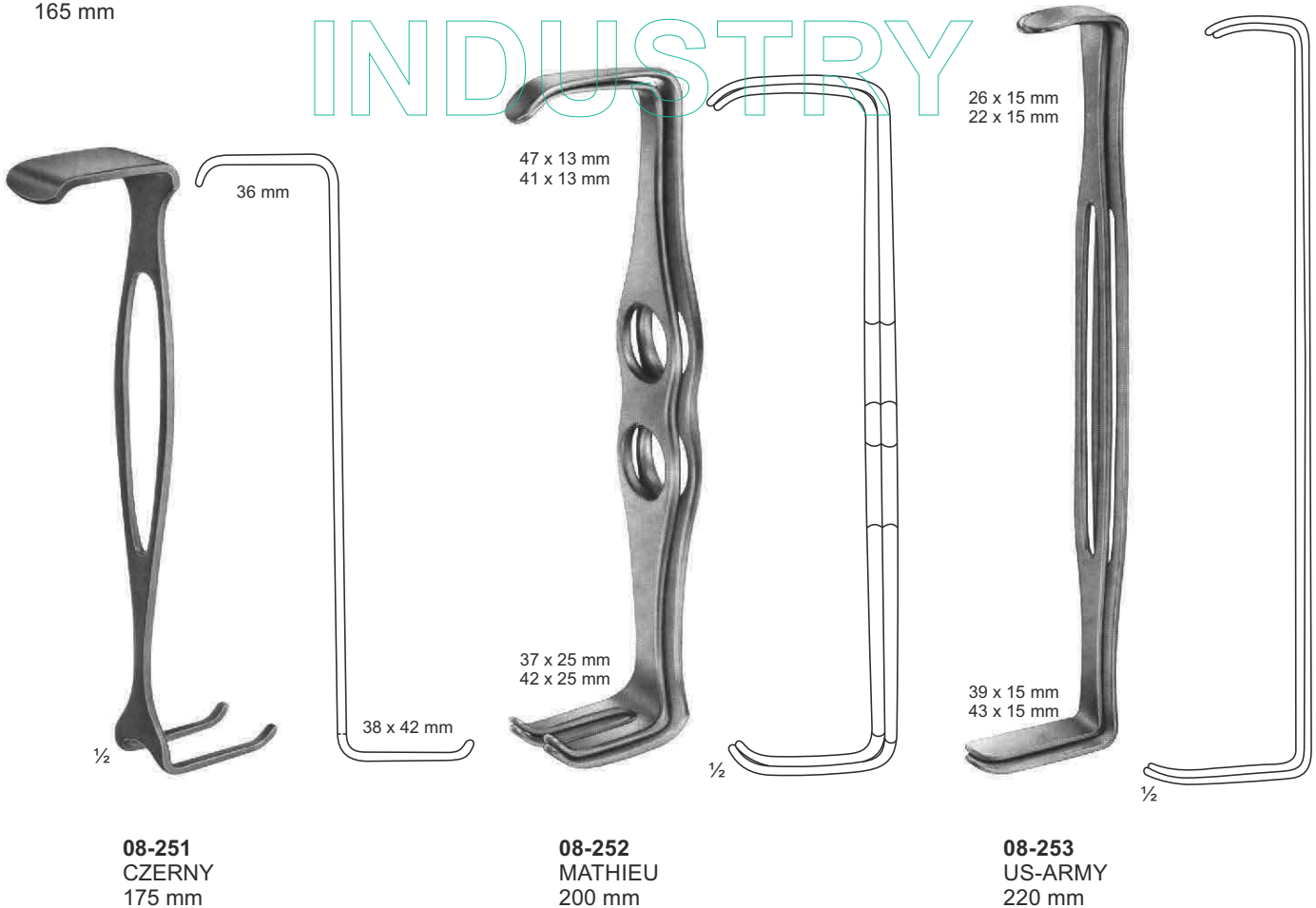
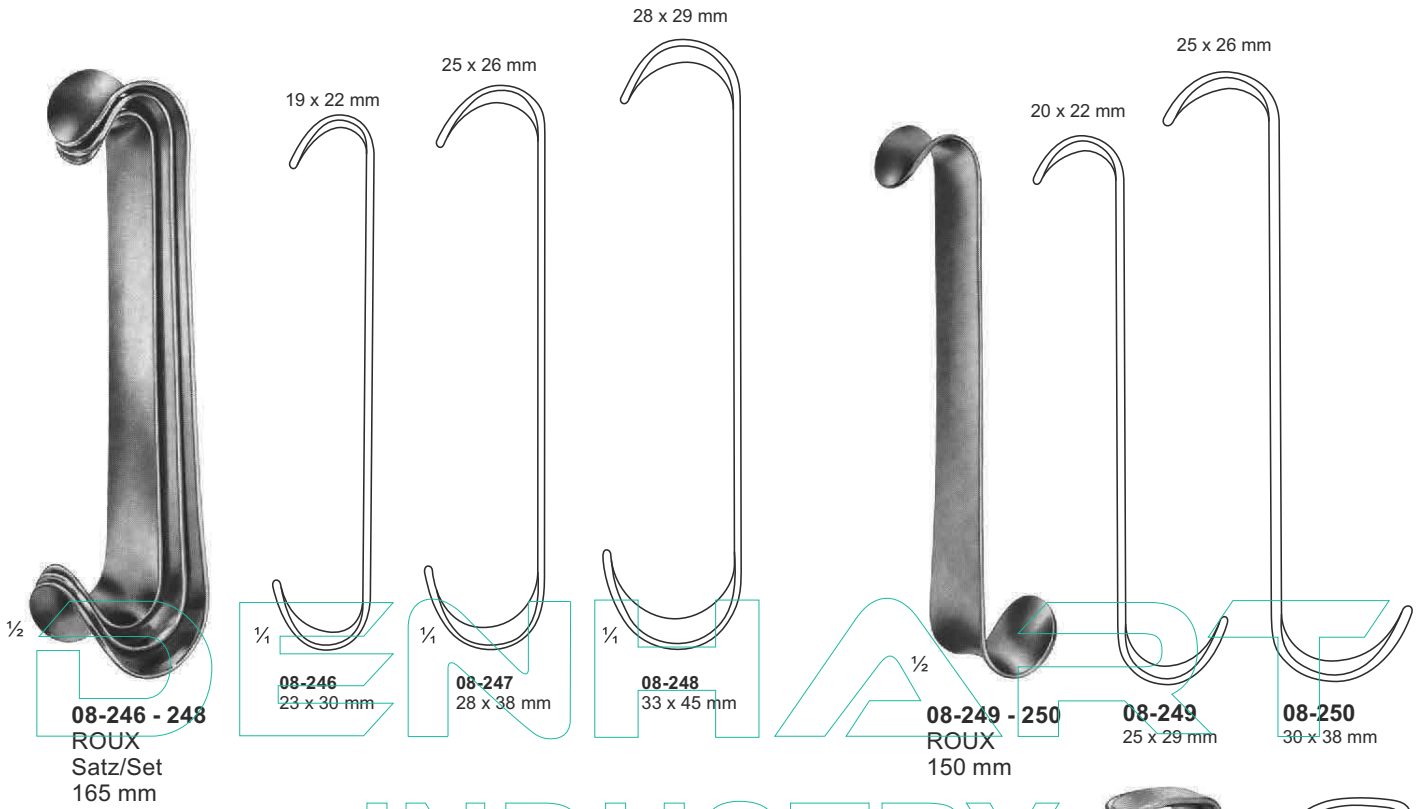



08-254
KOCHER
Sharp
205 mm



08-255
KOCHER
Sharp
220 mm



08-256
KOCHER
Blunt
220 mm



08-257
VOLKMANN
Sharp
220 mm



08-258
VOLKMANN
Sharp
220 mm



08-259 - 266
VOLKMANN
225 mm

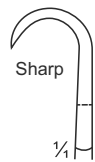

Sharp



08-259
9 x 8 mm



08-260
9 x 13 mm



08-261
9 x 19 mm



08-262
9 x 29 mm

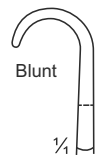

Blunt



08-263
8,5 x 8 mm



08-264
8,5 x 13 mm



08-265
8,5 x 19 mm



08-266
8,5 x 29 mm

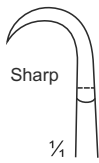

08-267
9 x 8 mm



08-268
9 x 13 mm



08-269
9 x 19 mm



08-270
9 x 29 mm



08-271
9 x 40 mm

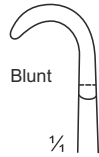

08-272
8 x 8 mm



08-273
8 x 13 mm



08-274
8 x 19 mm



08-275
8 x 29 mm



08-276
8 x 40 mm



08-277
8,5 x 8 mm



08-278
8,5 x 13 mm



08-279
8,5 x 19 mm



08-280
8,5 x 29 mm

08-267 - 280
VOLKMANN
220 mm

1/2

DENHART
INDUSTRY

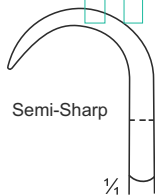

08-281
16 x 9 mm



08-282
16 x 14 mm



08-283
16 x 20 mm



08-284
16 x 30 mm

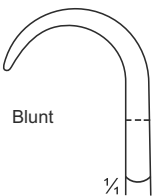

08-285
15,5 x 9 mm



08-286
15,5 x 14 mm



08-287
15,5 x 20 mm



08-288
15,5 x 30 mm

08-281 - 288
KOCHER
220 mm

1/2

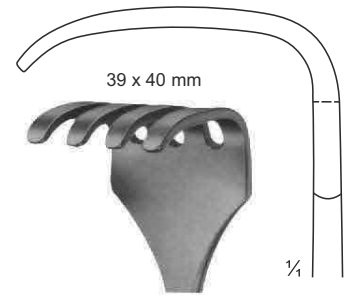

08-291
4 Prongs, blunt

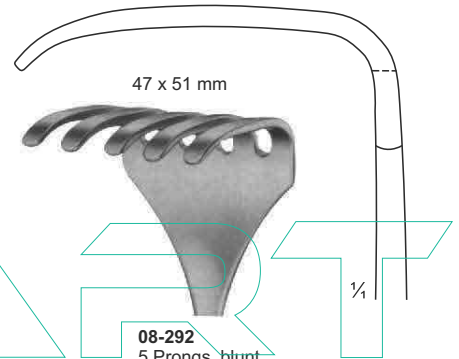

08-292
5 Prongs, blunt

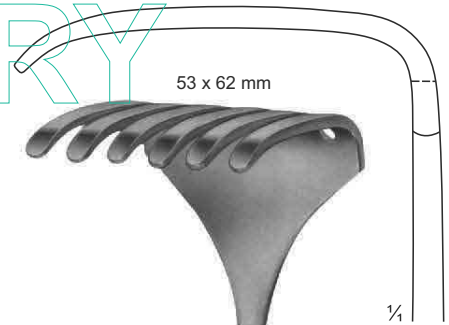

08-293
6 Prongs, blunt

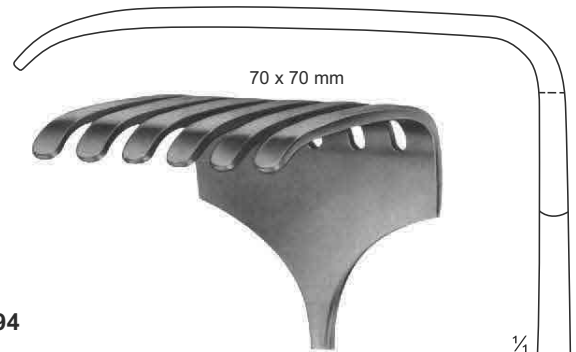

08-294
6 Prongs, blunt



08-289 - 290
KORTE
240 mm

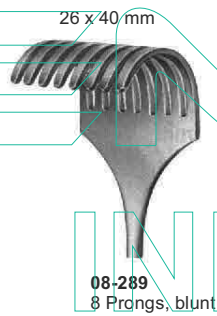

08-289
8 Prongs, blunt

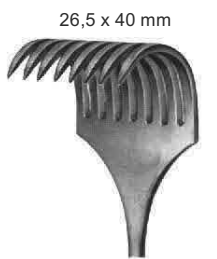

08-290
8 Prongs, sharp



08-291 - 294
ISRAEL
255 mm

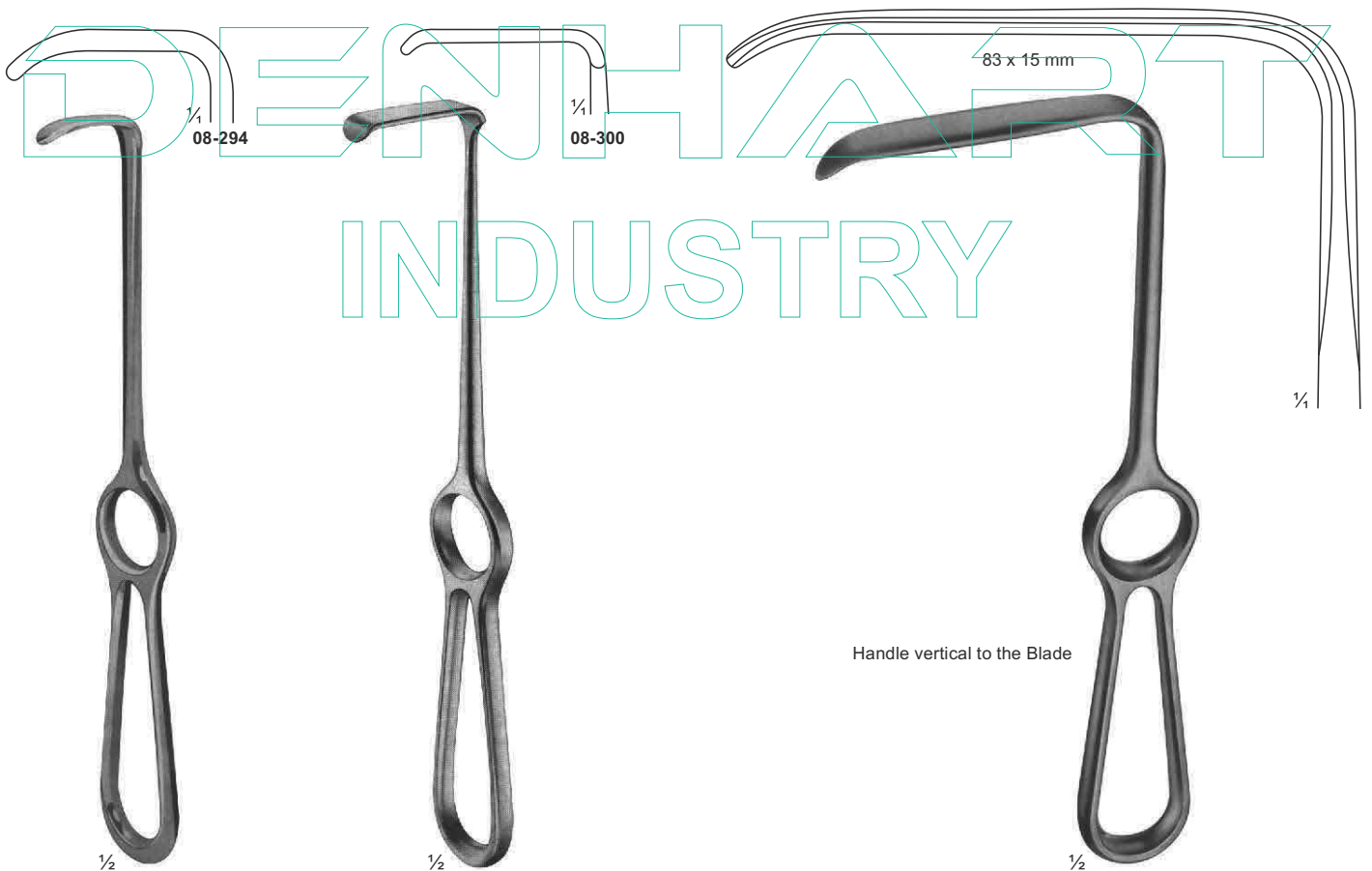

- 08-295 - 300**
LANGENBECK
210 mm
- 08-295 28 x 10 mm
 - 08-296 28 x 14 mm
 - 08-297 33 x 14 mm
 - 08-298 28 x 16 mm
 - 08-299 40 x 10 mm
 - 08-300 40 x 13 mm

- 08-301 - 307**
KOCHER-LANGENBECK
215 mm
- 08-301 25 x 6 mm
 - 08-302 35 x 8 mm
 - 08-303 35 x 11 mm
 - 08-304 35 x 15 mm
 - 08-305 41 x 11 mm
 - 08-306 55 x 11 mm
 - 08-307 70 x 14 mm

- 08-308**
LANGENBECK
215 mm



08-309 - 313
KOCHER
230 mm

1/2

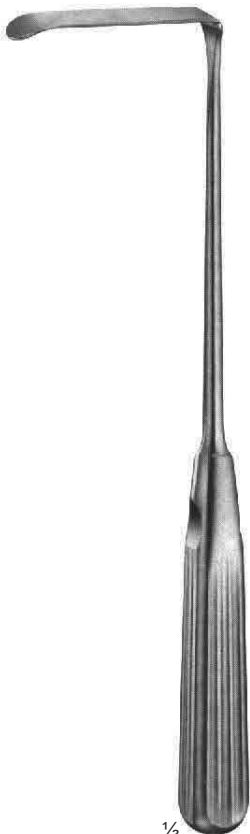

08-314 - 316
SAUERBRUCH
225 mm

1/2

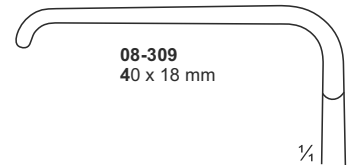

08-309
40 x 18 mm

1/4

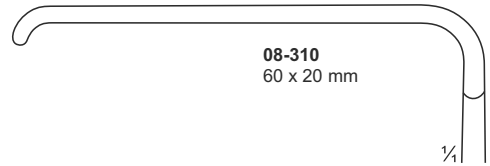

08-310
60 x 20 mm

1/4

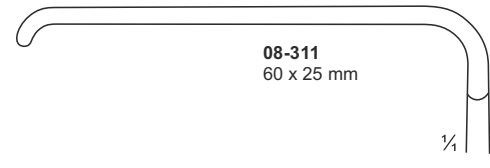

08-311
60 x 25 mm

1/4

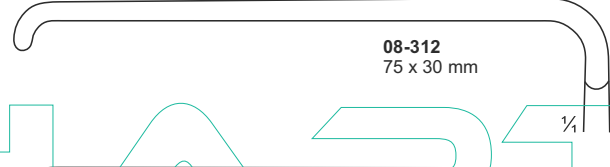

08-312
75 x 30 mm

1/4



08-313
75 x 40 mm

1/4

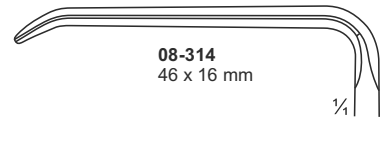

08-314
46 x 16 mm

1/4

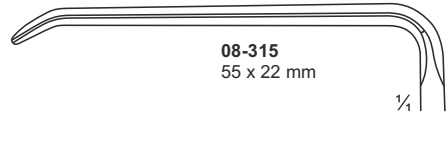

08-315
55 x 22 mm

1/4

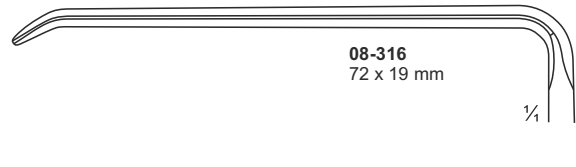

08-316
72 x 19 mm

1/4

DENHART
INDUSTRY



08-317
15 x 15 mm
220 mm

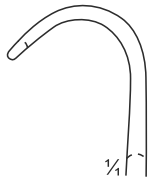

1/4



08-318
20 x 22 mm
215 mm

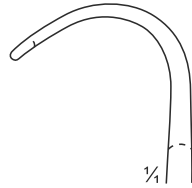

1/4



08-319
28 x 28 mm
235 mm

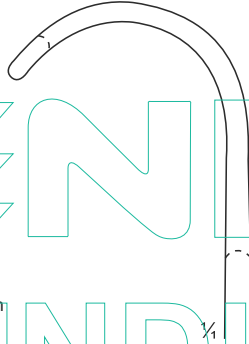

1/4

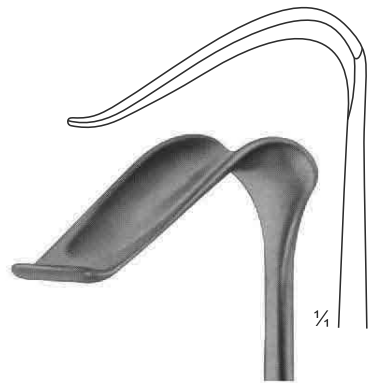

38 x 18 mm

1/4

08-320
BUCHS
205 mm

1/2

08-317 - 319
MIDDELDORPF

1/2

DENHART
INDUSTRY

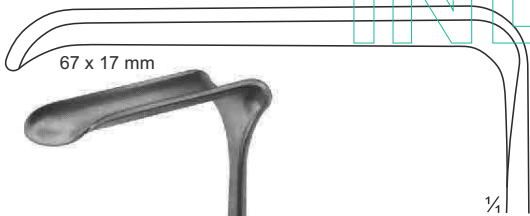

67 x 17 mm

1/4



08-321
CASPAR
210 mm

1/2

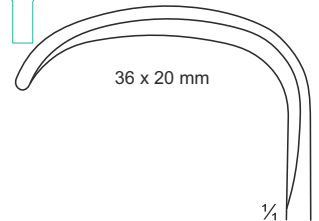

36 x 20 mm

1/4

08-322
KOCHER
230 mm

1/2

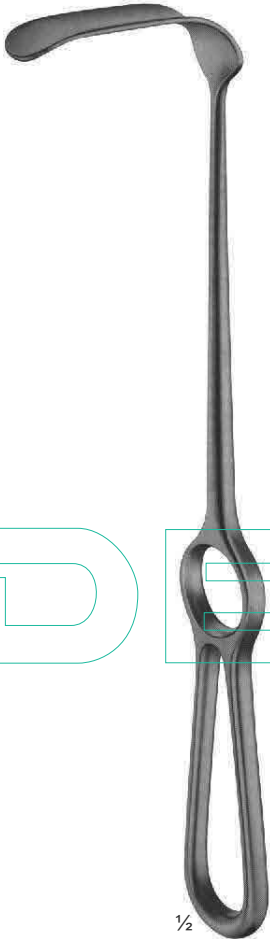

1/2

08-323 - 328
HOSEL
250 mm

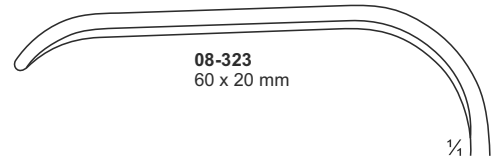

08-323
60 x 20 mm

1/4

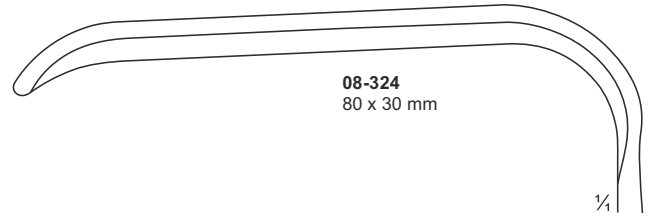

08-324
80 x 30 mm

1/4

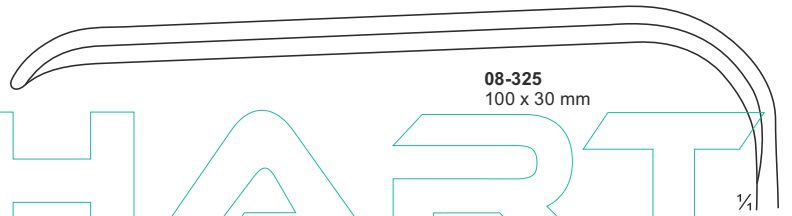

08-325
100 x 30 mm

1/4

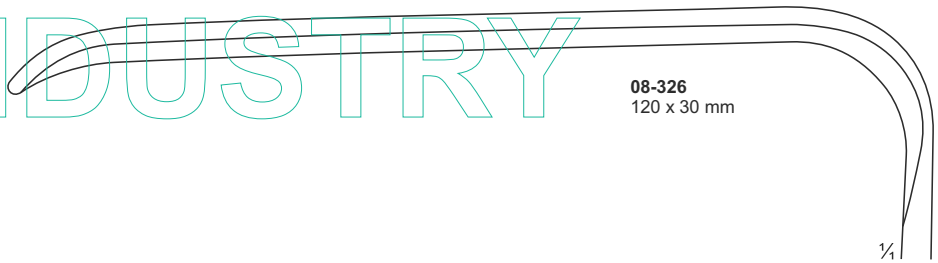

08-326
120 x 30 mm

1/4

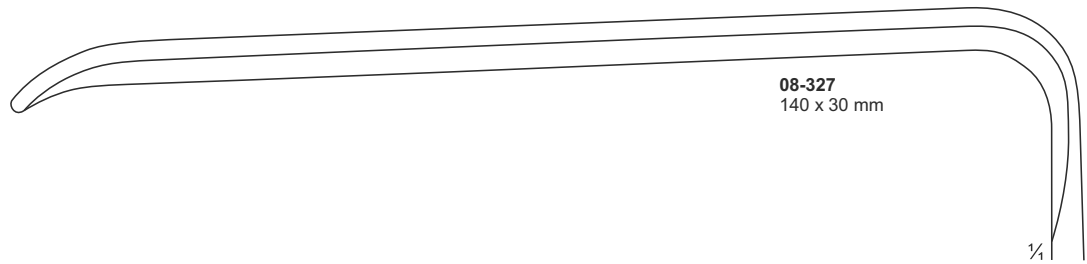

08-327
140 x 30 mm

1/4

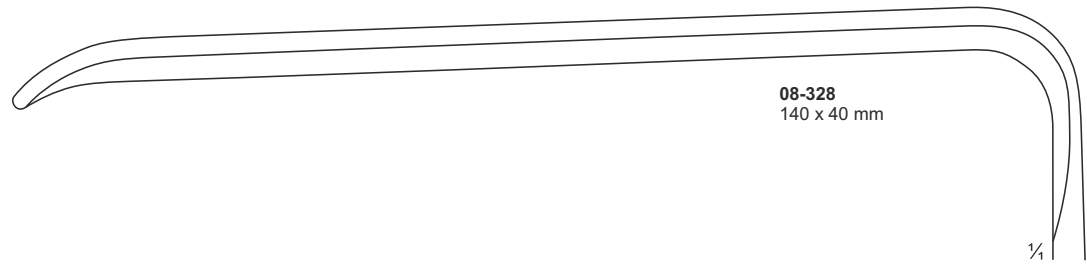

08-328
140 x 40 mm

1/4

DENHART
INDUSTRY

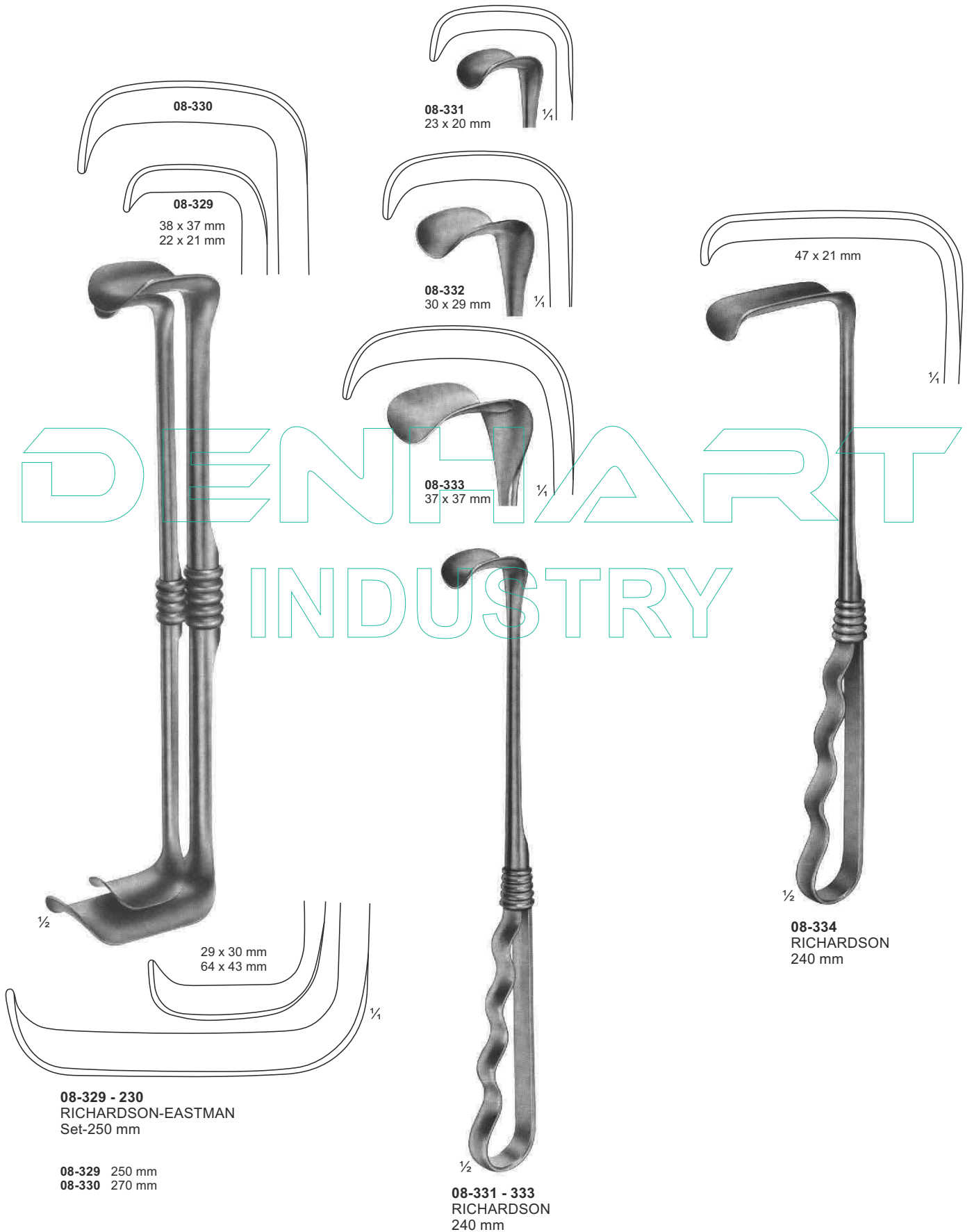

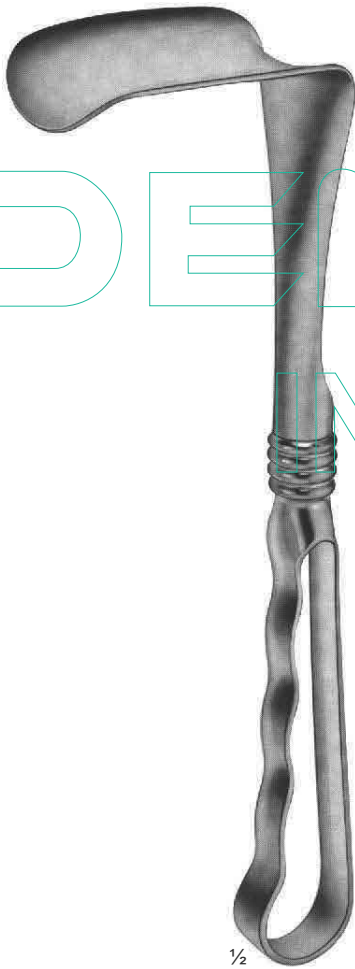
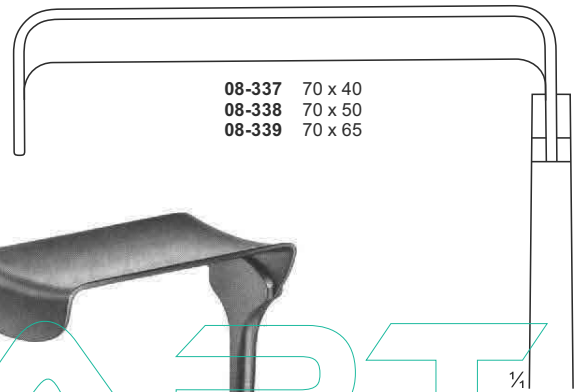
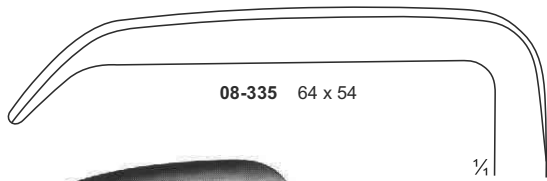
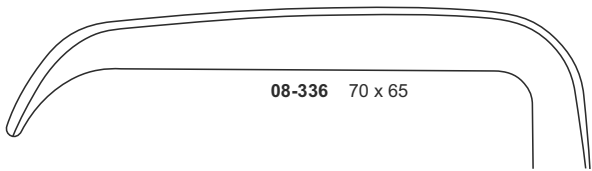

1/2
08-335 - 336
KELLY
260 mm



1/2
08-337 - 339
MORRIS
245 mm

DENHART
INDUSTRY

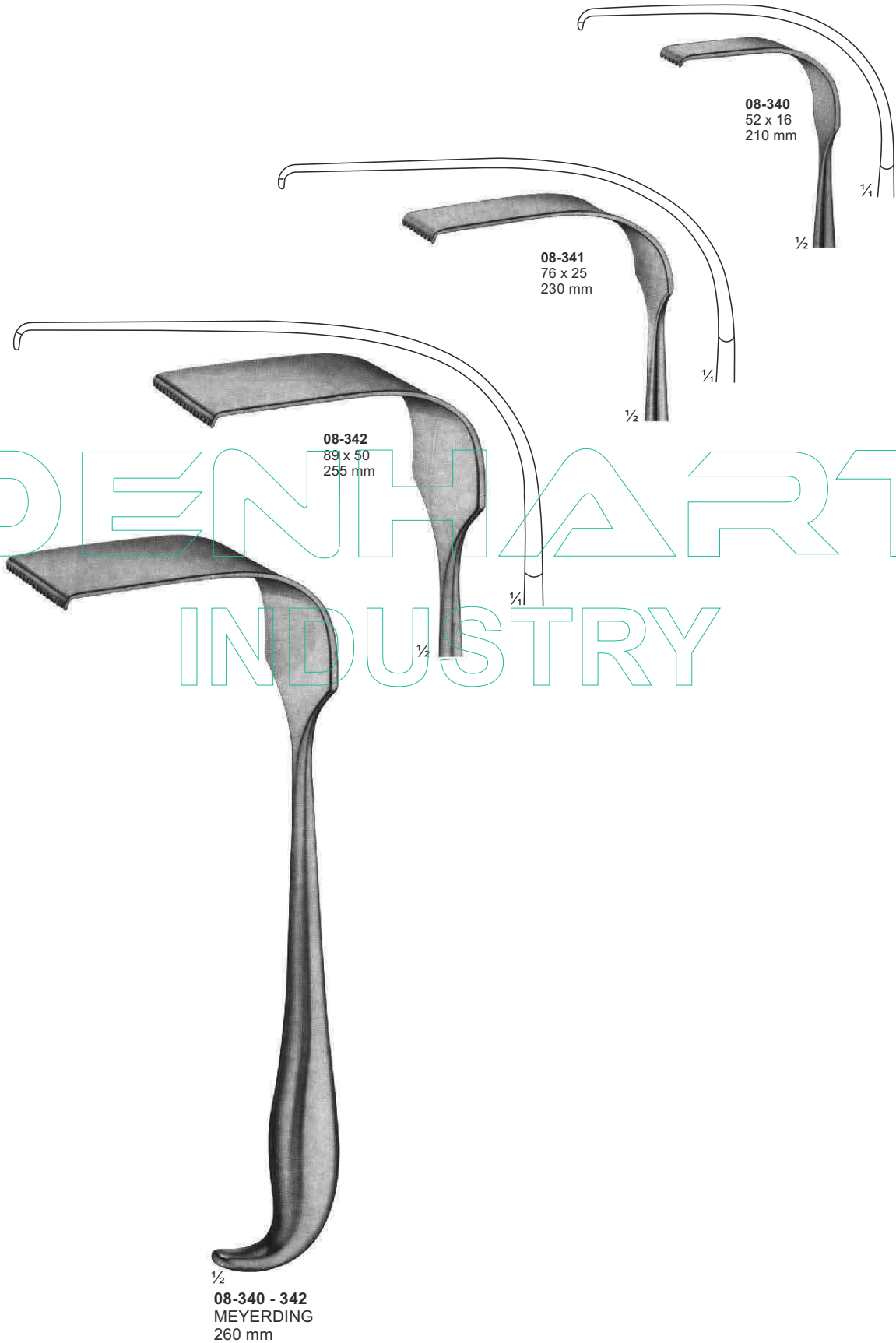



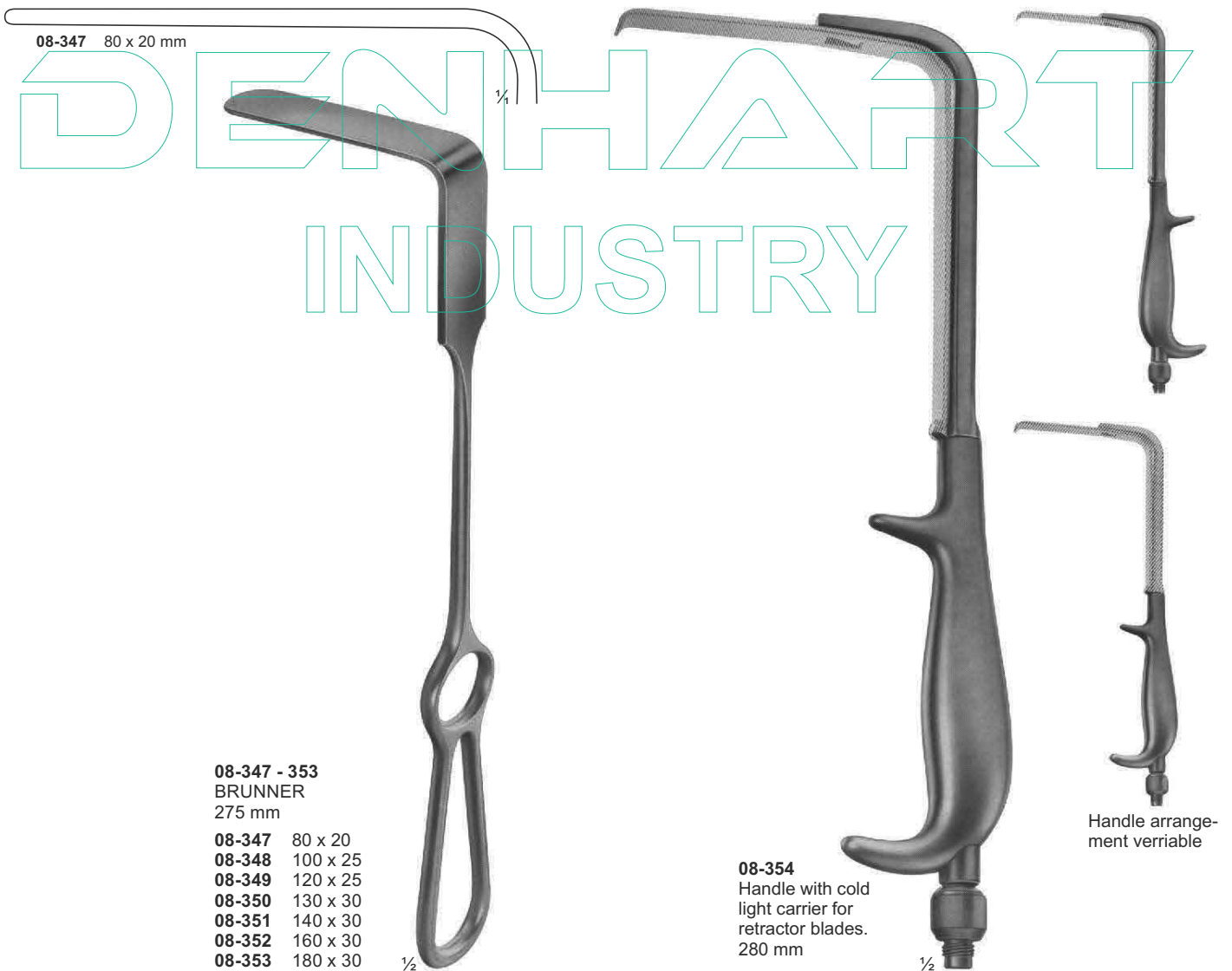

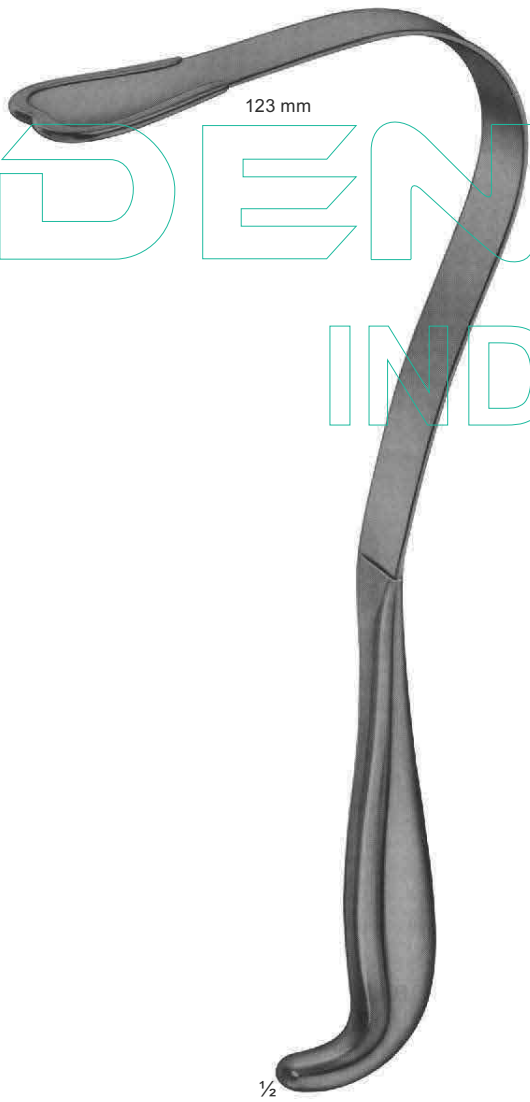
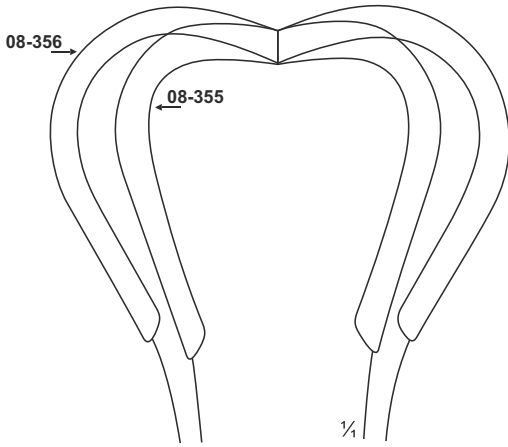

08-355 - 356
HARRINGTON
08-355 123 x 45 mm
08-356 123 x 64 mm
 Flexible
 295 mm



08-357
ALLISON
 255 mm

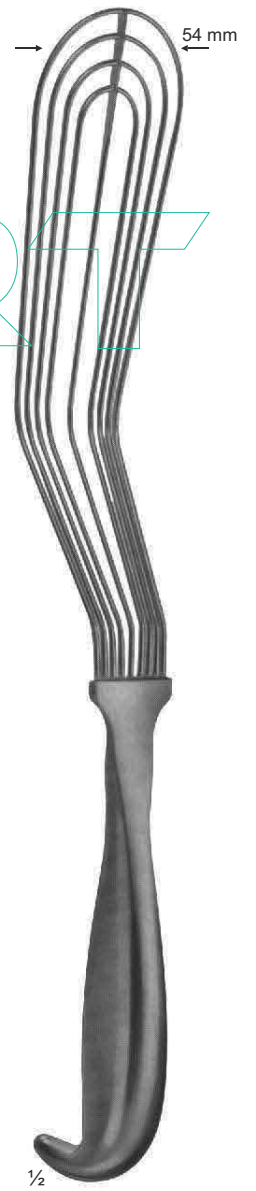

08-358
ALLISON
 320 mm

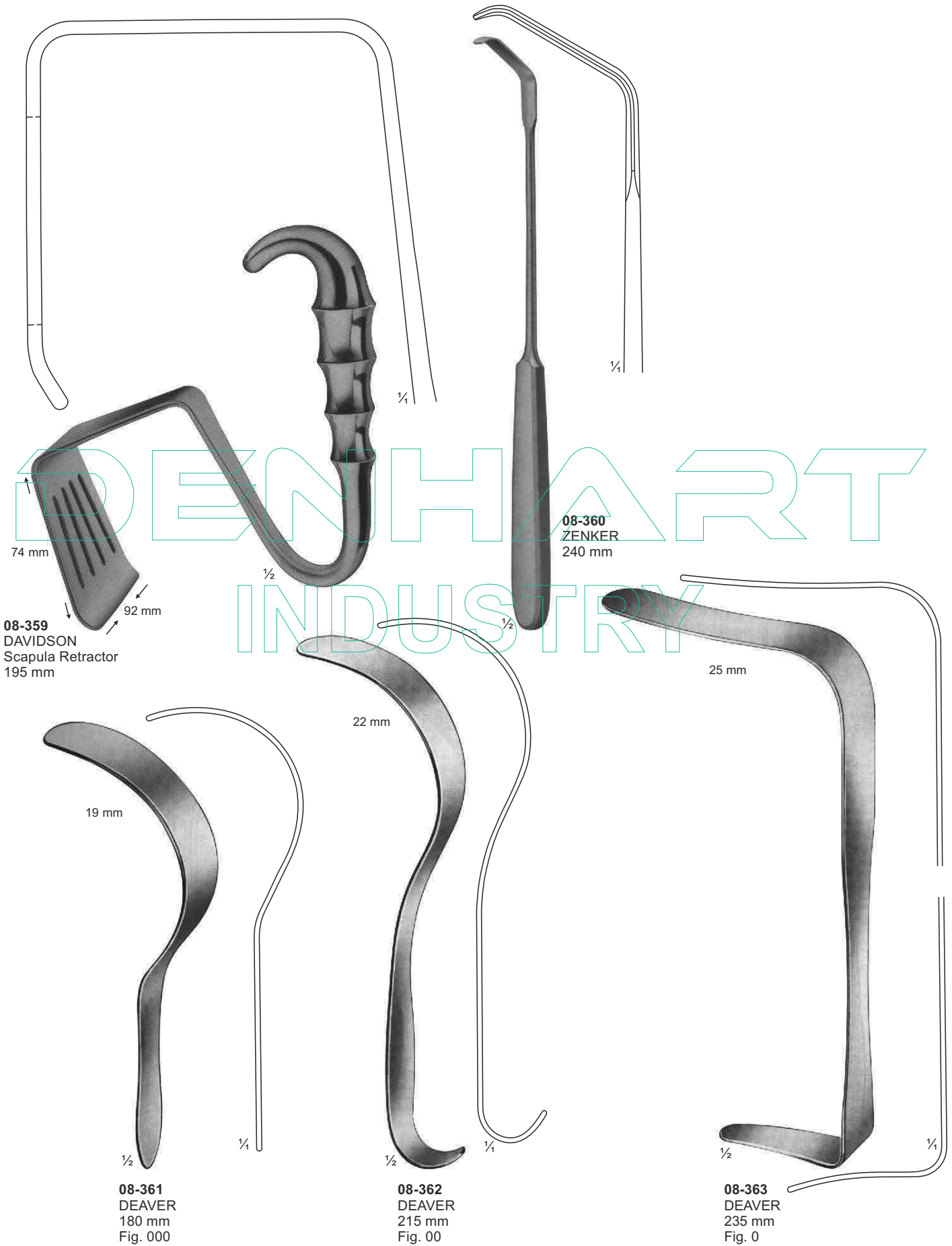



08-364
DEAVER
300 mm
Fig. 1

08-365
DEAVER
315 mm
Fig. 2

08-366
DEAVER
365 mm
Fig. 2

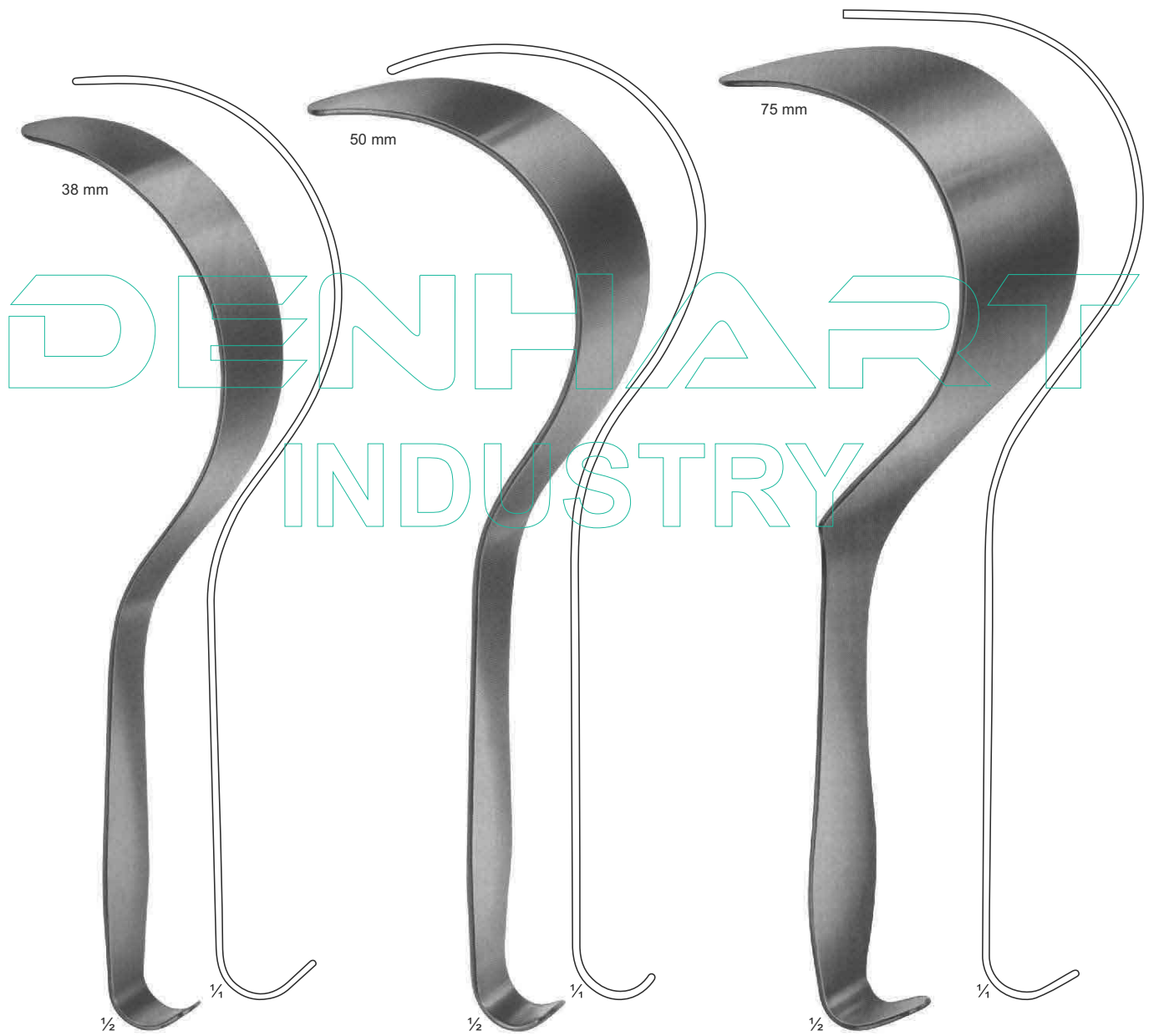

08-367
DEAVER
300 mm
Fig. 3

08-368
DEAVER
310 mm
Fig. 4

08-369
DEAVER
320 mm
Fig. 5

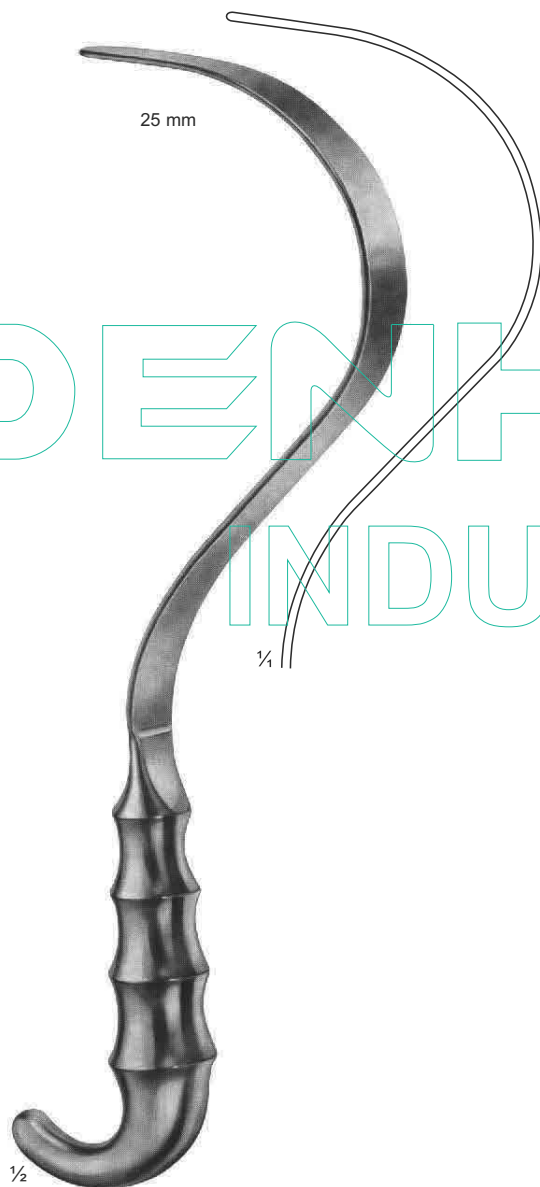

08-370
DEAVER
310 mm
Fig. 1

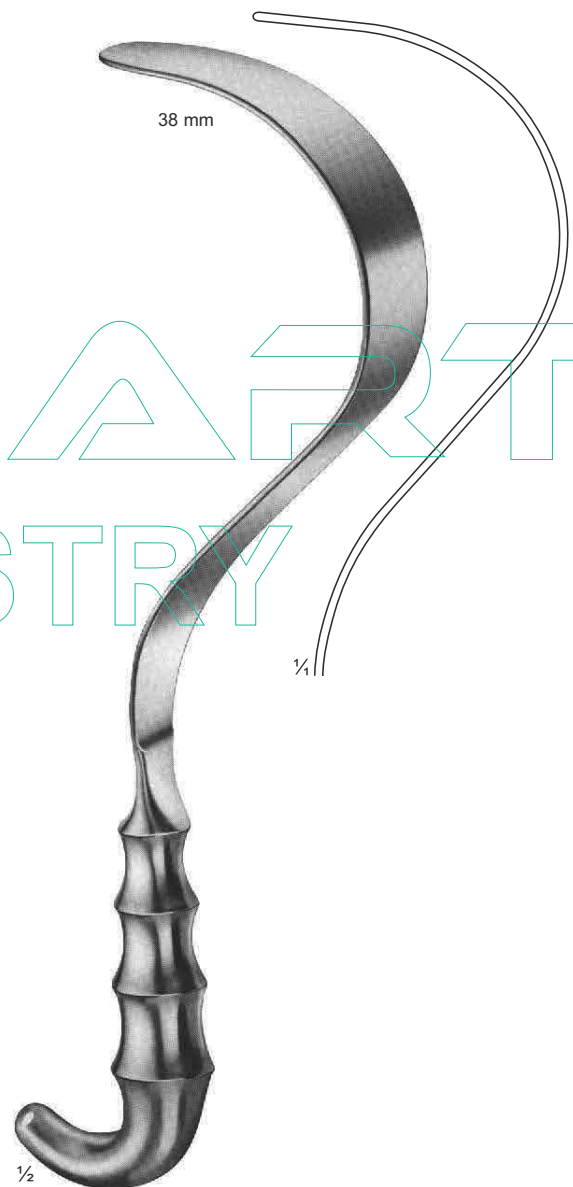

08-371
DEAVER
310 mm
Fig. 3



08-372
DEAVER
305 mm
Fig. 3



08-373
DEAVER
310 mm
Fig. 4

Retractors For Deep Surgery (Abdominal Retractors)

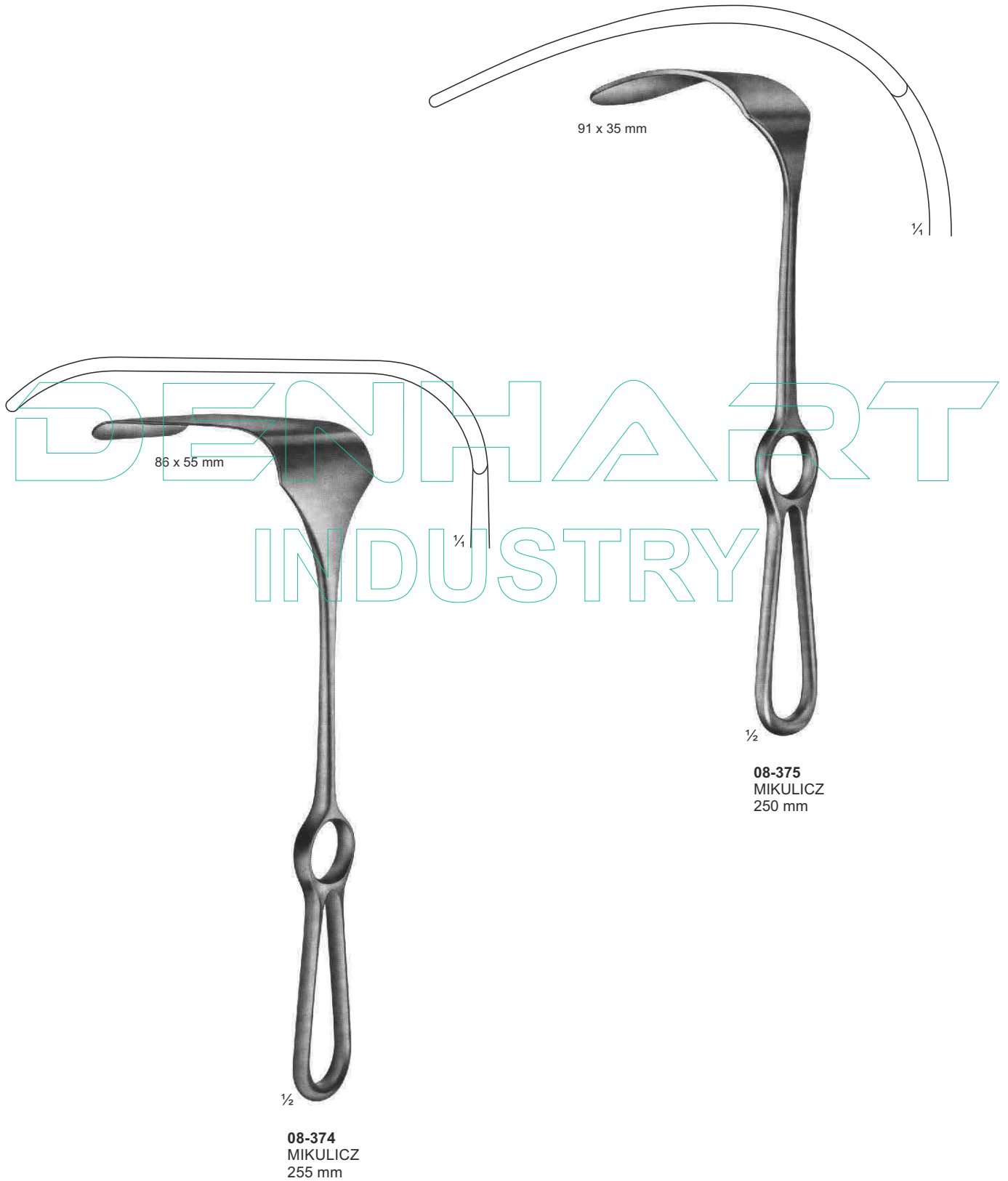

Retractors For Deep Surgery (Abdominal Retractors)

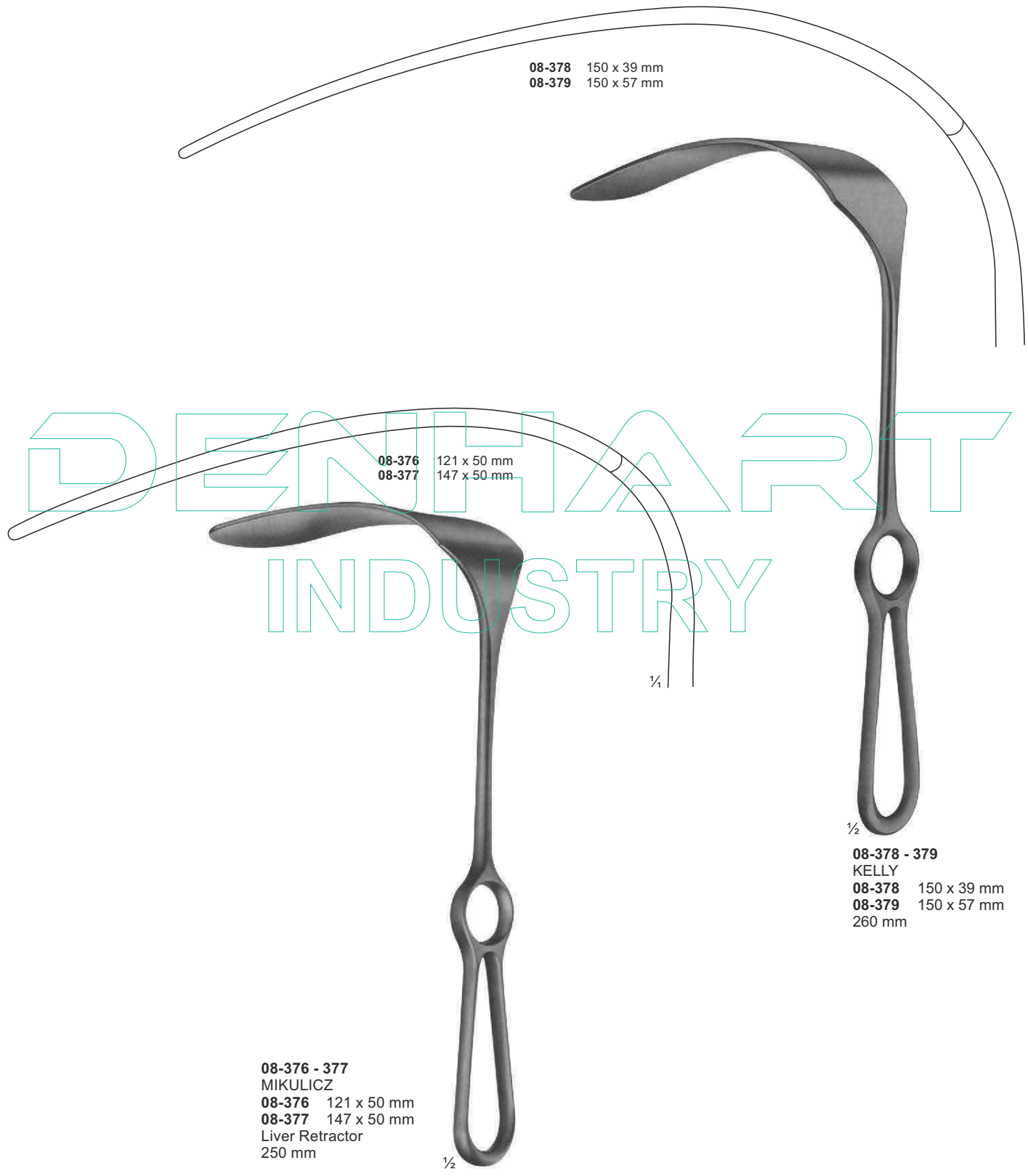

08-378 150 x 39 mm
08-379 150 x 57 mm

08-376 121 x 50 mm
08-377 147 x 50 mm

08-378 - 379
KELLY
08-378 150 x 39 mm
08-379 150 x 57 mm
260 mm

08-376 - 377
MIKULICZ
08-376 121 x 50 mm
08-377 147 x 50 mm
Liver Retractor
250 mm

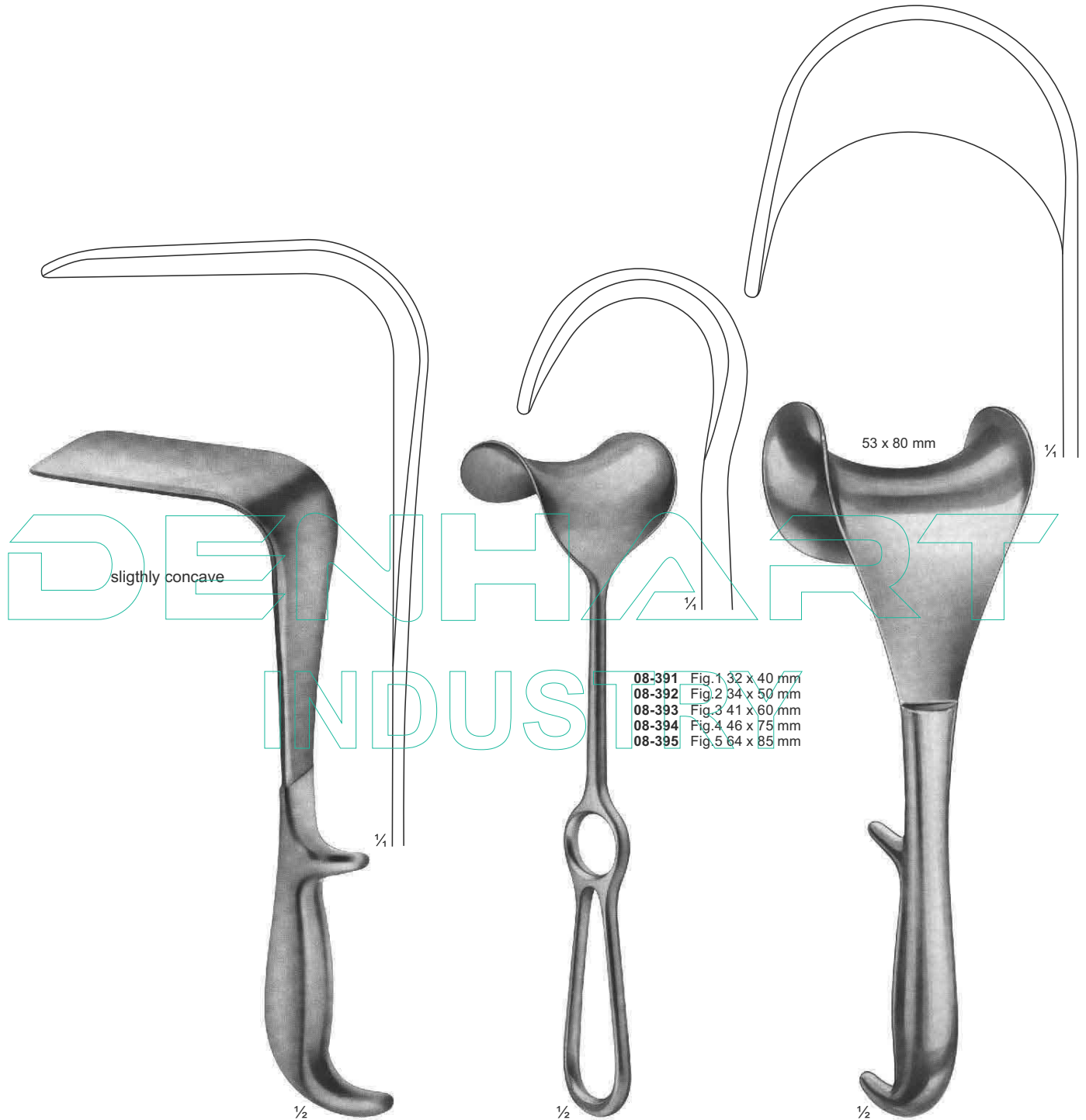

- 08-391 Fig.1 32 x 40 mm
- 08-392 Fig.2 34 x 50 mm
- 08-393 Fig.3 41 x 60 mm
- 08-394 Fig.4 46 x 75 mm
- 08-395 Fig.5 64 x 85 mm

08-380 - 390
DOYEN
240 mm

08-391 - 395
FRITSCH
240 mm

08-396
DOYEN
250 mm

Width of Blades	35 mm, 45 mm, 60 mm
Length of Blades	08-380, 08-381, 08-382 08-383, 08-384, 08-385 08-386, 08-387, 08-388 08-389, 08-390
62 mm	
92 mm	
122 mm	
160 mm	



08-397 - 401
ROCHARD
310 mm
08-397 48 x 90 mm
08-398 48 x 105 mm
08-399 48 x 120 mm
08-400 48 x 135 mm
08-401 48 x 155 mm



08-402

INDUSTRY



08-403 - 406
DOYEN
280 mm
08-403 48 x 90 mm
08-404 48 x 105 mm
08-405 48 x 120 mm
08-406 48 x 135 mm



08-407
DOYEN-CHILD
Fixation device
220 mm



08-408
Chain with
weight (747 / 645g)
790 mm

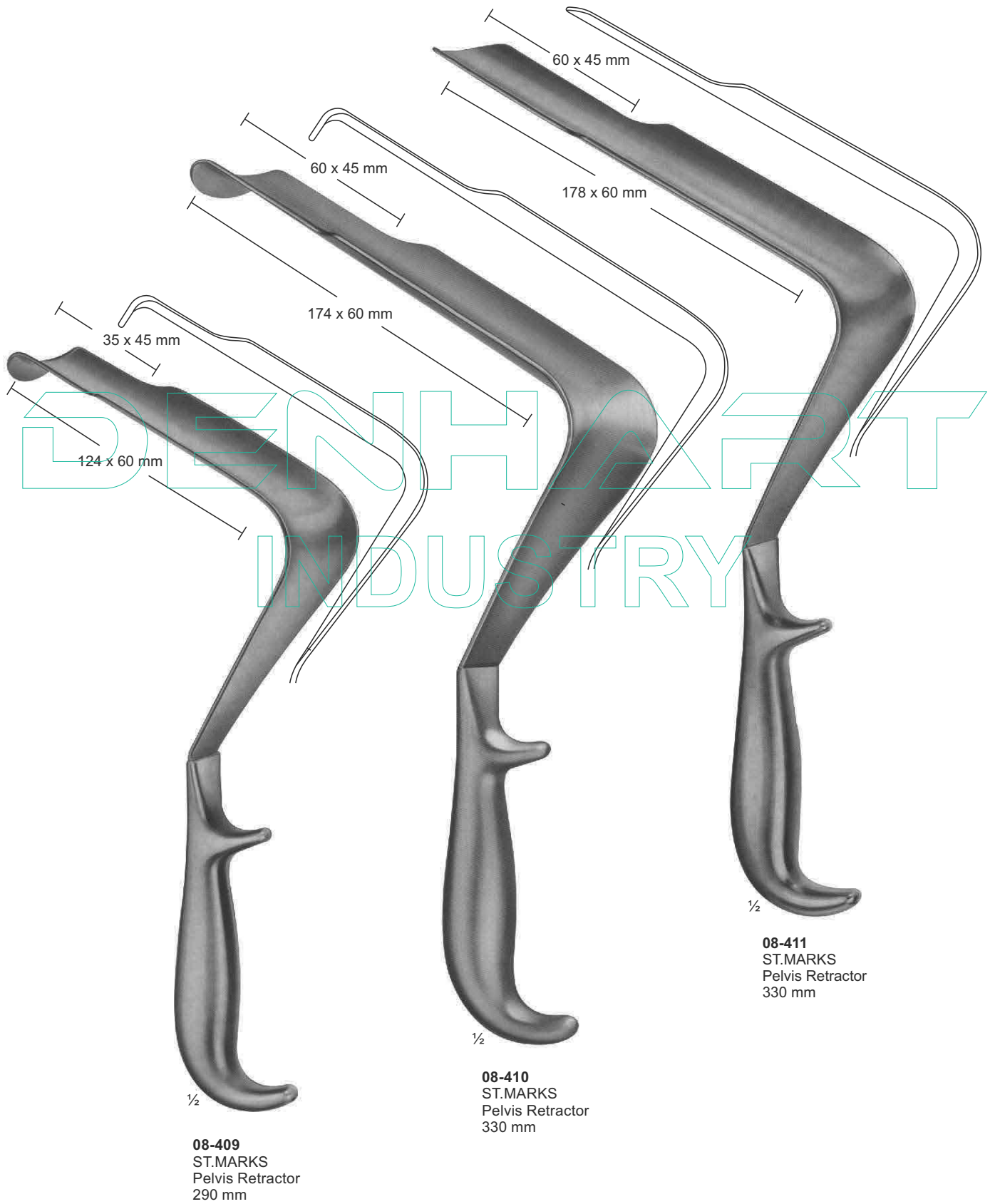

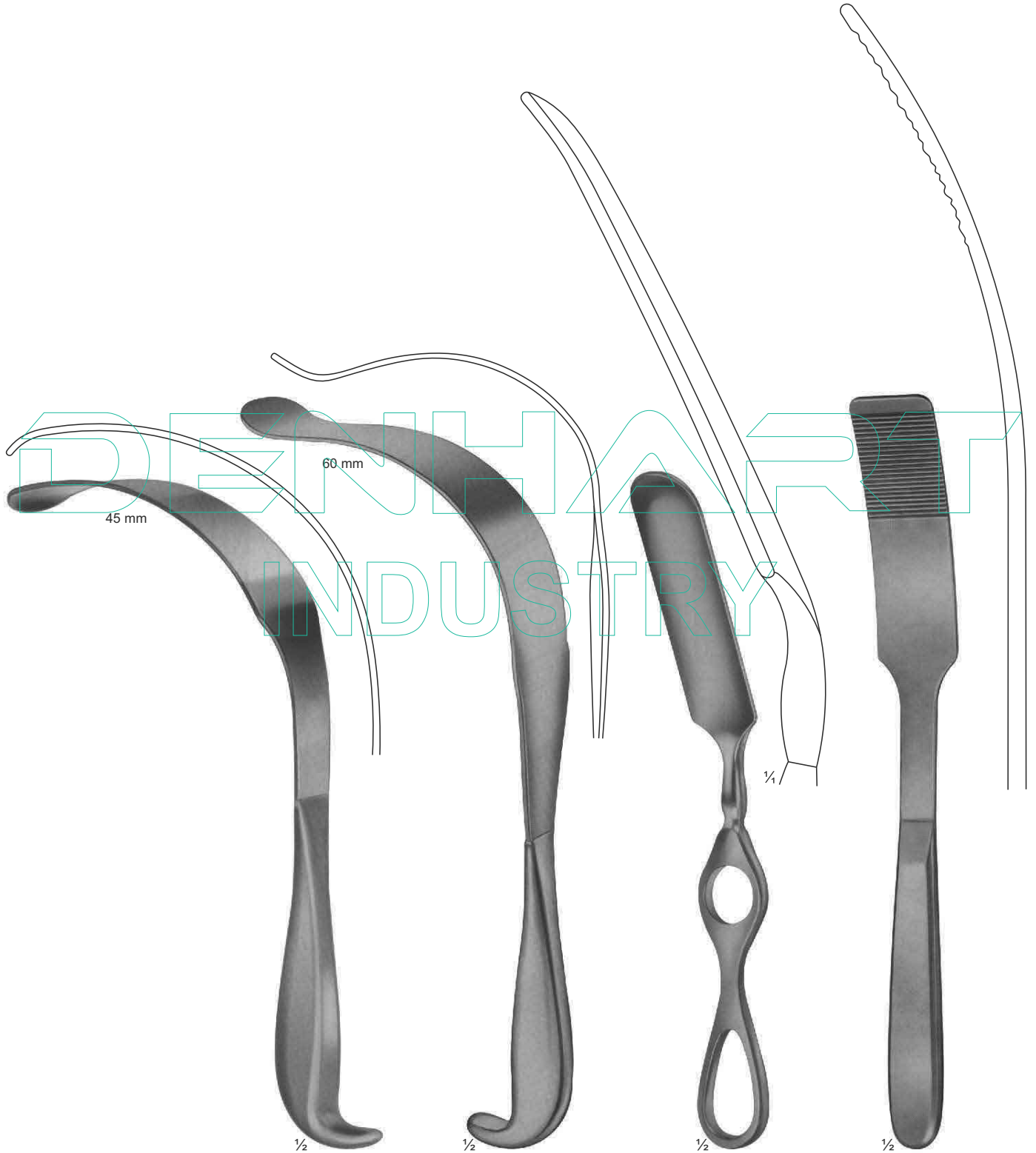

08-412
LERICHE
255 mm

08-413
KUMMEL
Melleable
285 mm

08-414
MIKULICZ
29 mm
250 mm

08-415 - 416
KADER
08-415 30 mm
08-416 40 mm
270 mm

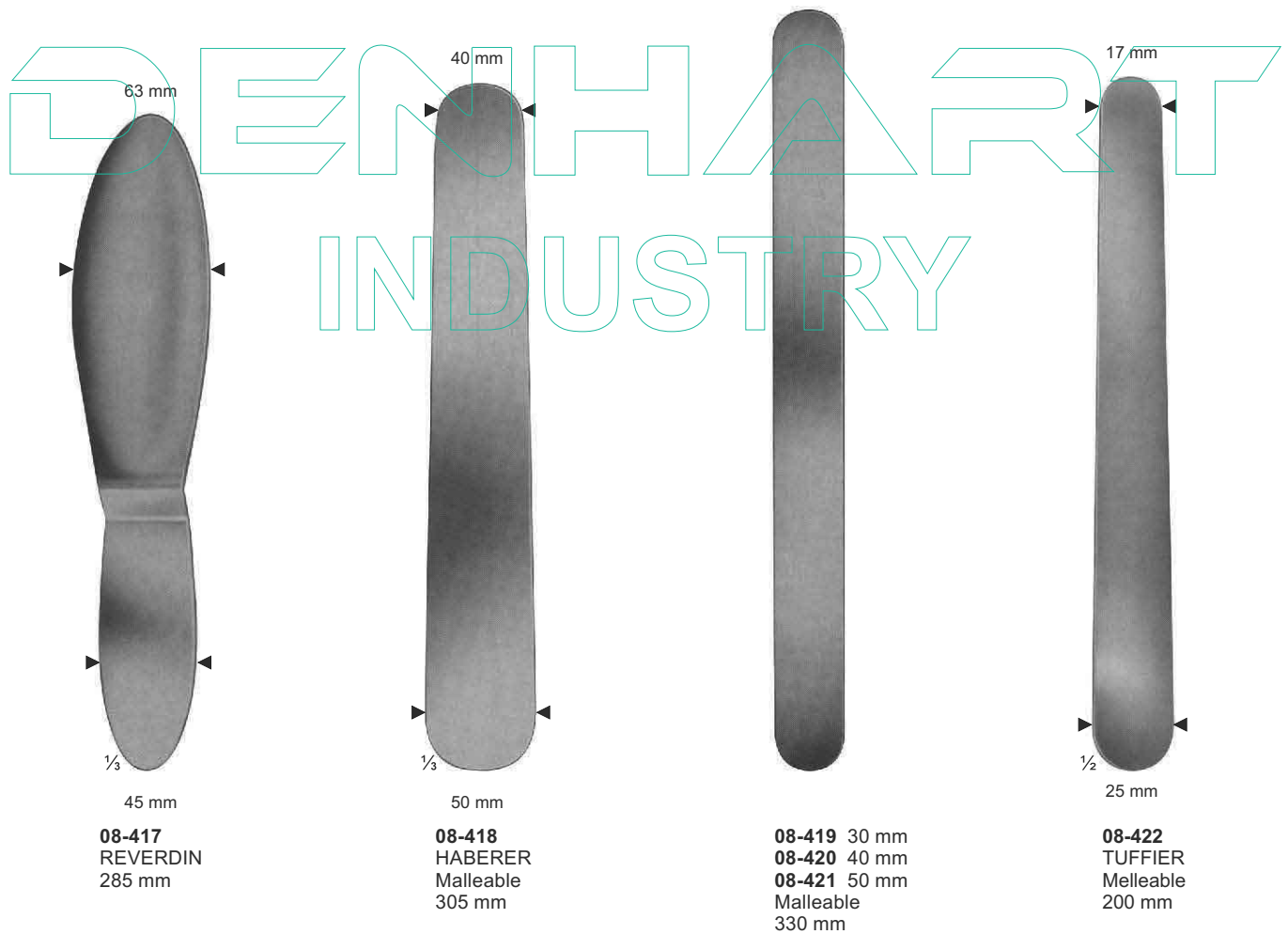



08-423
BOSE
60 mm



08-424
FINSEN
50 mm



08-425
FINSEN
70 mm



08-426
FINSEN modif.
75 mm

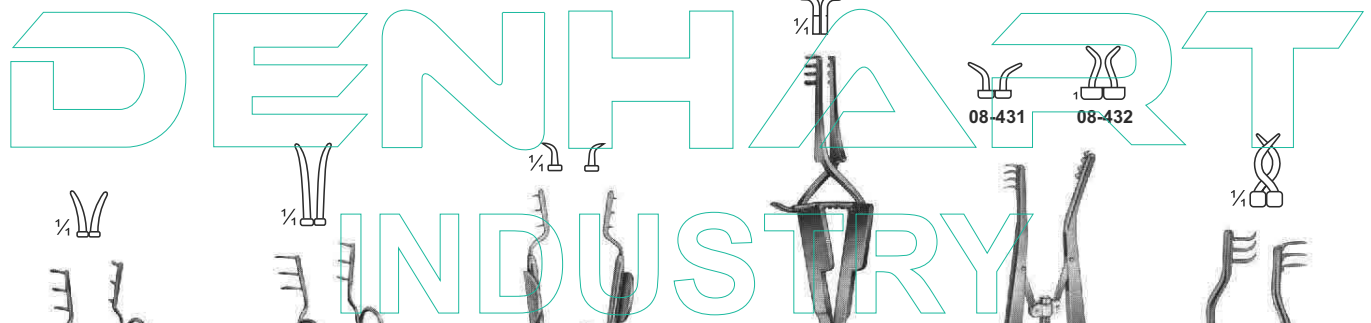

08-427
45 mm

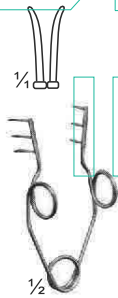

08-428
55 mm

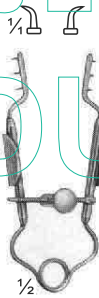

08-429
MUELLER
65 mm

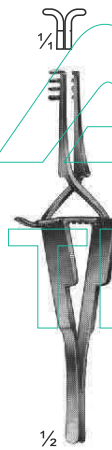

08-430
100 mm

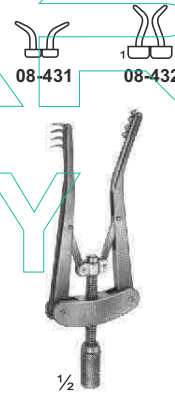

08-431 - 432
ALM
08-431 70 mm
08-432 100 mm

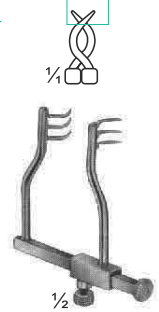

08-433
LOGAN
modif. REILL
50 mm

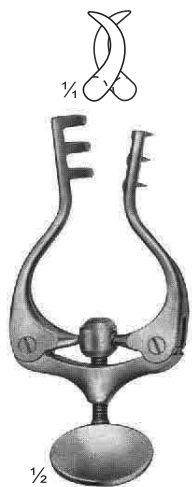

08-434
JANSEN
100 mm



08-435
JANSEN
100 mm

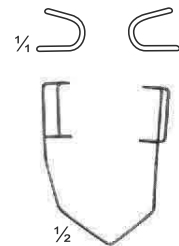

08-436
BARRAQUER
45 mm

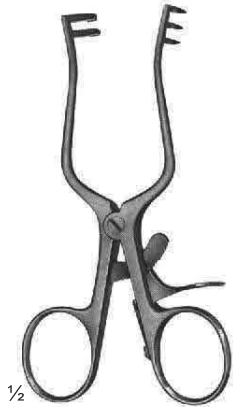

08-437
WEITLANER
Sharp
110 mm

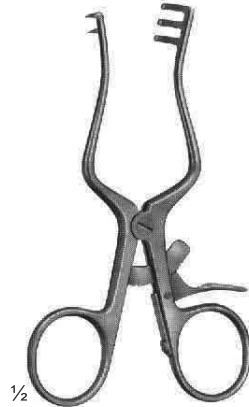

08-438
WEITLANER
Semi-Sharp
110 mm



08-439
WEITLANER
Blunt
110 mm

DENHART
INDUSTRY



08-440
WEITLANER
Sharp
130 mm

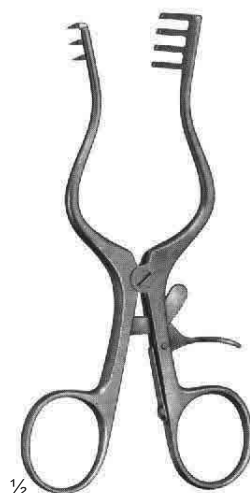

08-441
WEITLANER
Semi-Sharp
130 mm



08-442
WEITLANER
Blunt
130 mm

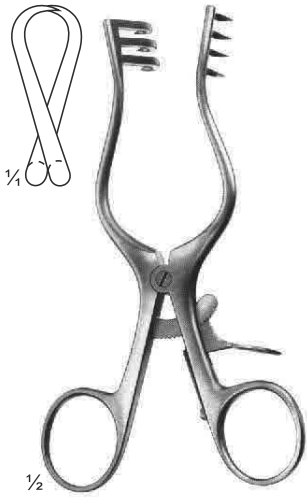

08-443
WEITLANER
Sharp
130 mm

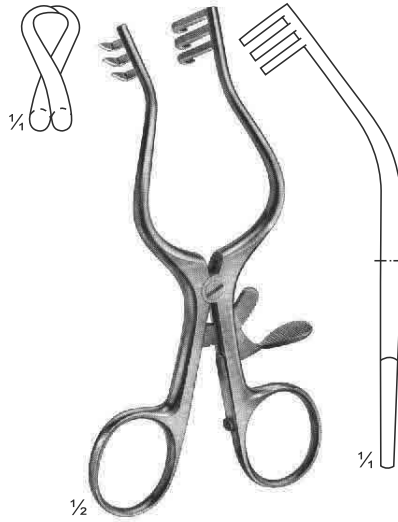

08-444
WULLSTEIN
Sharp
130 mm

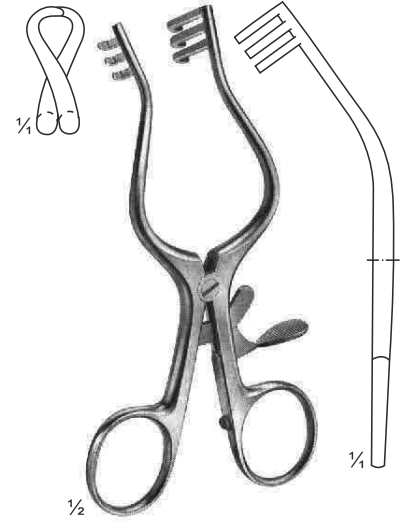

08-445
WULLSTEIN
Blunt
130 mm

DENHART

INDUSTRY



08-446
WEITLANER
Sharp
165 mm

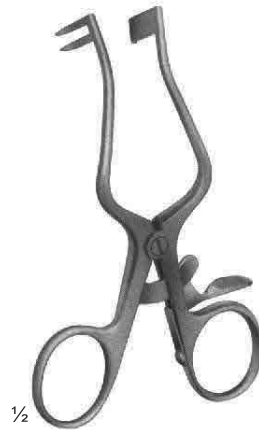
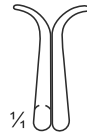

08-447
PLESTER
Blunt
110 mm



08-448
PERKINS
Blunt
130 mm

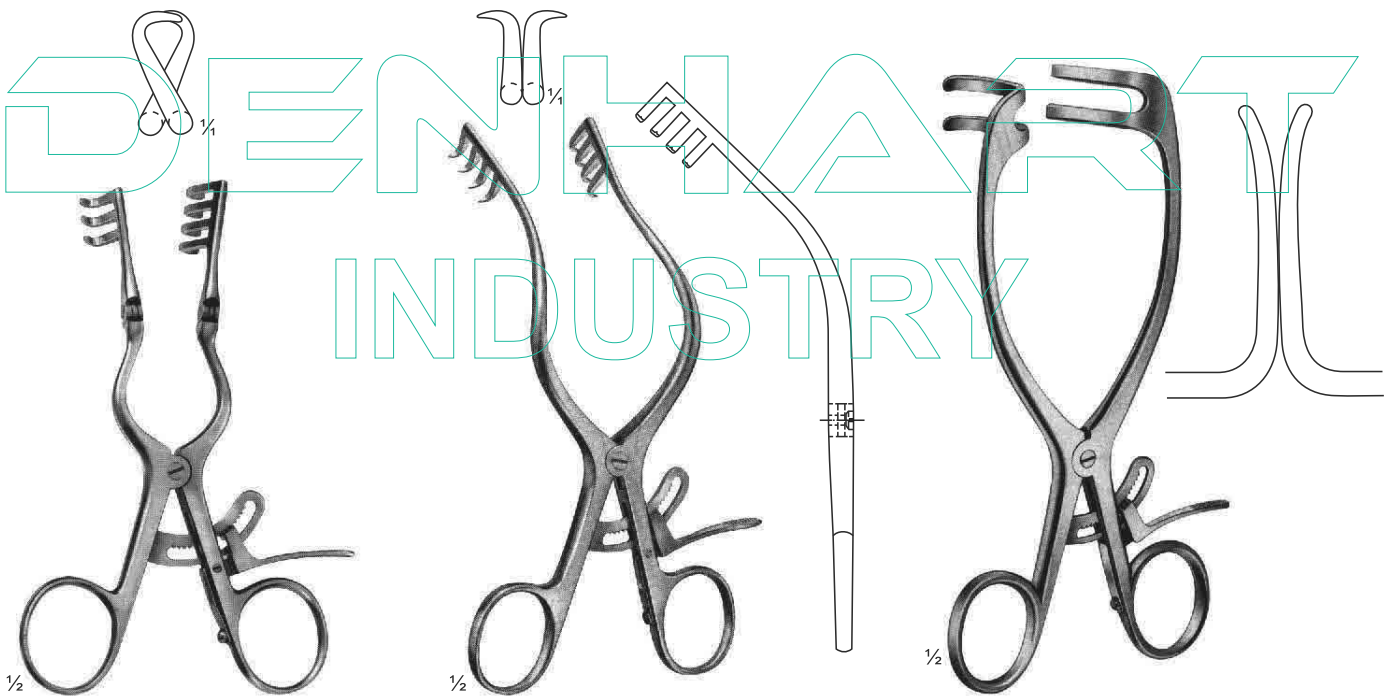

1/2

1/2

1/2

08-449
ADSON-BABY
Blunt
140 mm

08-450
MOLLISON
Sharp
155 mm

08-451
MAYO-ADAMS
165 mm

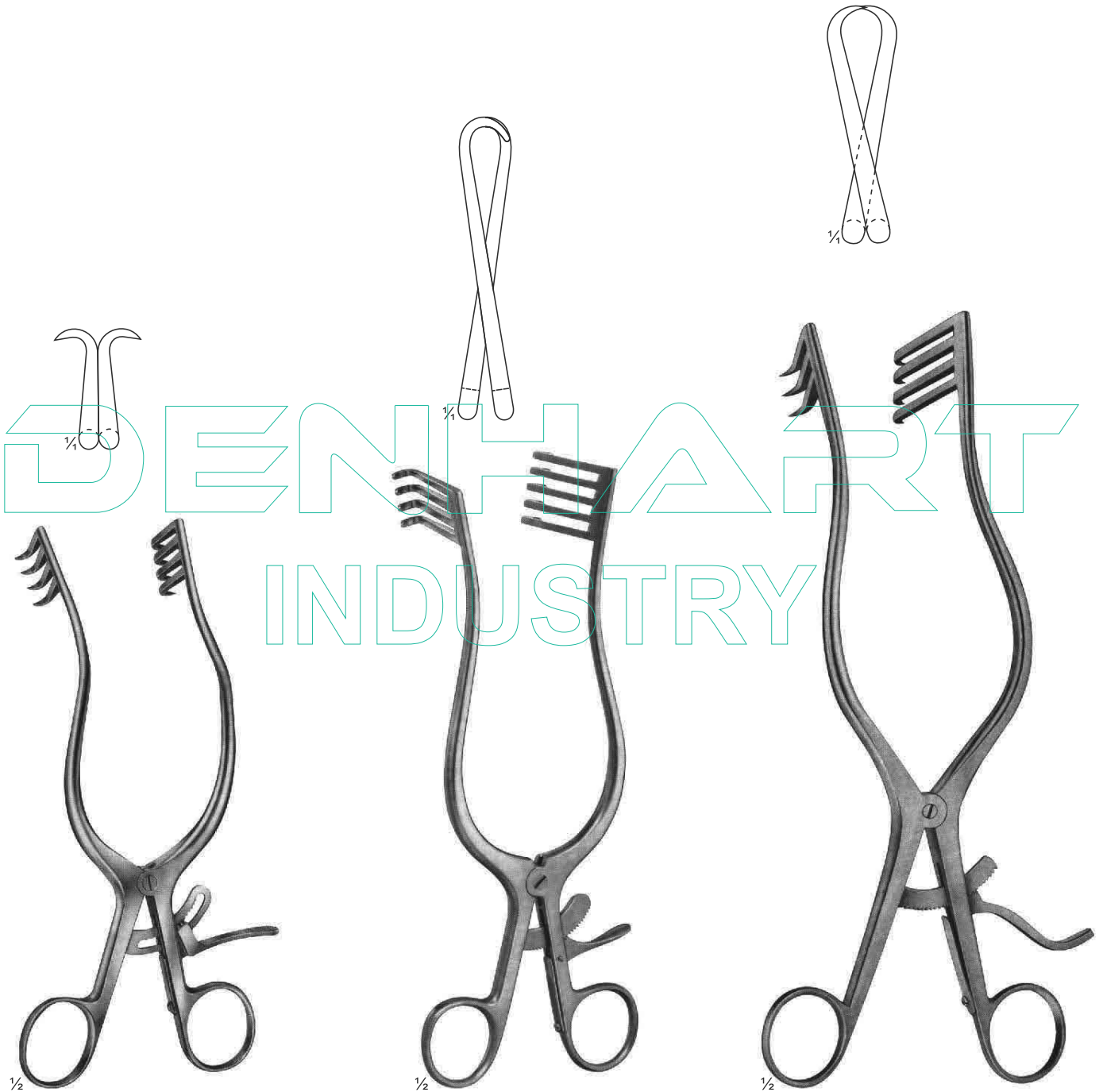

08-452
ANDERSON-ADSON
Sharp
190 mm

08-453
NORFOLK and
NORWICH
Blunt
220 mm

08-454
ADSON
Sharp
265 mm

Self-Retaining Laminectomy Retractors

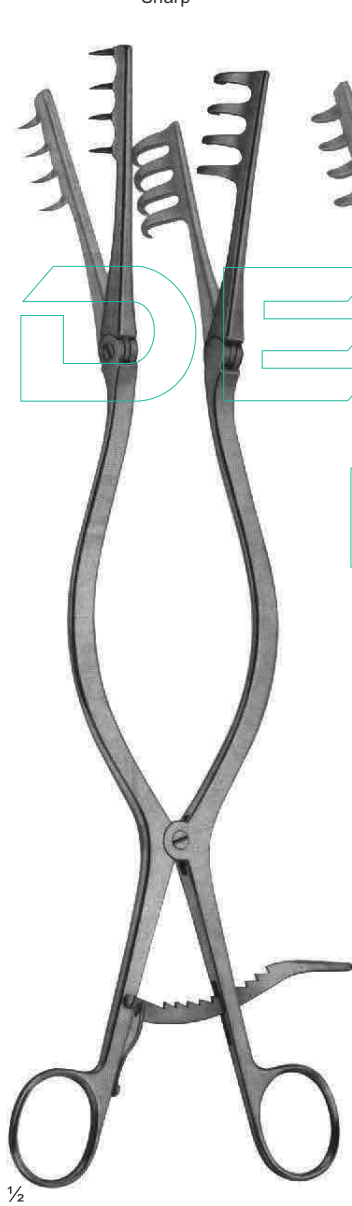
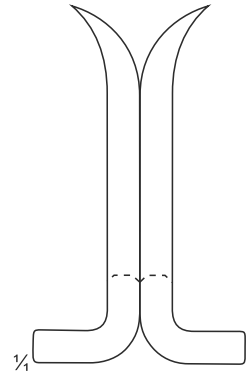
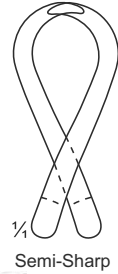
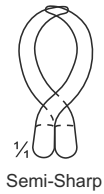
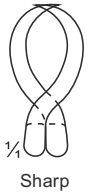

08-455 - 456
BECKMANN-ADSON
Sharp
310 mm

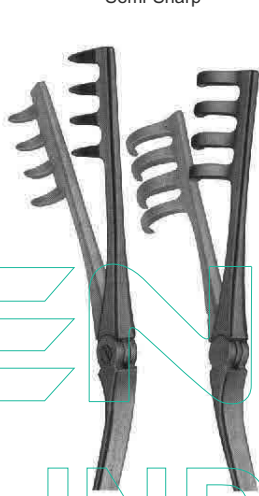

08-456
BECKMANN-ADSON
Semi-Sharp
310 mm

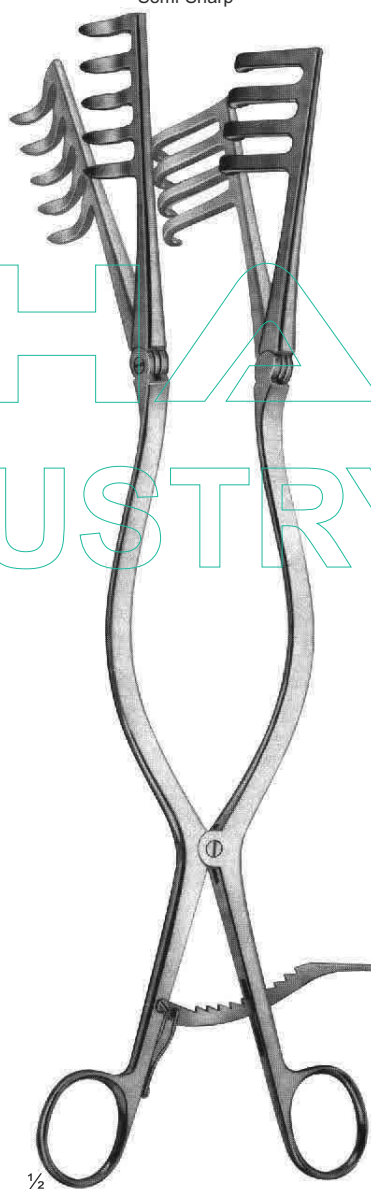

08-457
ADSON
Semi-Sharp
320 mm

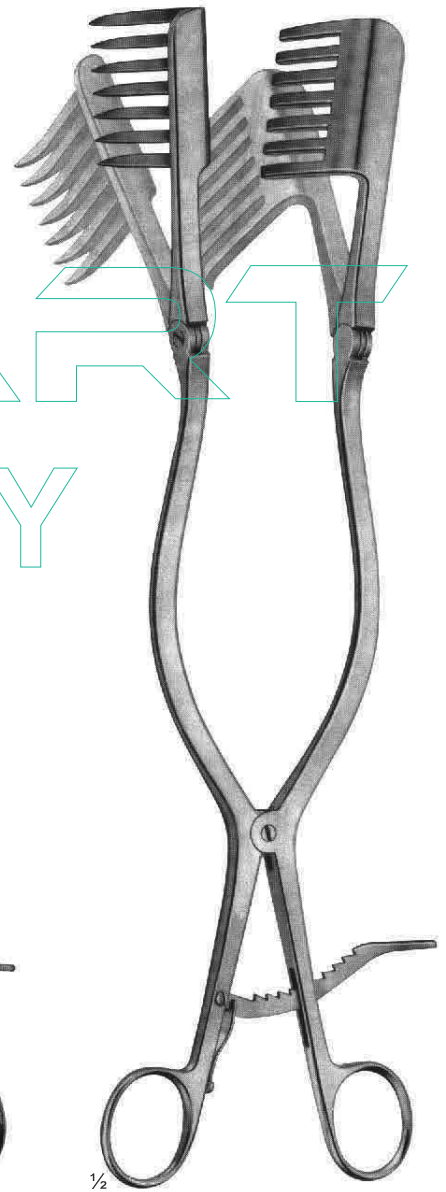

08-458
BECKMANN-EATON
Sharp
320 mm



$\frac{1}{2}$
08-459
JOLL (FRIEDMAN)
Thyroid- and Vaginal Retractor
155 mm

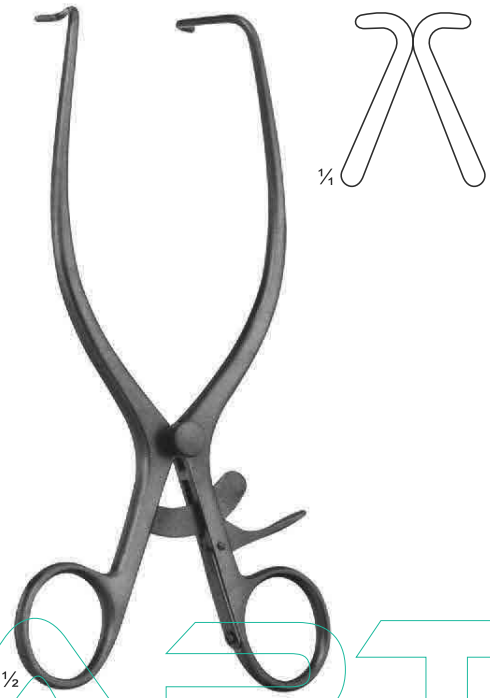

$\frac{1}{2}$
08-460
JACKSON BURROWS
Retractor, blunt
185 mm

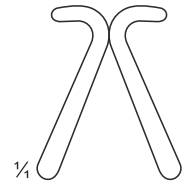

DENHART
INDUSTRY

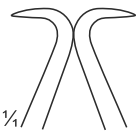

$\frac{1}{2}$
08-461
GELPI
Vaginal Retractor
135 mm



$\frac{1}{2}$
08-462
GELPI
Skin- and Vaginal Retractor
175 mm

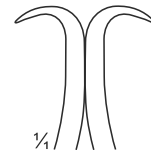

$\frac{1}{2}$
08-463
DE BAKEY
Femur Retractor
145 mm

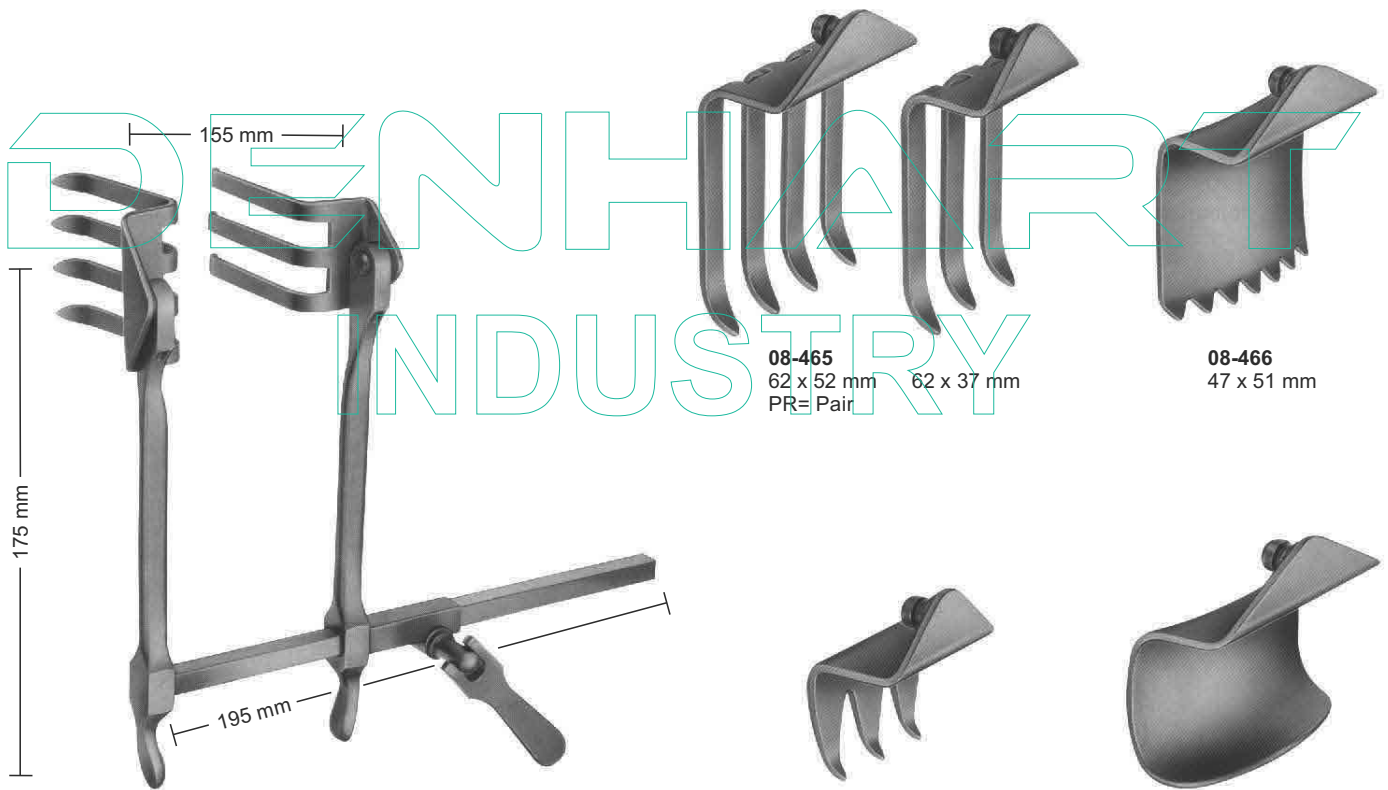

08-464 - 468
SCOVILLE-RICHTER
 Retractor with 1 pair
 blades reversible type.
 The Retractor bar and
 shanks may be easily
 rotated 180° when
 blades are in situ.

08-465
 62 x 52 mm 62 x 37 mm
 PR= Pair

08-466
 47 x 51 mm

08-467
 30 x 40 mm

08-468
 37 x 62 mm

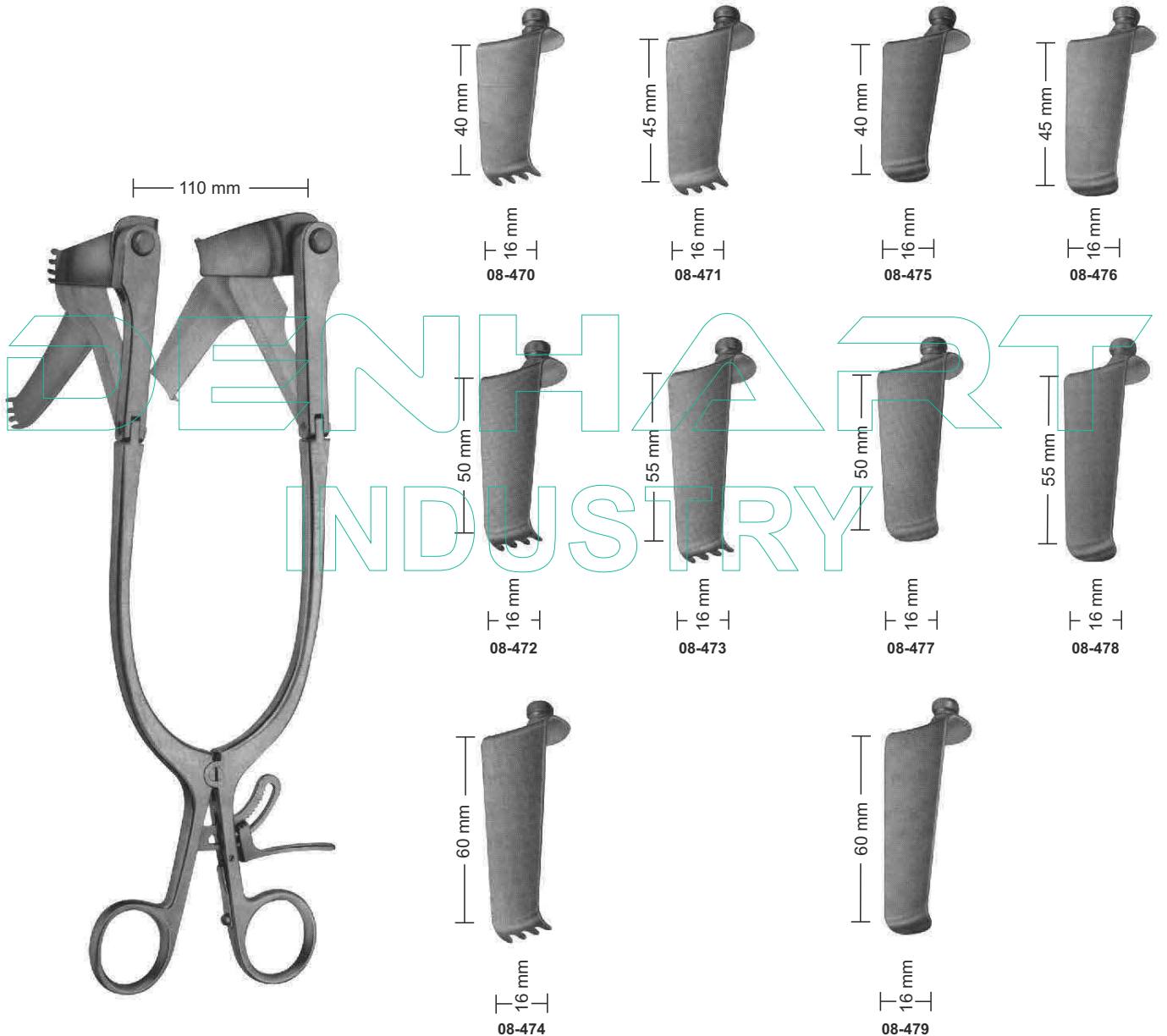

08-469
CLOWARD modif.
Spreader Only

08-470 blade
08-471 blade
08-472 blade
08-473 blade
08-474 blade

08-475 blade
08-476 blade
08-477 blade
08-478 blade
08-479 blade

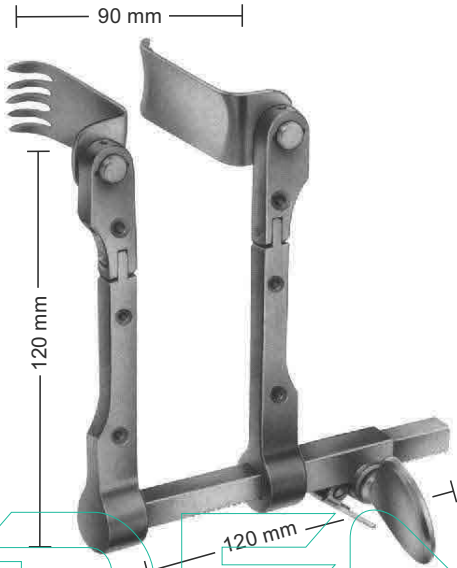

08-480
CASPAR
Retractor, adjustable,
consisting of: 5 medial
blades, 5 Lateral blades.

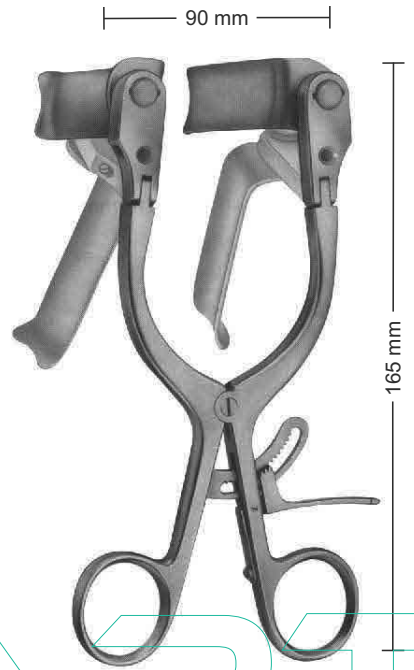

08-480 A
CASPAR
Counter retractor, adjustable,
consisting of: 5 blades.

DENHART
INDUSTRY



08-481 40 x 23 mm
08-482 45 x 23 mm
08-483 50 x 23 mm
08-484 55 x 23 mm
08-485 60 x 23 mm
Medial blades



08-486 40 x 23 mm
08-487 45 x 23 mm
08-488 50 x 23 mm
08-489 55 x 23 mm
08-490 60 x 23 mm
Lateral blades



08-491 45 x 23 mm
08-492 50 x 23 mm
08-493 55 x 23 mm
08-494 60 x 23 mm
08-495 65 x 23 mm
Blunt blades



08-496 50 x 25 mm
08-497 60 x 25 mm
Blunt blades,
for harvesting of the
iliac crest



08-498 40 x 25 mm
08-499 45 x 25 mm
08-500 50 x 25 mm
08-501 55 x 25 mm
08-502 60 x 25 mm
Medial Titan blades
semi transparent to x-ray



08-503 40 x 25 mm
08-504 45 x 25 mm
08-505 50 x 25 mm
08-506 55 x 25 mm
08-507 60 x 25 mm
Lateral Titan blades
semi transparent to x-ray

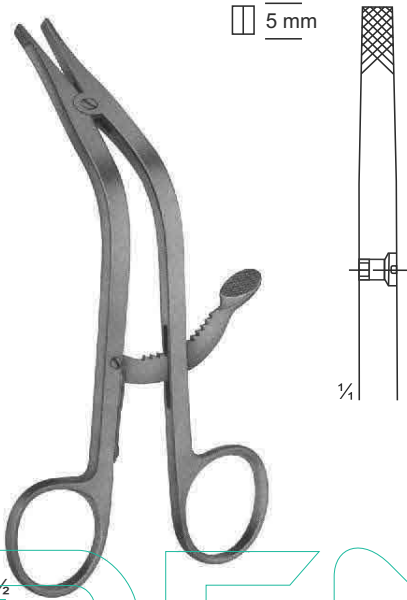

08-508
CLOWARD
155 mm



08-509
CLOWARD
135 mm

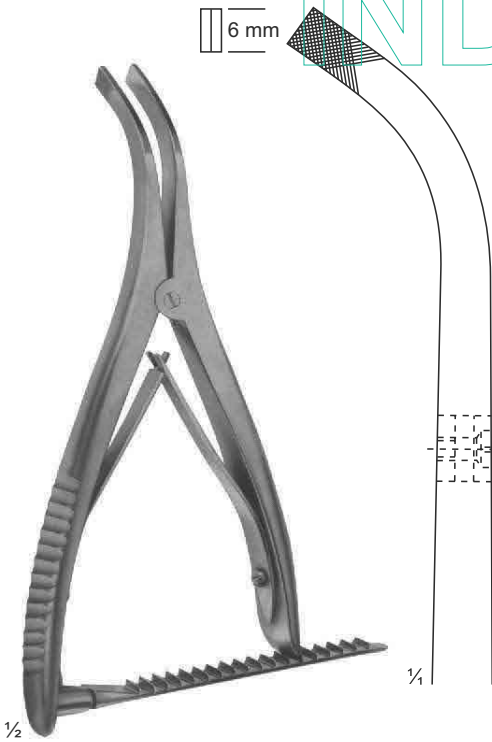

08-510
INGE
170 mm

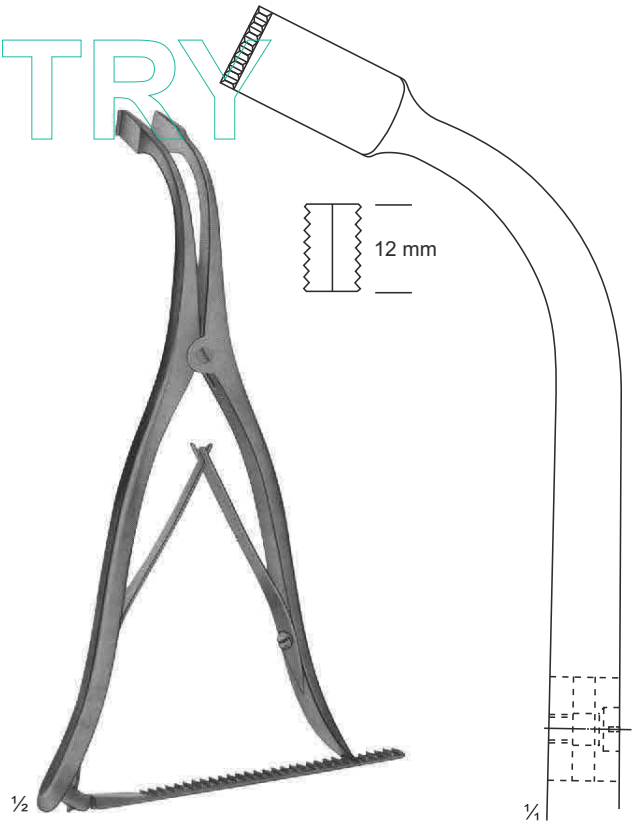

08-511
INGE
275 mm

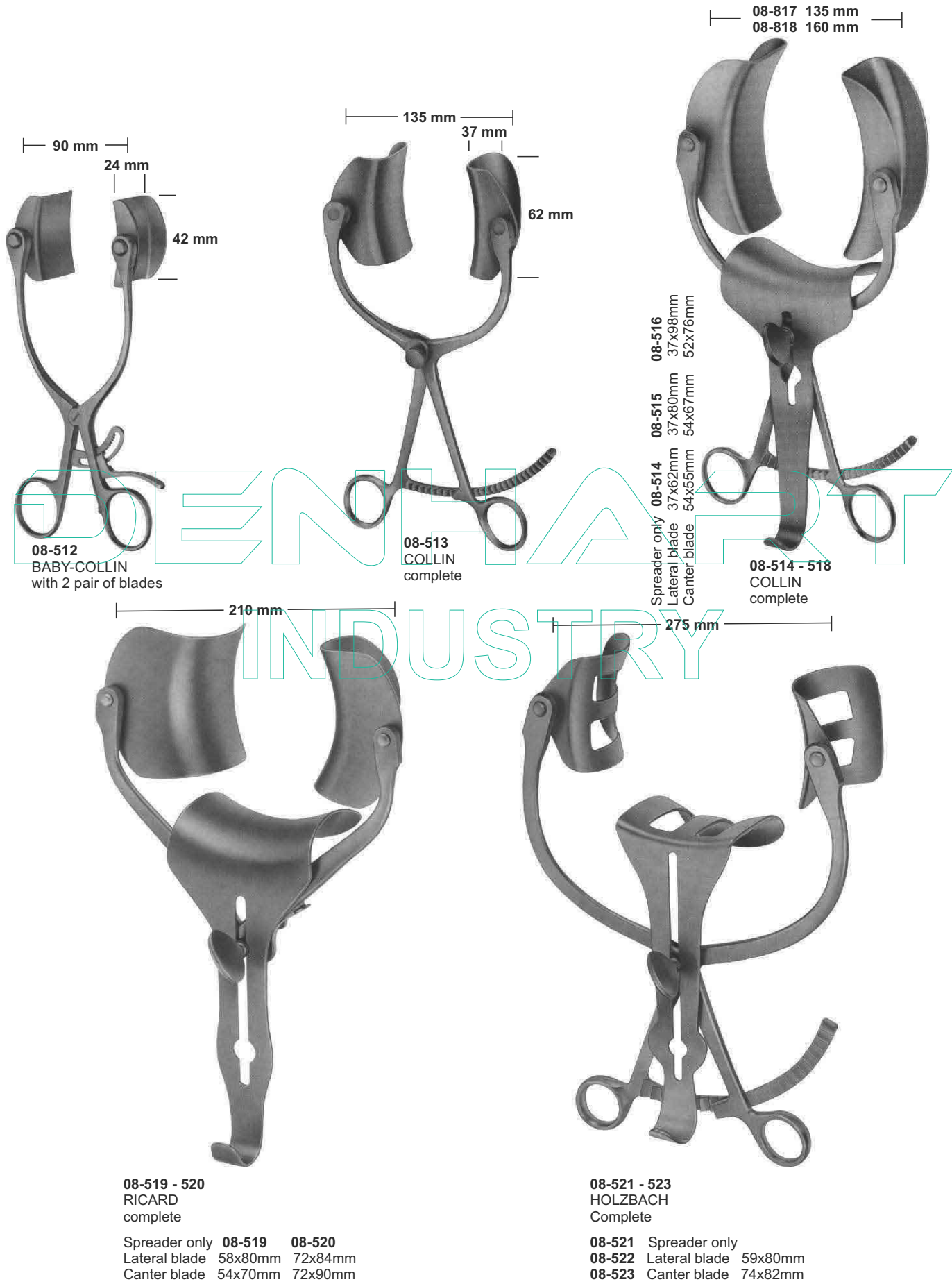

08-817 135 mm
08-818 160 mm

90 mm
24 mm
42 mm

135 mm
37 mm
62 mm

08-516
08-515
08-514
08-514
08-514

Spreader only 37x98mm
Lateral blade 37x80mm
Canter blade 54x67mm
Spreader only 37x62mm
Lateral blade 54x55mm
Canter blade 54x76mm

08-514 - 518
COLLIN
complete

08-512
BABY-COLLIN
with 2 pair of blades

08-513
COLLIN
complete

210 mm

275 mm

08-519 - 520
RICARD
complete

Spreader only 08-519 08-520
Lateral blade 58x80mm 72x84mm
Canter blade 54x70mm 72x90mm

08-521 - 523
HOLZBACH
Complete

08-521 Spreader only
08-522 Lateral blade 59x80mm
08-523 Canter blade 74x82mm

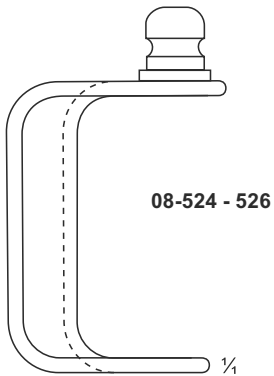

Lateral blades only
08-524 37x62 mm
08-525 37x80 mm
08-526 37x98 mm

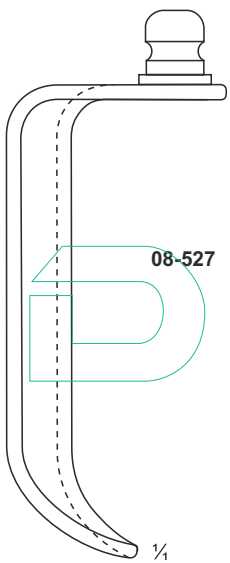

08-527 61x80 mm

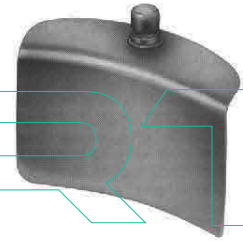

DENHART
INDUSTRY

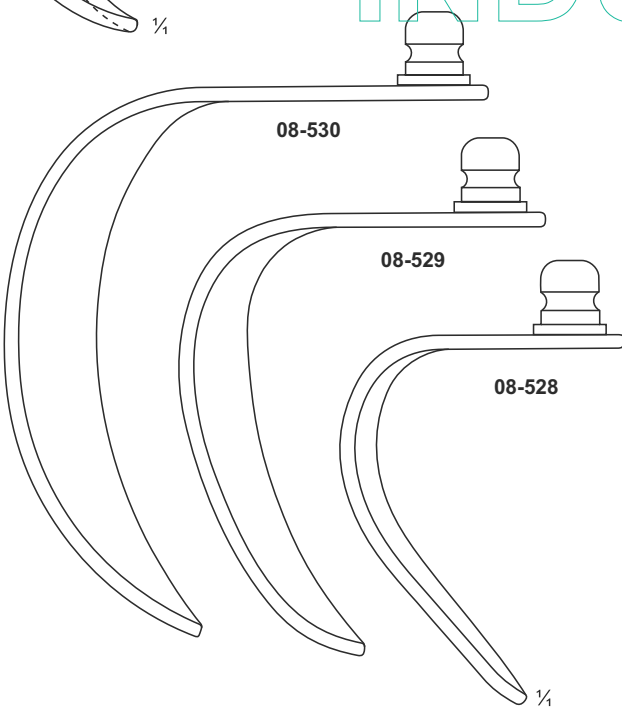

08-528 48x59 mm
 08-529 58x80 mm
 08-530 72x84 mm

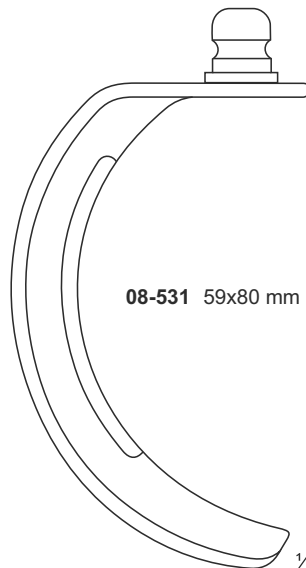



08-532
GOSSET
Blades: 38 mm deep

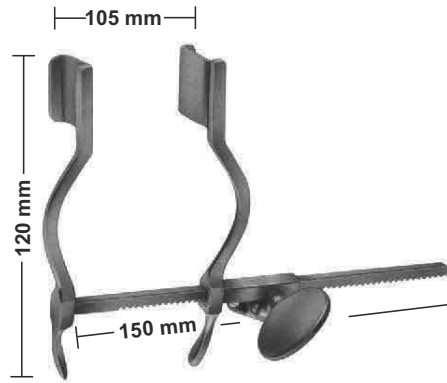

08-533
HERTZLER
Blades 20 X 25 mm

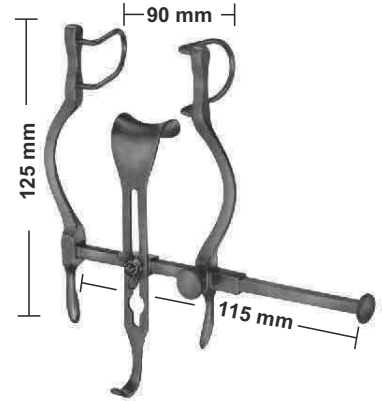

08-534
BALFOUR-BABY
Lateral blades 27 mm deep
Center blade 21x24 mm

DENHART INDUSTRY

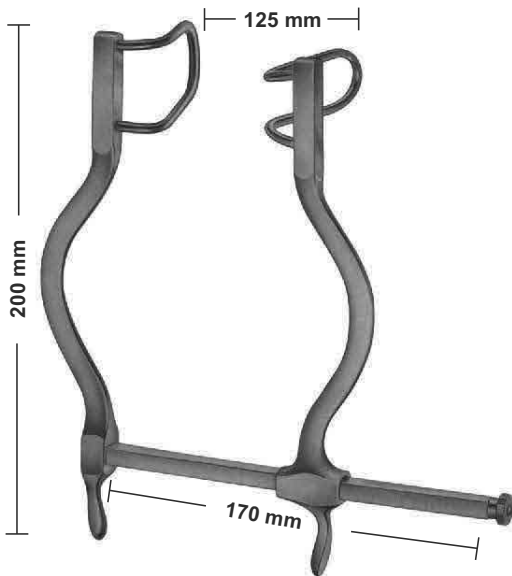

08-535
GOSSET
Blades: 55 mm deep

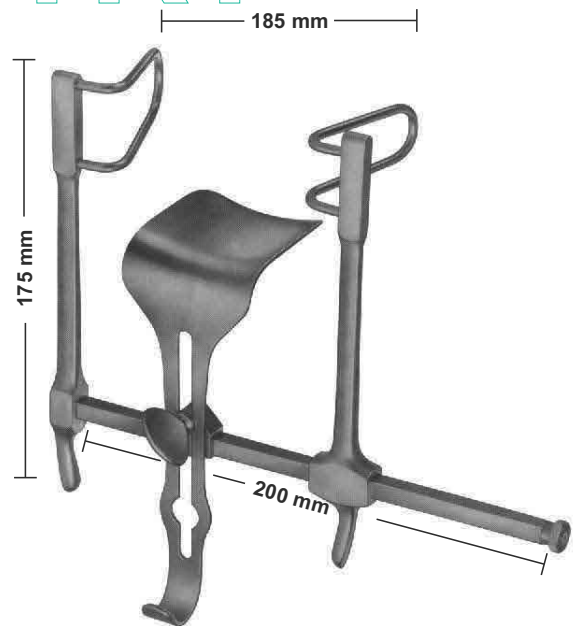

08-536
GOSSET
Lateral blades 58 mm deep
Center blade 59 x 57 mm

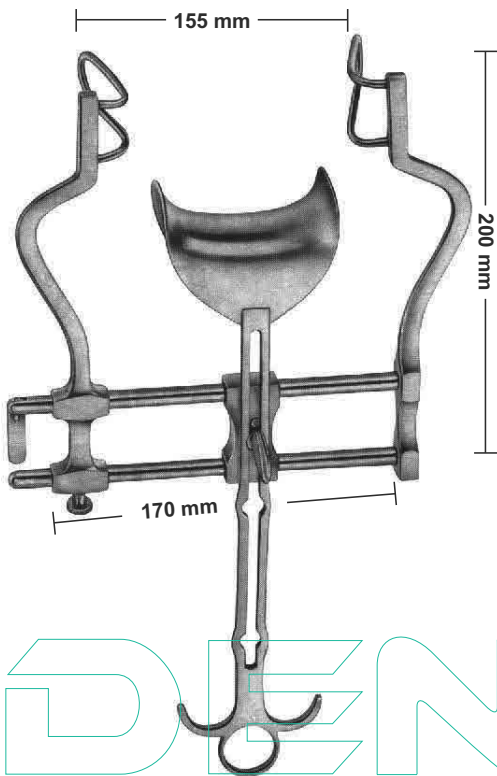

08-537
BALFOUR
Lateral blades 60 mm deep
Center blade 47 x 80 mm

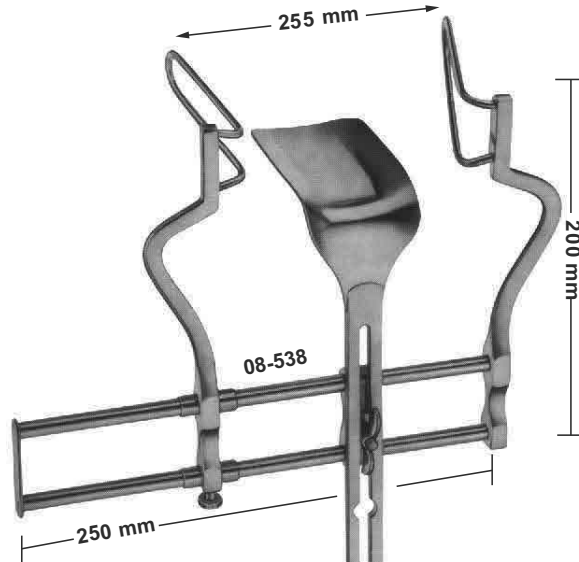

08-538
BALFOUR
Lateral blades 105 mm deep
Center blade 107 x 59 mm

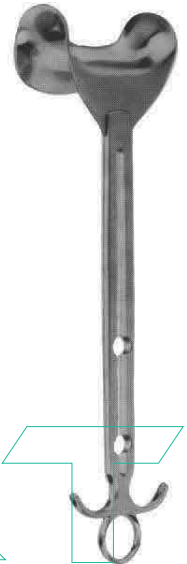

08-539
Center blade only
54x80 mm

DENHART INDUSTRY

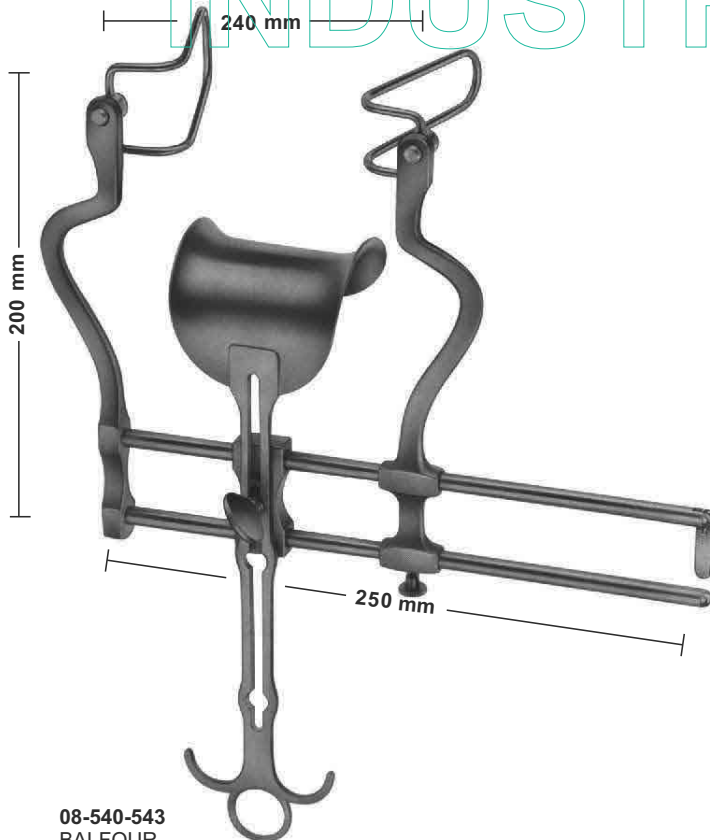

08-540-543 BALFOUR Spreader only	08-540 Lateral blades 50 mm Center blade 47 x 80 mm	08-541 Lateral blades 60 mm Center blade 62x76 mm	08-542 Lateral blades 75 mm Center blade 80x80 mm	08-543 Lateral blades 90 mm Center blade 80x80 mm
---	--	--	--	--



Lateral blades
08-544 50 mm deep
08-545 60 mm deep
08-546 75 mm deep
08-547 90 mm deep
 Sales Unit of blades: PR = pair

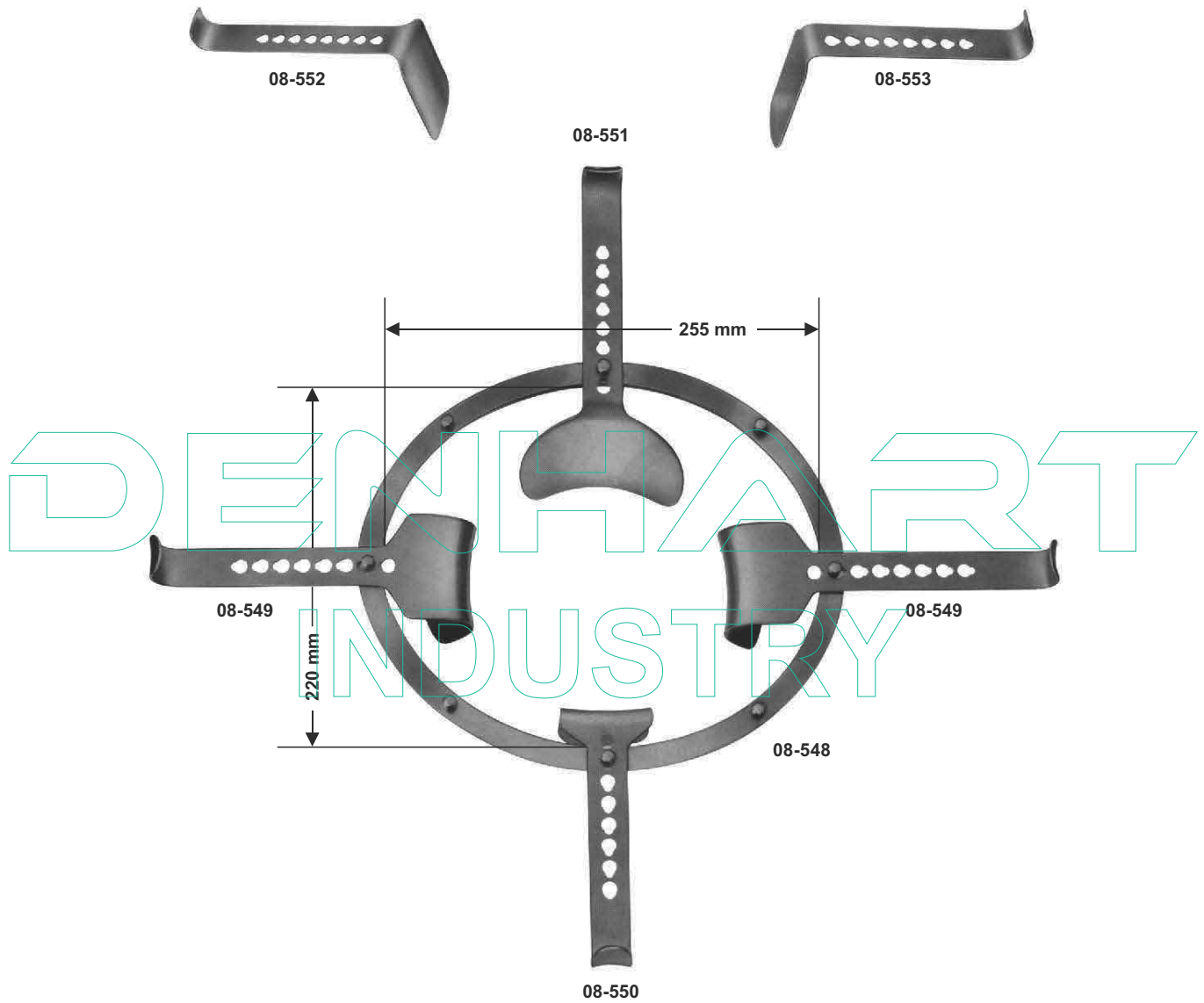

08-548 - 08-553

SEMM

consisting of:

- 08-548** 1 frame 225 x 220 mm
- 08-549** 2 blades 46 x 64 mm
- 08-550** 1 blade 53 x 54 mm
(for bladder)
- 08-551** 1 blade 82 x 97 mm
(for intestine)
- 08-552** 1 blade 98 x 51 mm
(for intestine)
- 08-553** 1 blade, narrow
107 x 36 mm

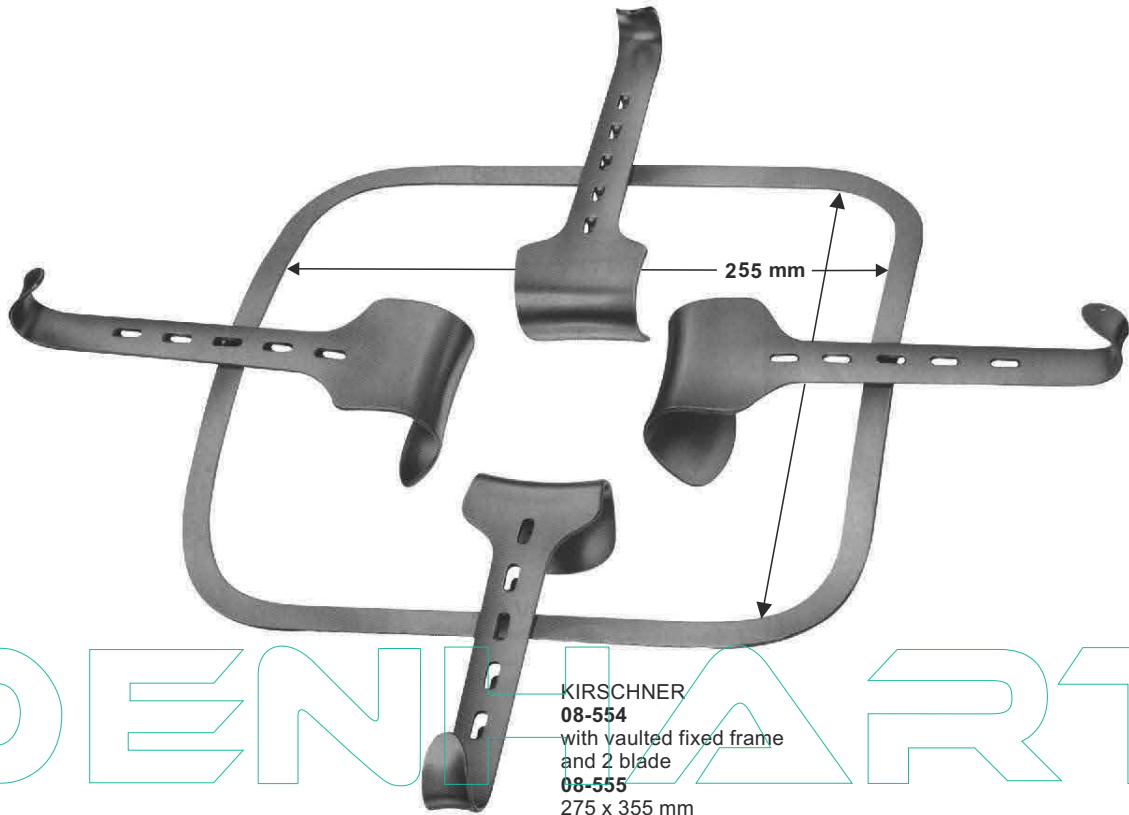

DENHART
INDUSTRY

KIRSCHNER
08-554
with vaulted fixed frame
and 2 blade
08-555
275 x 355 mm
Frame only, over-sized
08-556
295 x 275 mm
Frame only



08-557
KIRSCHNER
64 x 80 mm



08-558
KIRSCHNER-BALFOUR
80x 82 mm



08-559 - 561
KIRSCHNER
08-559 90x 69mm
08-560 92x 95mm
08-561 78x 58mm



08-562 - 564
KIRSCHNER
08-562 108x42mm
08-563 91x 55mm
08-564 121x 55mm

Intestinal and Tissue Grasping Forceps

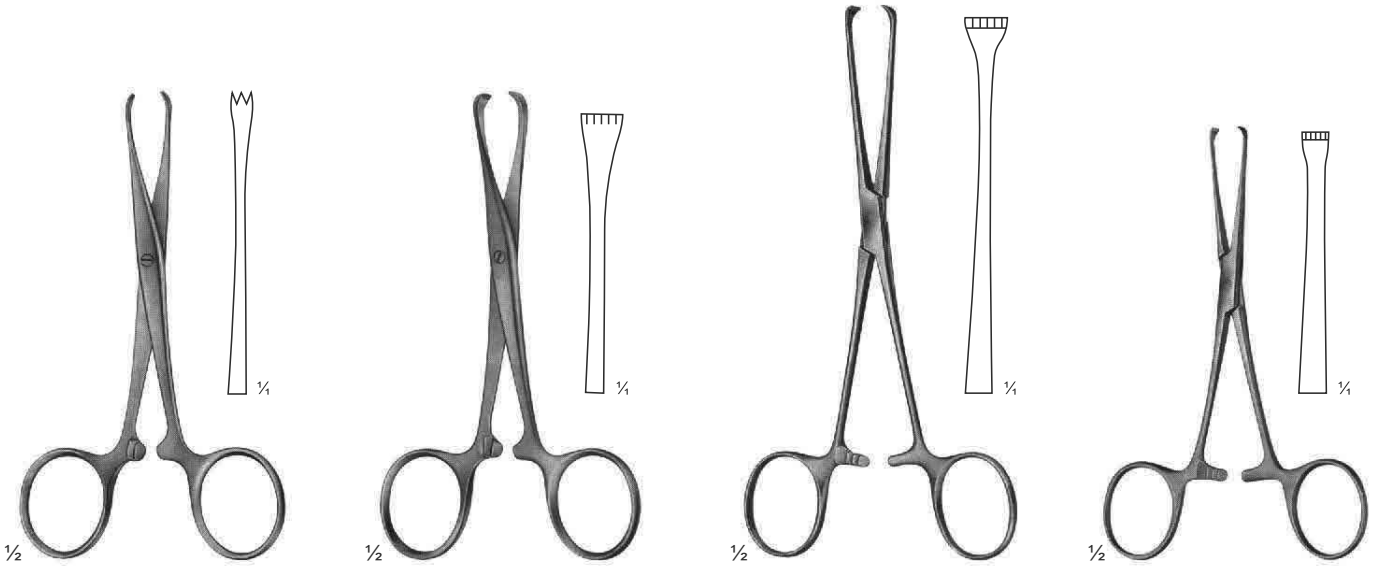

09-101
CHAPUT
2 X 3 teeth, sharp
125 mm,

09-102
TUFFIER
5 X 6 teeth, sharp
125 mm,

09-103
BOYS-ALLIS
5 X 6 teeth, sharp
155 mm,

09-104
ALLIS
4 X 5 teeth
155 mm,

DENHART
INDUSTRY

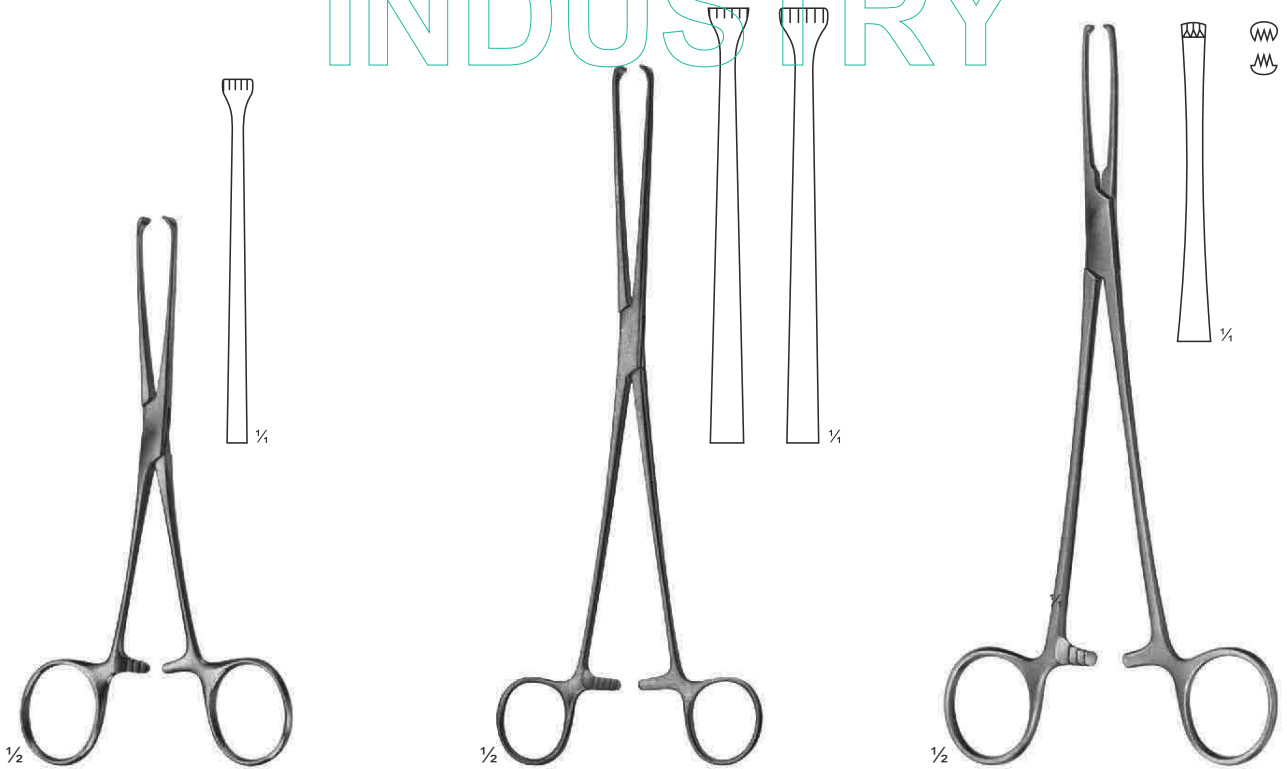

09-105
ALLIS
155 mm,
4 X 5 teeth

09-106
ALLIS
190 mm,
09-107
255 mm,
5 X 6 teeth

09-108
JUDD-ALLIS
3 X 4 teeth
195 mm,



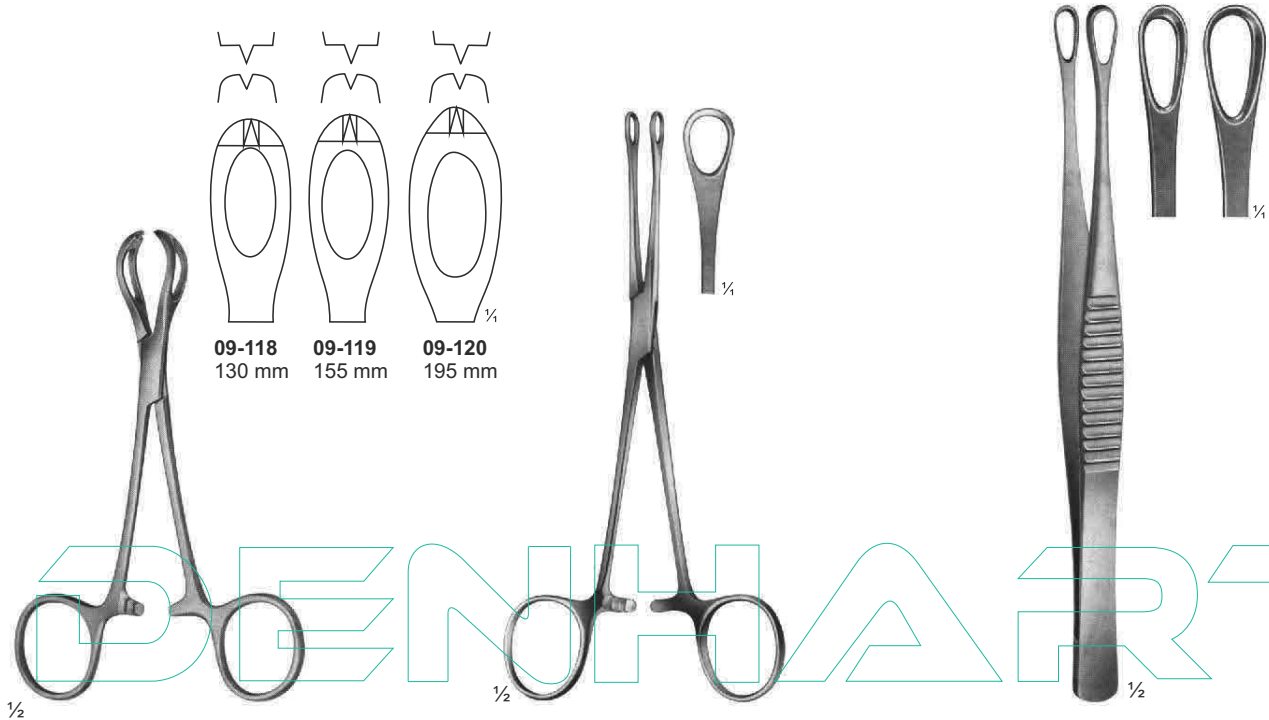

09-118-120
LANE

09-121
WILLIAMS
160 mm

09-122
DENIS
BROWNE
190 mm

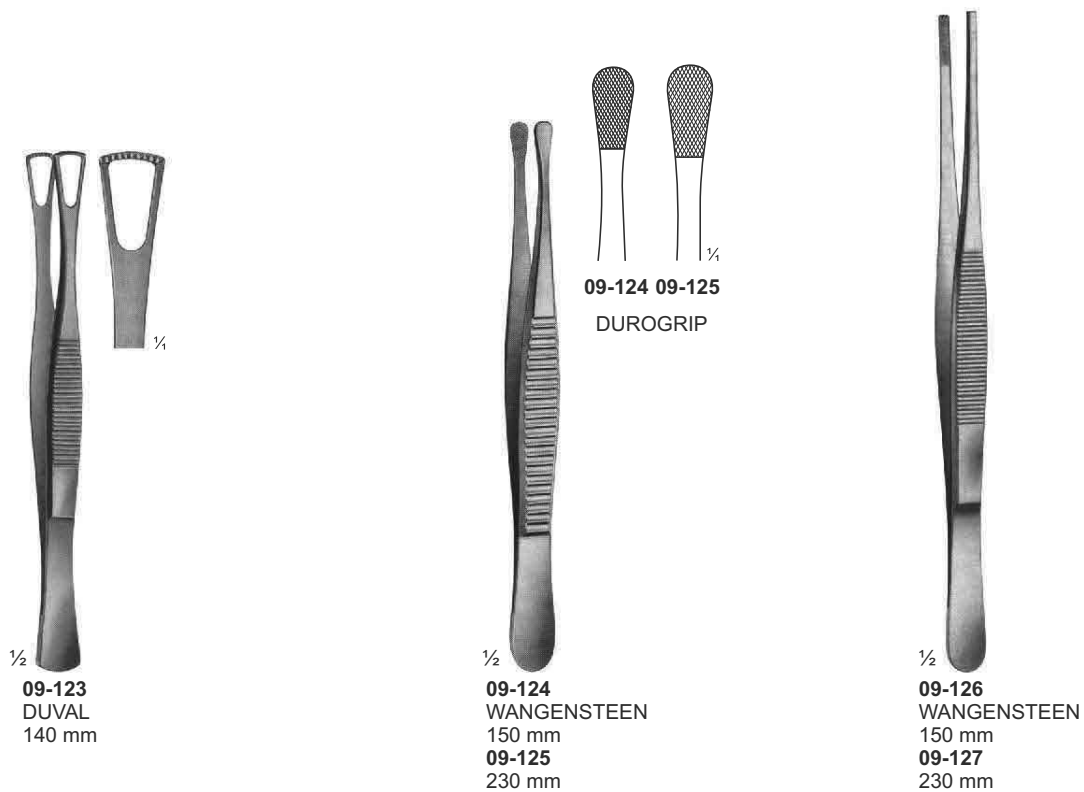

09-123
DUVAL
140 mm

09-124
WANGENSTEEN
150 mm
09-125
230 mm

09-126
WANGENSTEEN
150 mm
09-127
230 mm

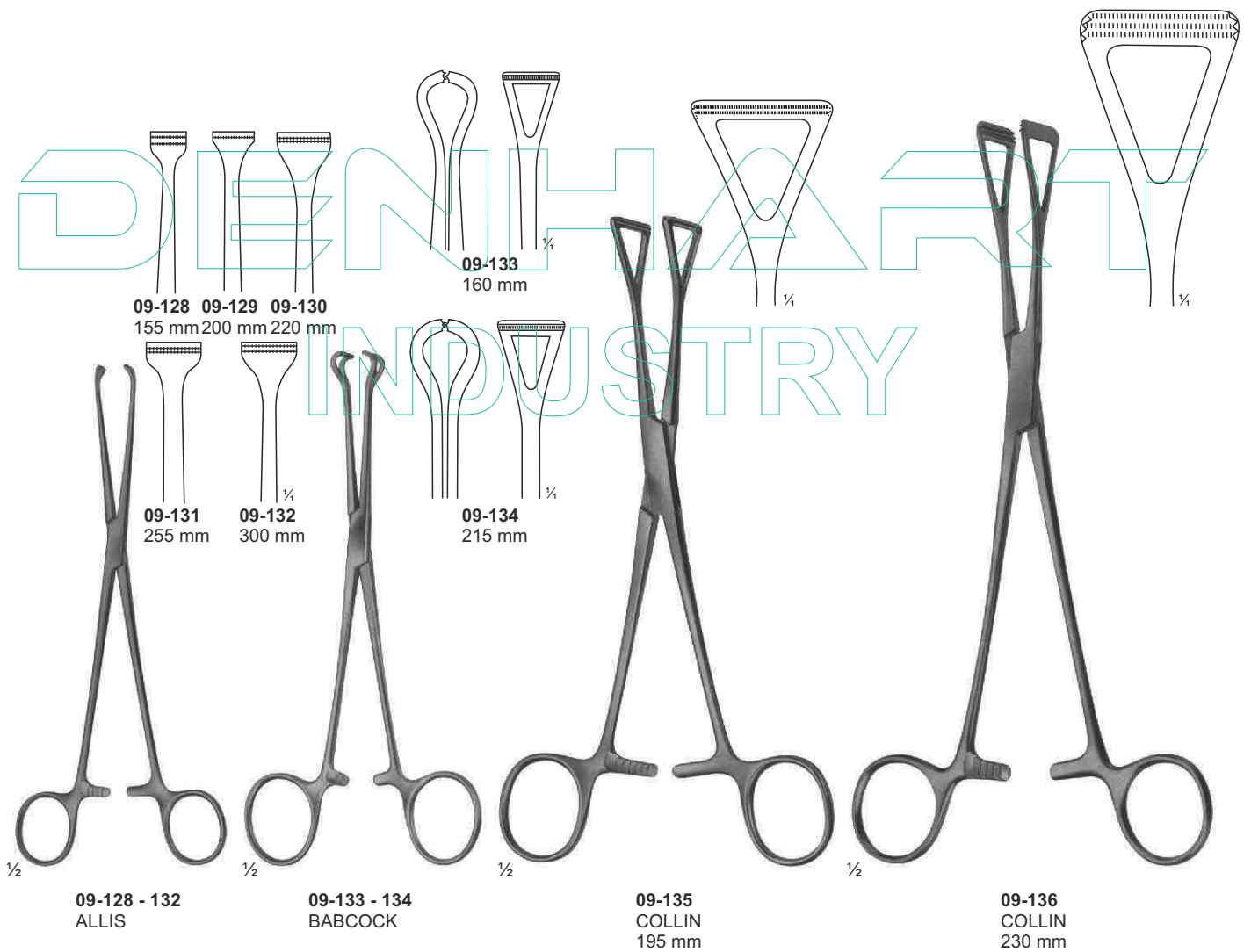

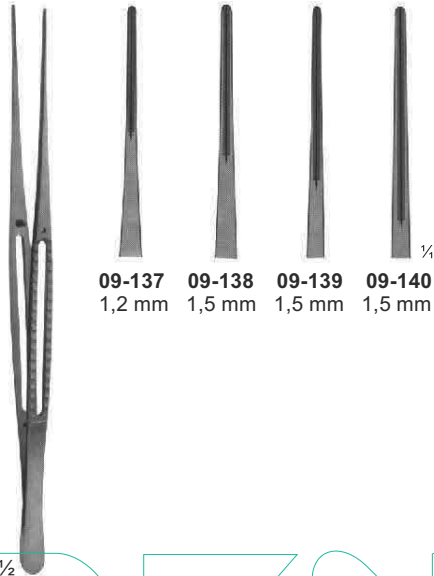

09-137 1,2 mm
09-138 1,5 mm
09-139 1,5 mm
09-140 1,5 mm

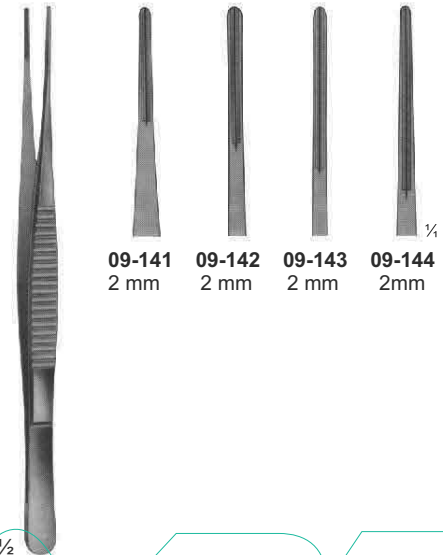

09-141 2 mm
09-142 2 mm
09-143 2 mm
09-144 2mm

1/2
09-137 150 mm
09-138 200 mm
09-139 240 mm
09-140 300 mm

1/2
DE-BAKEY
09-141 150 mm
09-142 200 mm
09-143 240 mm
09-144 300 mm

INDUSTRY

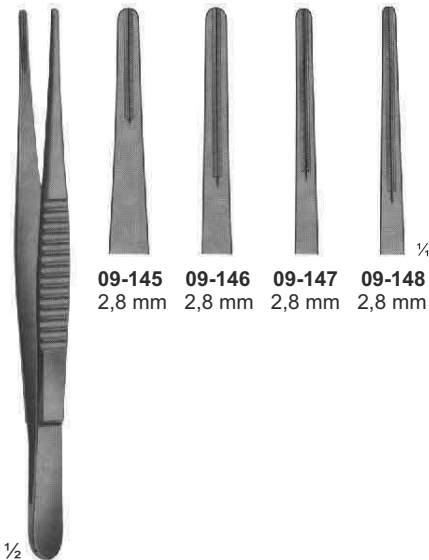

09-145 2,8 mm
09-146 2,8 mm
09-147 2,8 mm
09-148 2,8 mm

1/2
DE BAKEY
09-145 150 mm
09-146 200 mm
09-147 240 mm
09-148 300 mm

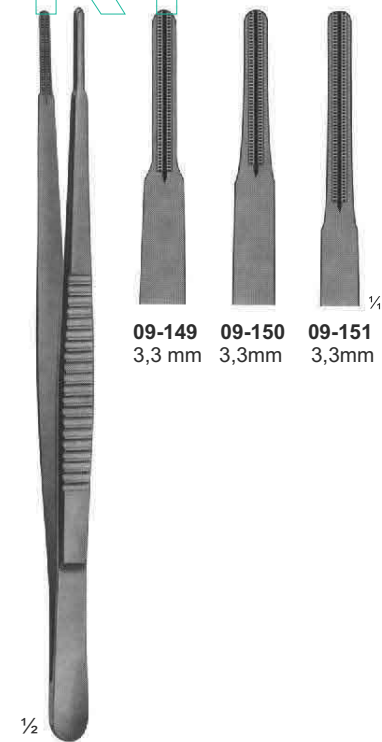

09-149 3,3 mm
09-150 3,3mm
09-151 3,3mm

1/2
DE BAKEY
09-149 200 mm
09-150 240 mm
09-151 300 mm

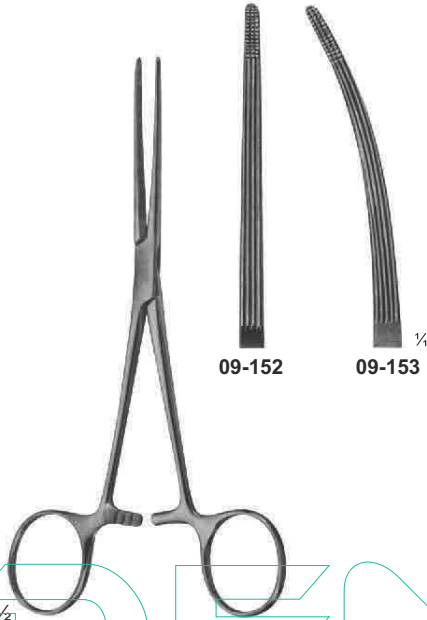
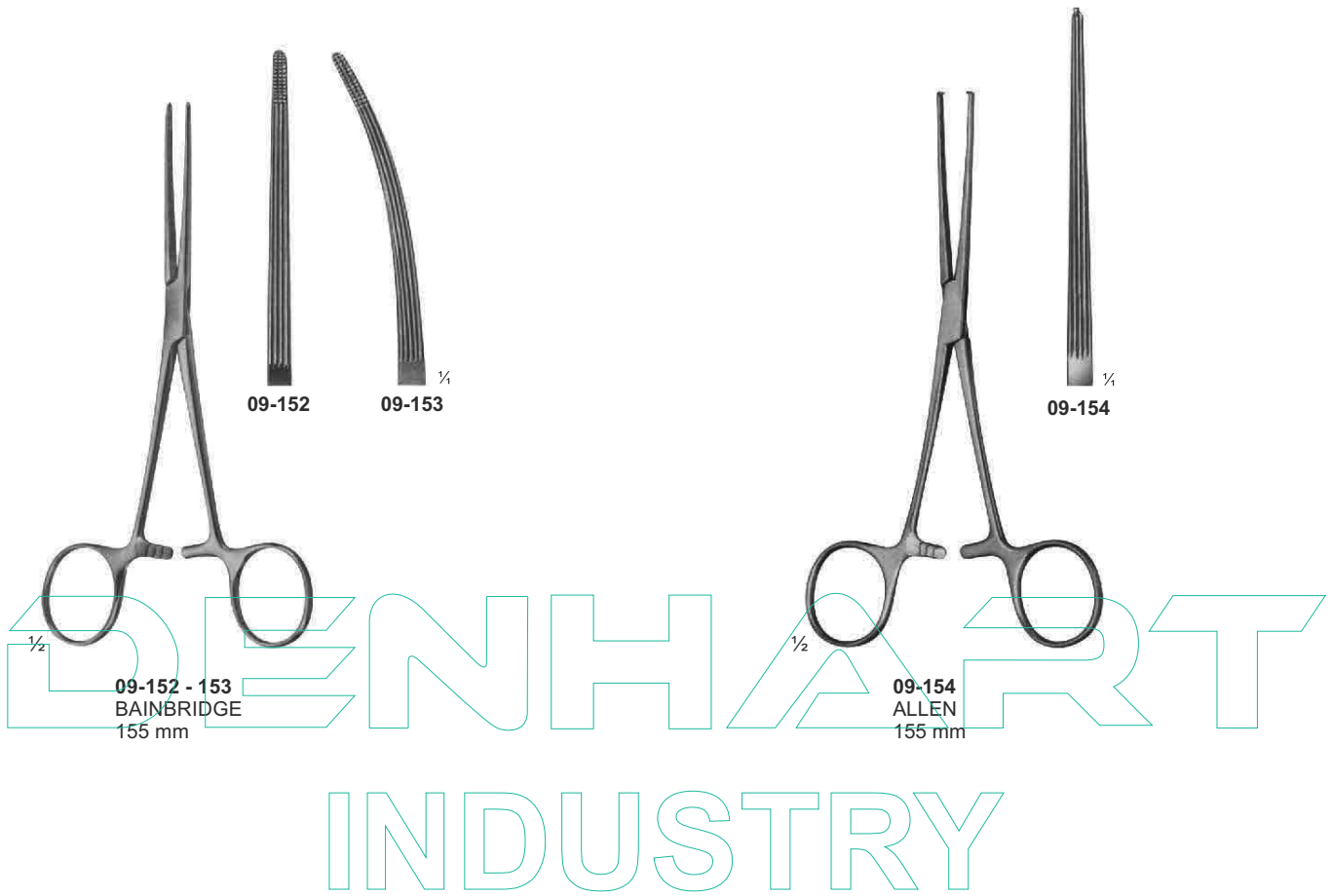

09-152

09-153 $\frac{1}{4}$

$\frac{1}{2}$
09-152 - 153
BAINBRIDGE
155 mm

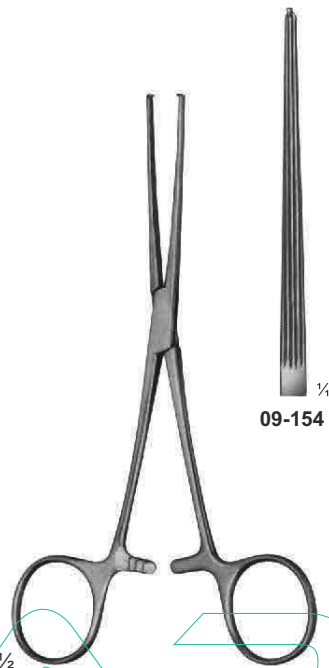

09-154 $\frac{1}{4}$

$\frac{1}{2}$
09-154
ALLEN
155 mm



09-155

09-156 $\frac{1}{4}$

$\frac{1}{2}$
09-155 - 156
BABY-KOCHER
very elastic blades
130 mm

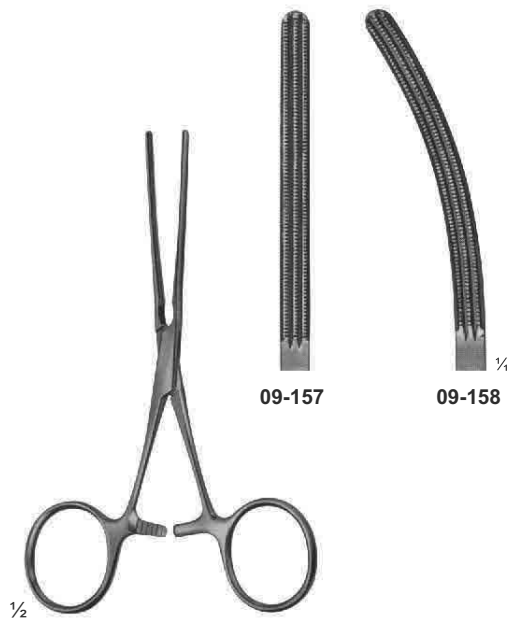

09-157

09-158 $\frac{1}{4}$

$\frac{1}{2}$
09-157 - 158
BABY-KOCHER
with elastic blades
130 mm

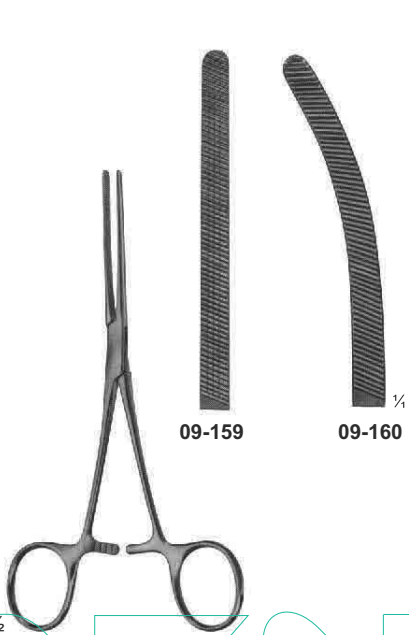

09-159

09-160 $\frac{1}{4}$

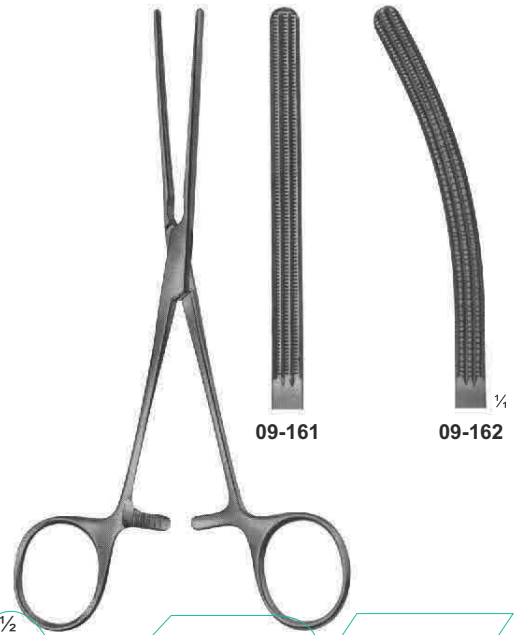

09-161

09-162 $\frac{1}{4}$

DENHART
INDUSTRY

$\frac{1}{2}$
09-159 - 160
DOYEN
elastic
165 mm

$\frac{1}{2}$
09-161 - 162
DOYEN
with elastic blades
170 mm

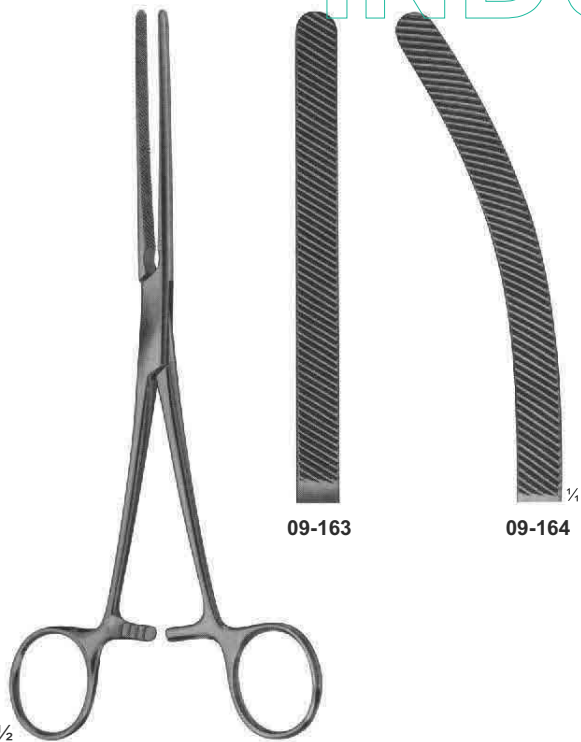

09-163

09-164 $\frac{1}{4}$

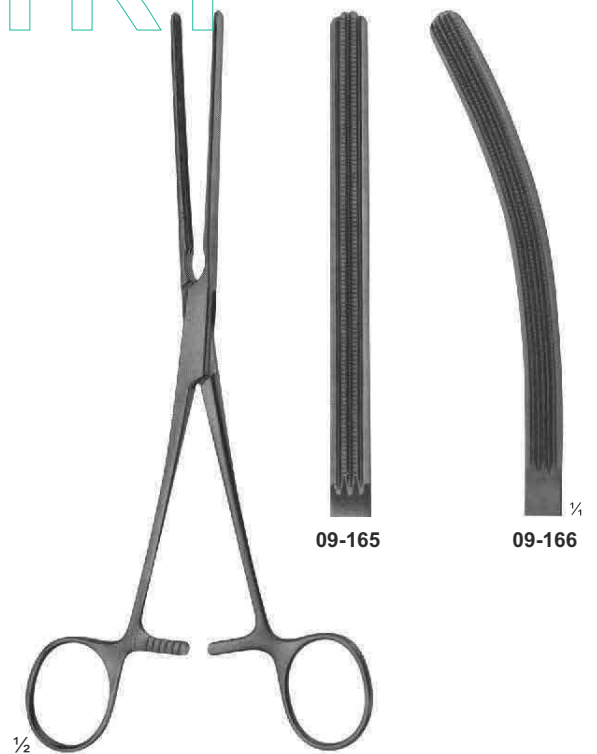

09-165

09-166 $\frac{1}{4}$

$\frac{1}{2}$
09-163 - 164
HARTMANN
with elastic blades
200 mm

$\frac{1}{2}$
09-165 - 166
HARTMANN
with elastic blades
200 mm

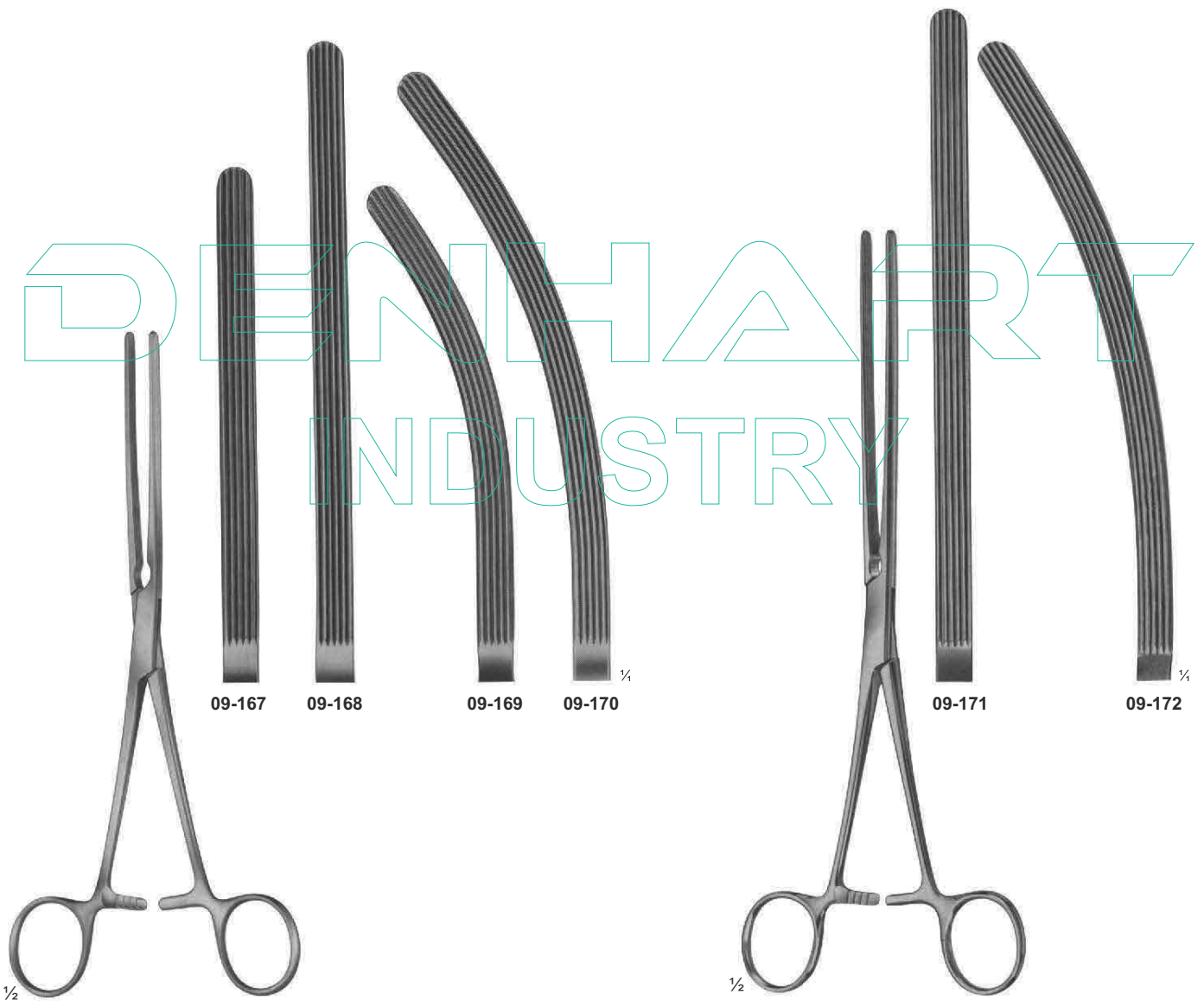

09-167

09-168

09-169

09-170 $\frac{1}{4}$

09-171

09-172 $\frac{1}{4}$

$\frac{1}{2}$

09-167 - 170
KOCHER
with elastic blades
09-169 210 mm
09-170 230 mm

$\frac{1}{2}$

09-171 - 172
DOYEN
with elastic blades
210 mm

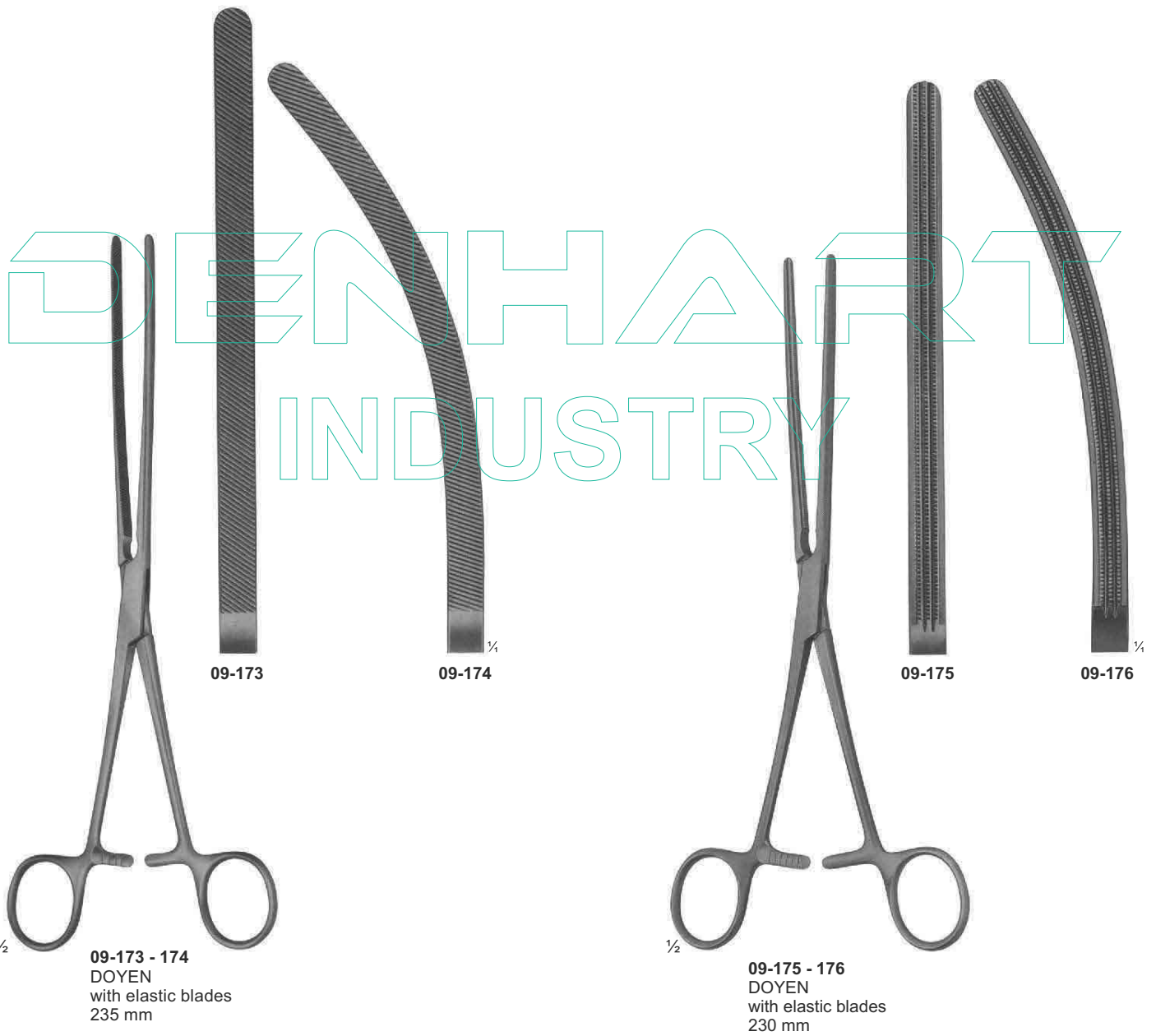

$\frac{1}{2}$
09-173 - 174
DOYEN
with elastic blades
235 mm

$\frac{1}{2}$
09-175 - 176
DOYEN
with elastic blades
230 mm

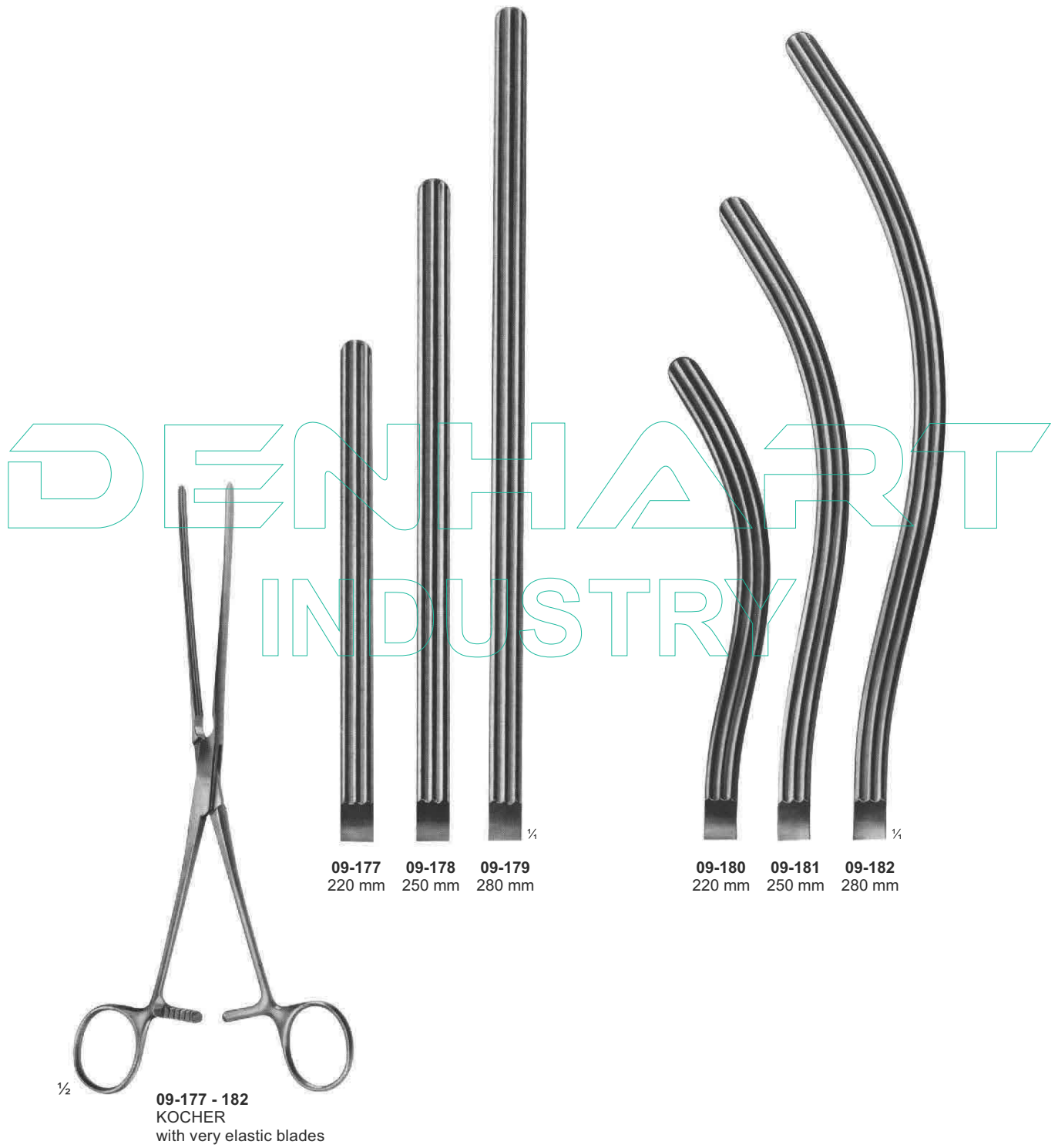

DENHART
INDUSTRY

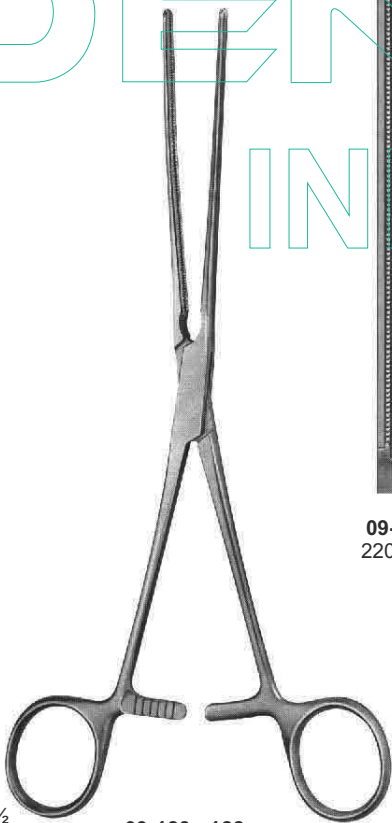

½

09-183 - 188
KOCHER
with very elastic blades

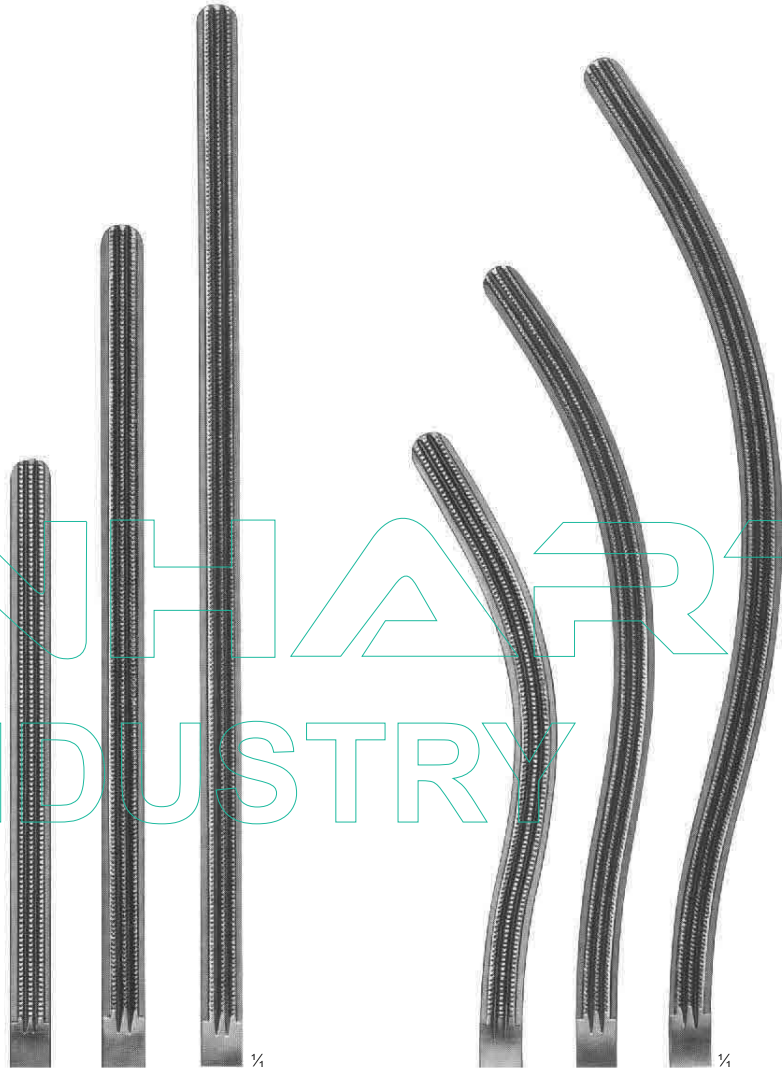

09-183 220 mm
09-184 250 mm
09-185 280 mm

¼

09-186 220 mm
09-187 250 mm
09-188 280 mm

¼

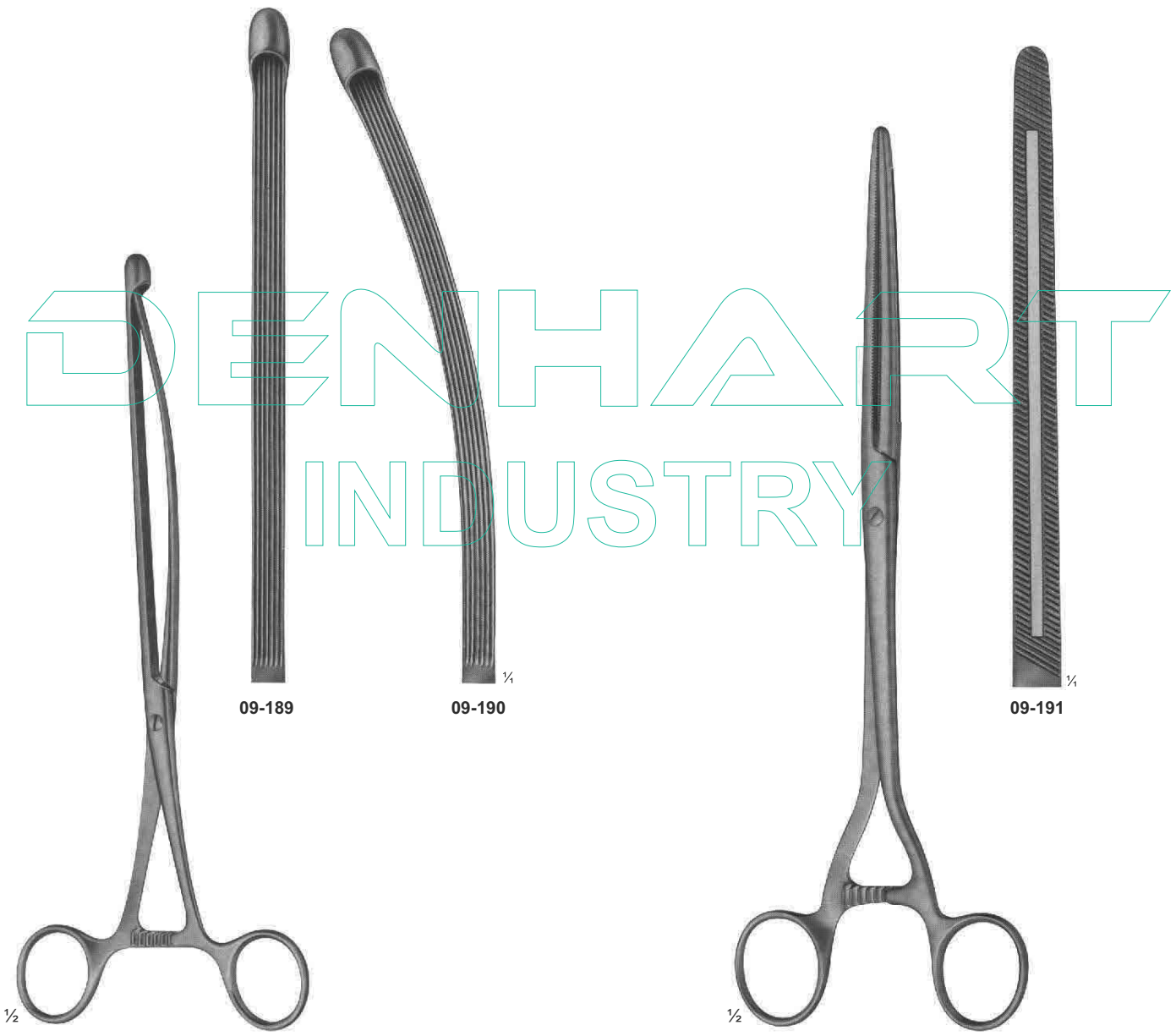

09-189

09-190

09-191

09-189 - 190
NUSSBAUM
with elastic blades
250 mm

09-191
MOYNIHAN
280 mm

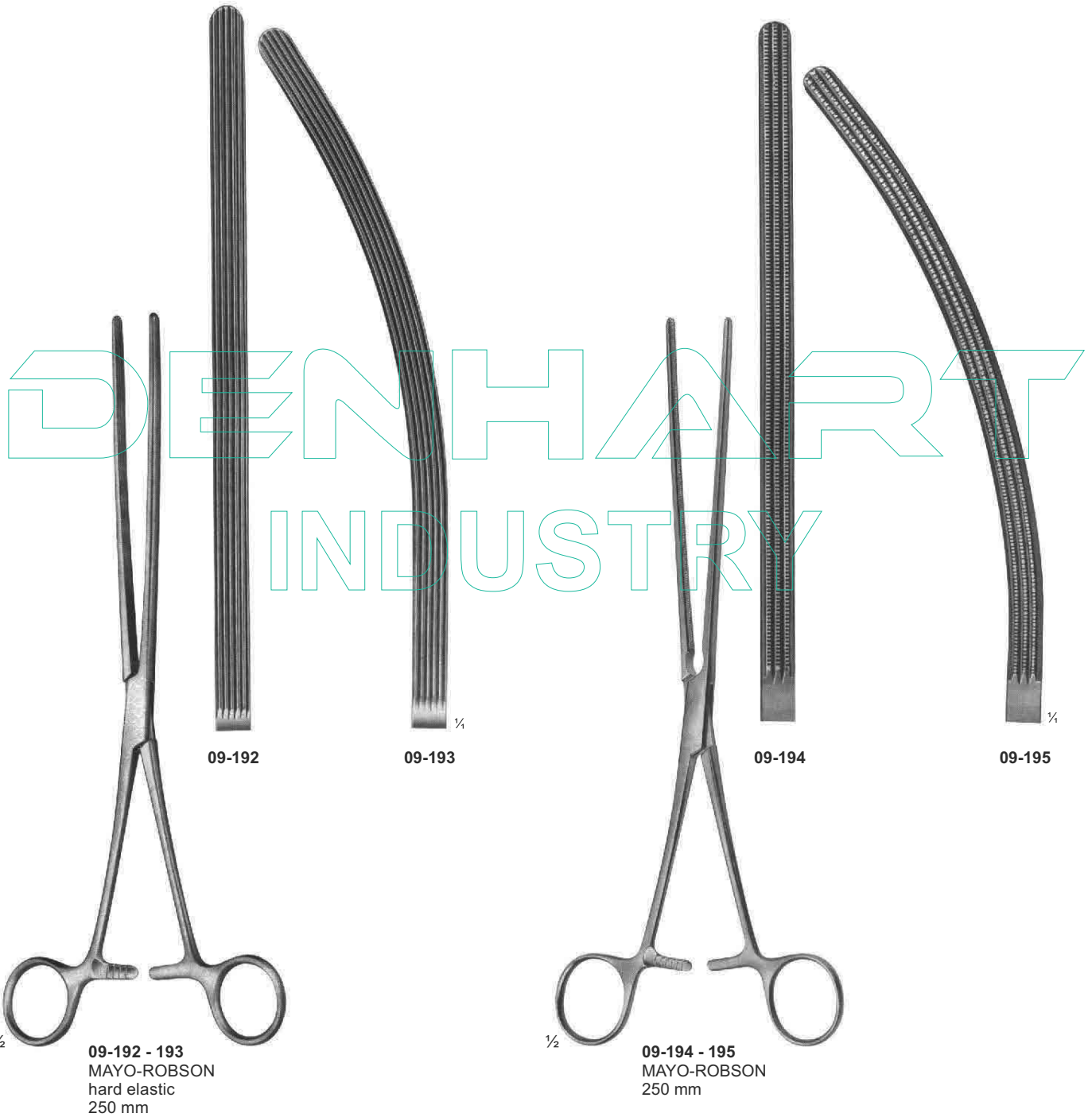



09-196
LANE
300 mm

09-197
LANE
300 mm

DENHART
INDUSTRY

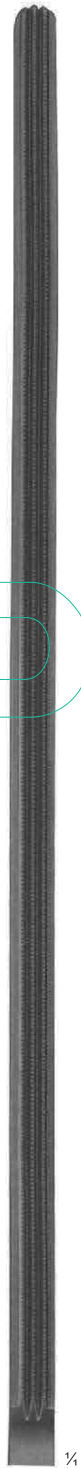

09-198

¼



09-199

¼

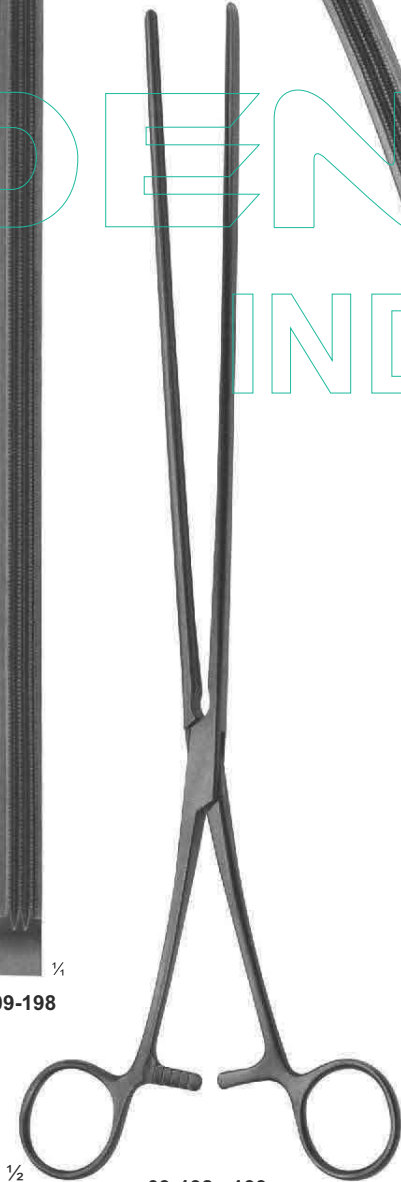

½

09-198 - 199
SCUDDER
330 mm

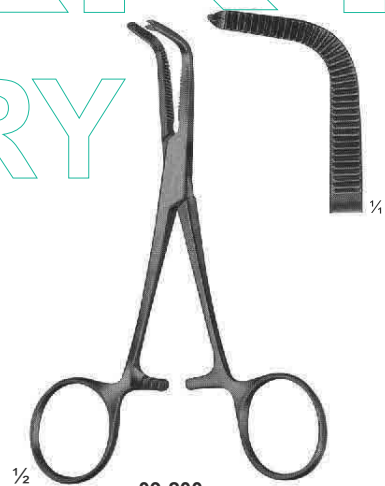

½

09-200
KLEINSCHMIDT
Spur crushers and
Appendectomy clamps
130 mm



¼



09-201
PAYR
Intestinal clamp
light pattern,
for children
180 mm

09-202
PAYR
200 mm

09-203
PAYR
275 mm

09-204
PAYR
Pylorus clamp
315 mm

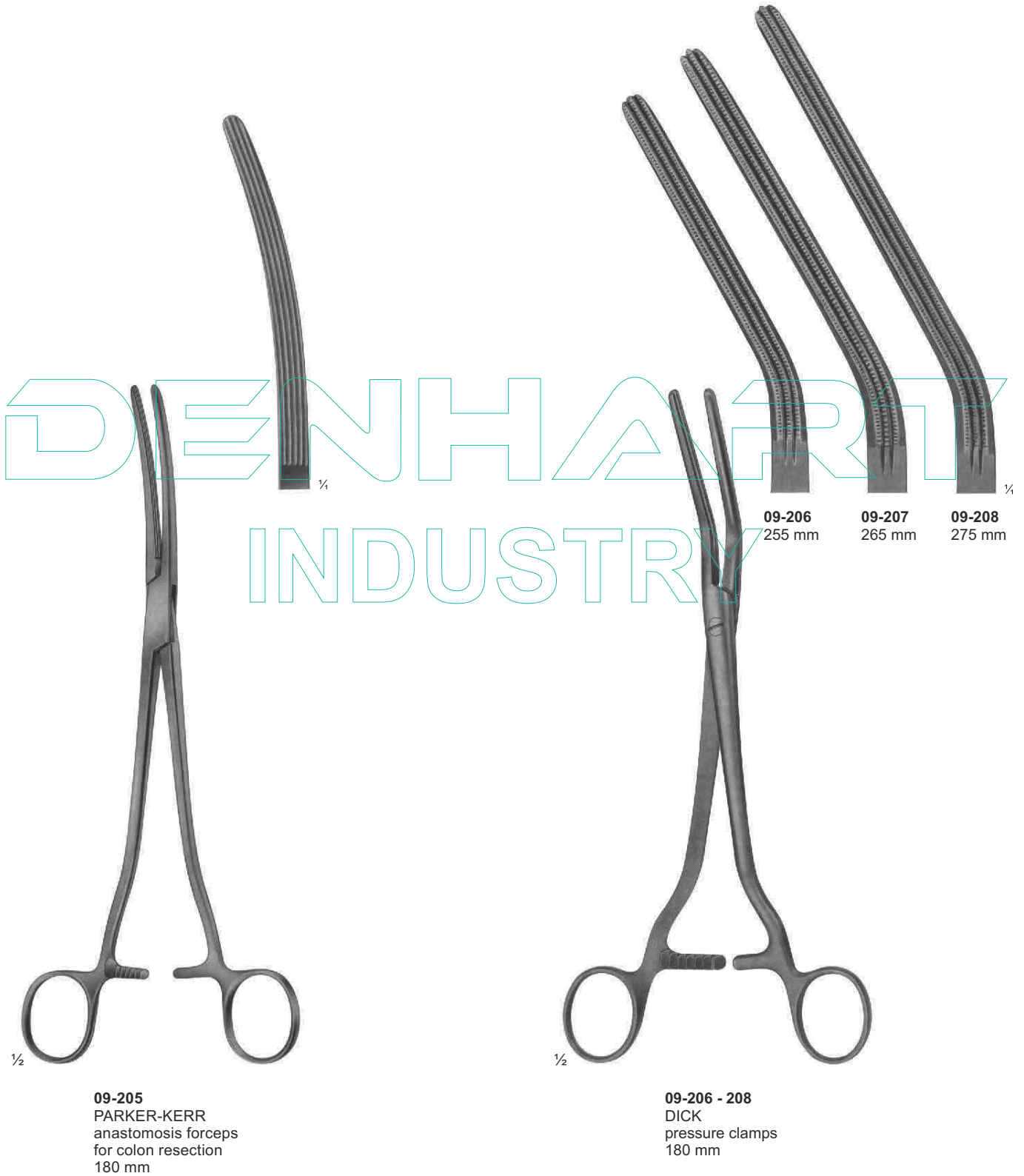

09-205
PARKER-KERR
anastomosis forceps
for colon resection
180 mm

09-206 - 208
DICK
pressure clamps
180 mm

09-206 255 mm
09-207 265 mm
09-208 275 mm

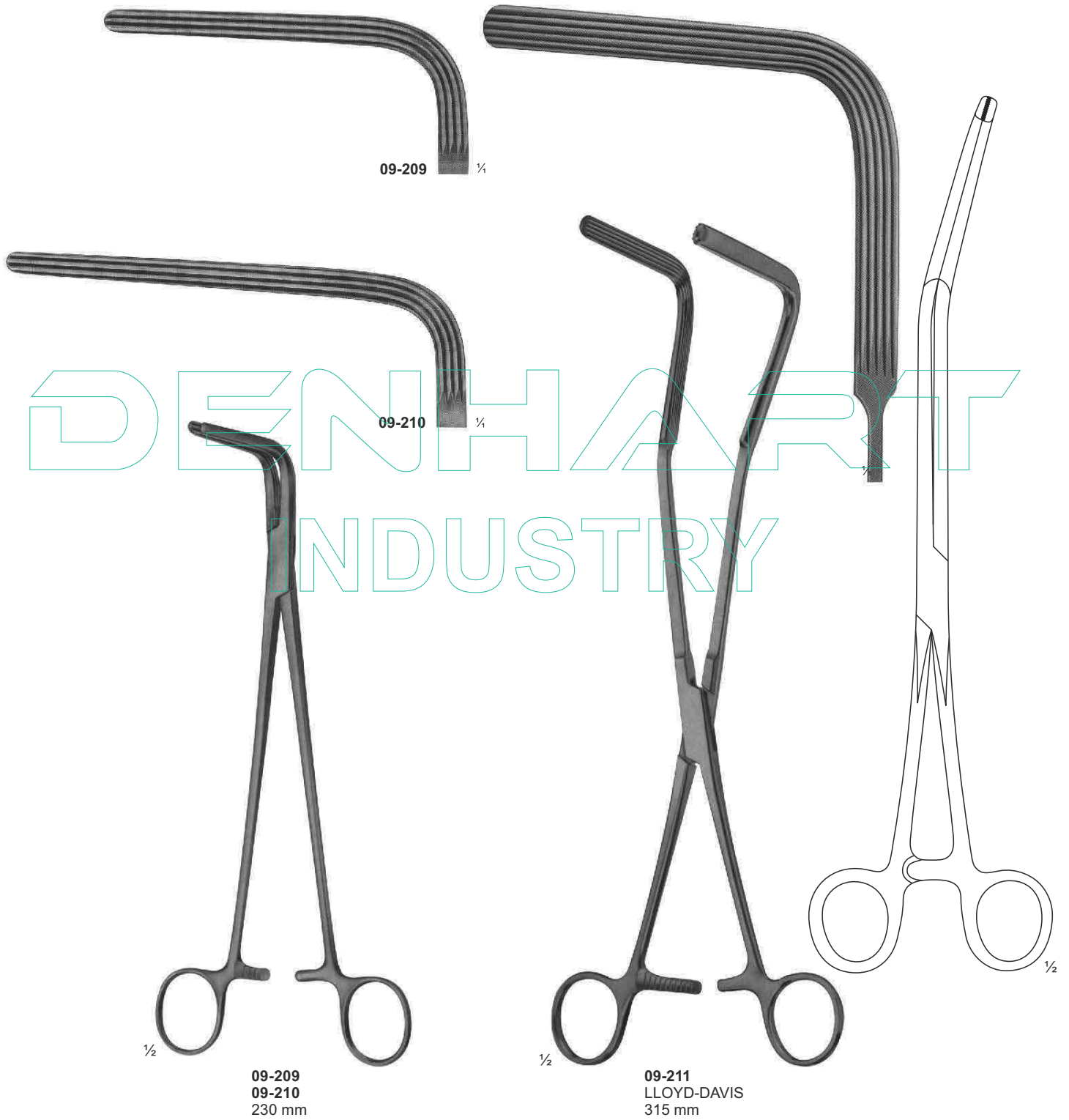

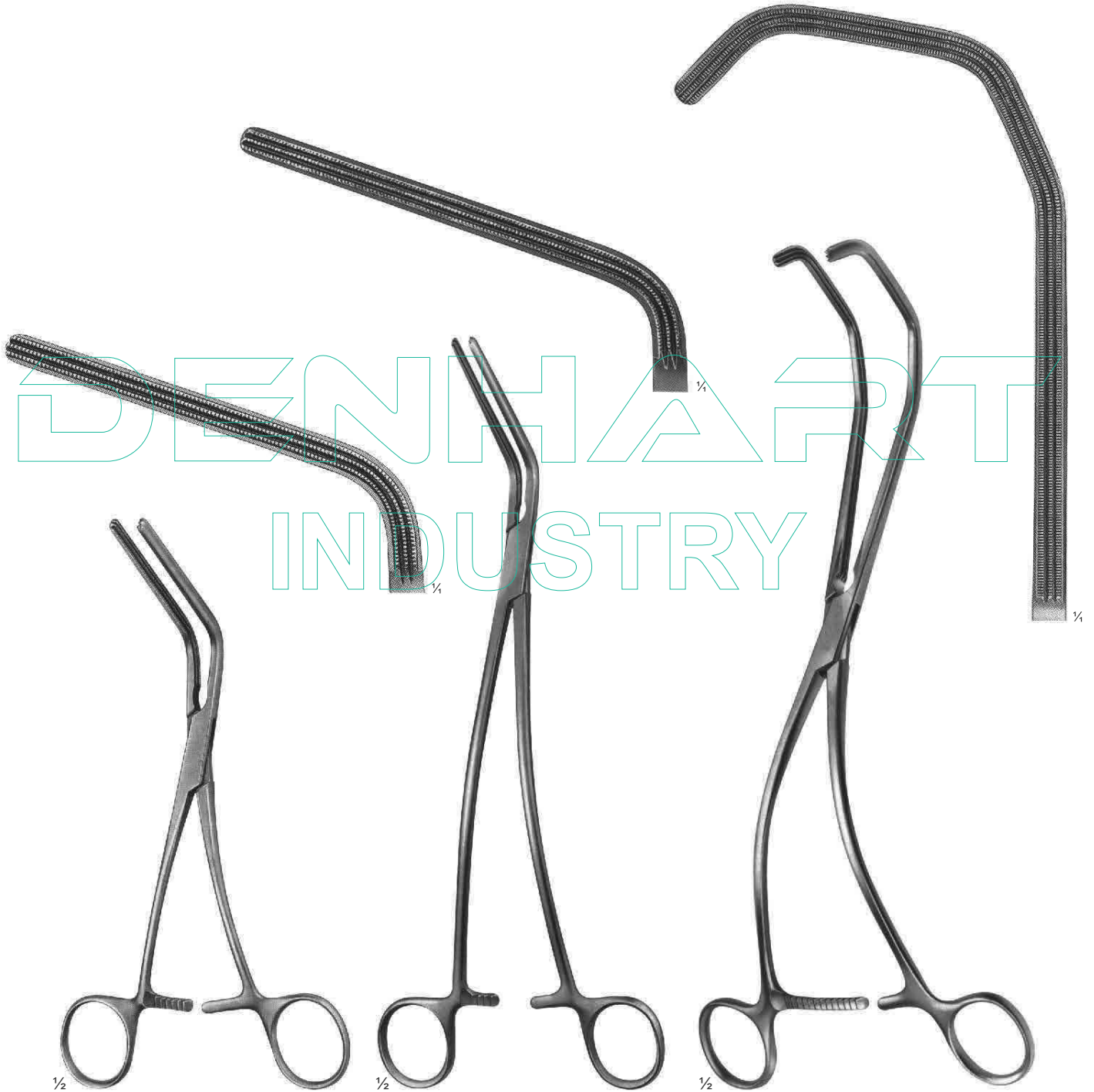

09-212
MORRIS
175 mm

09-213
DE BAKEY
(MORRIS modif.)
240 mm

09-214
KERSTING
270 mm

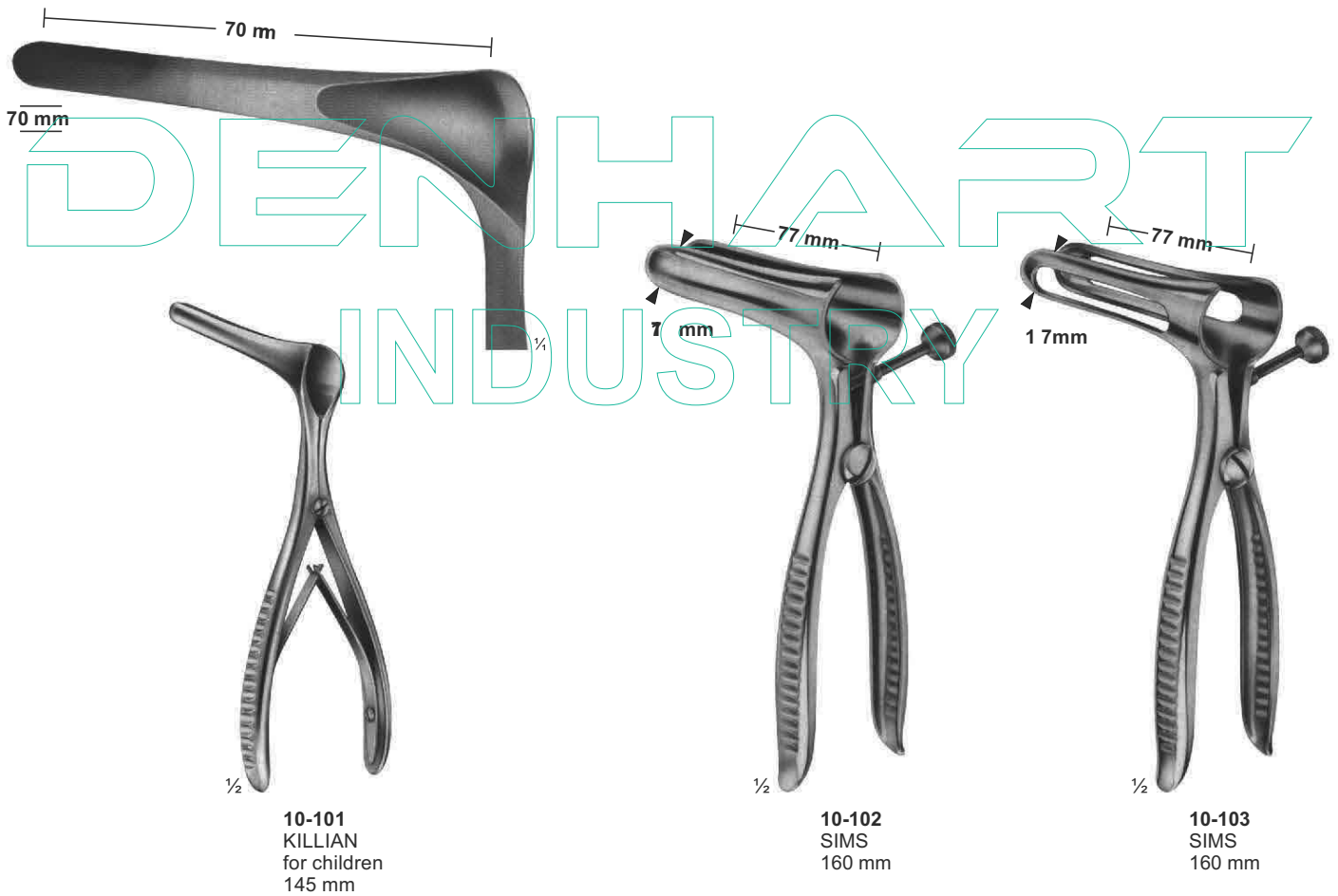

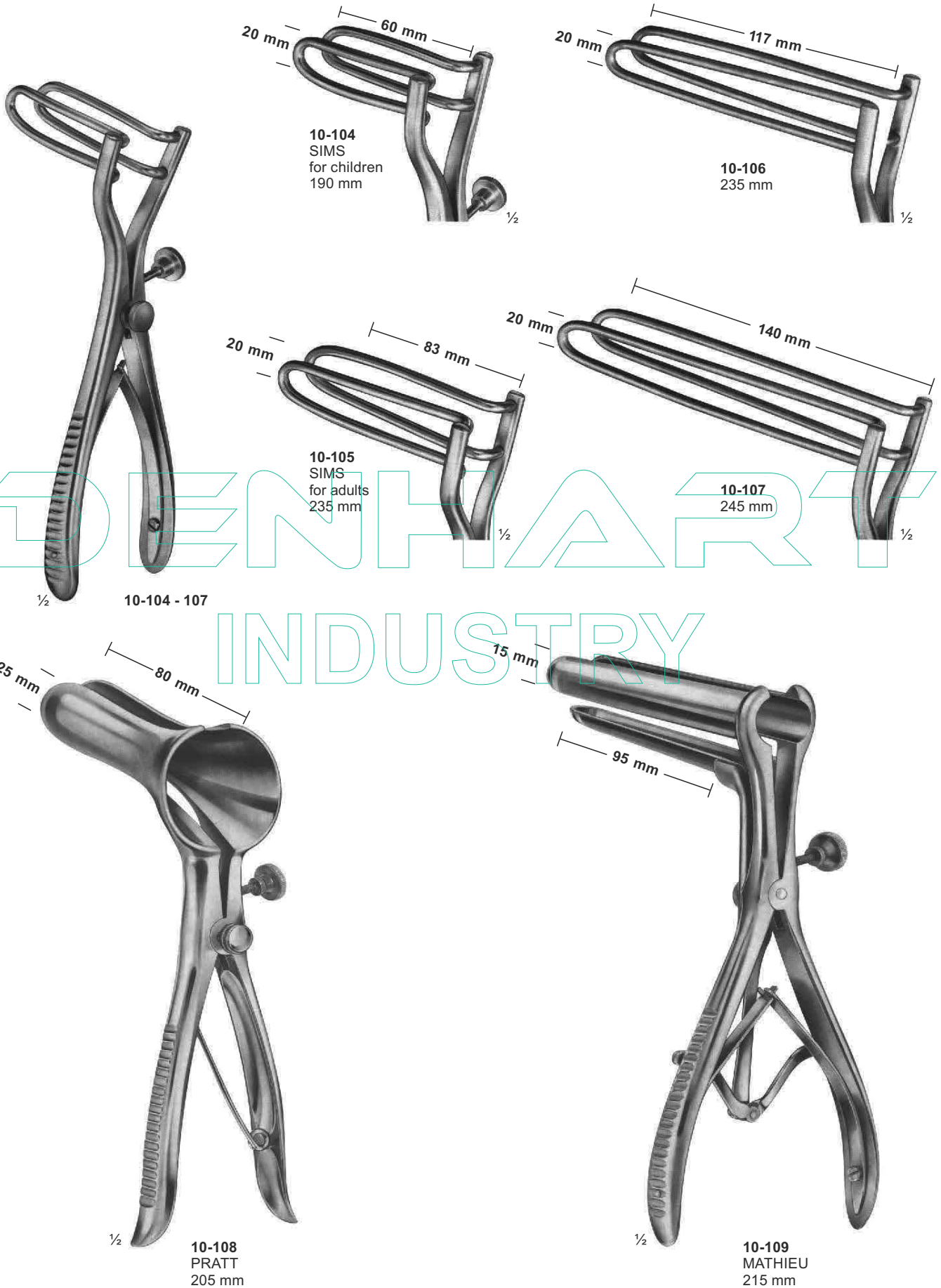



10-110
IVES-FANSLER
Anuscope
145 mm



10-111
KELLY
Sphincteroscope
160 mm



10-112
KELLY
Sphincteroscope
160 mm

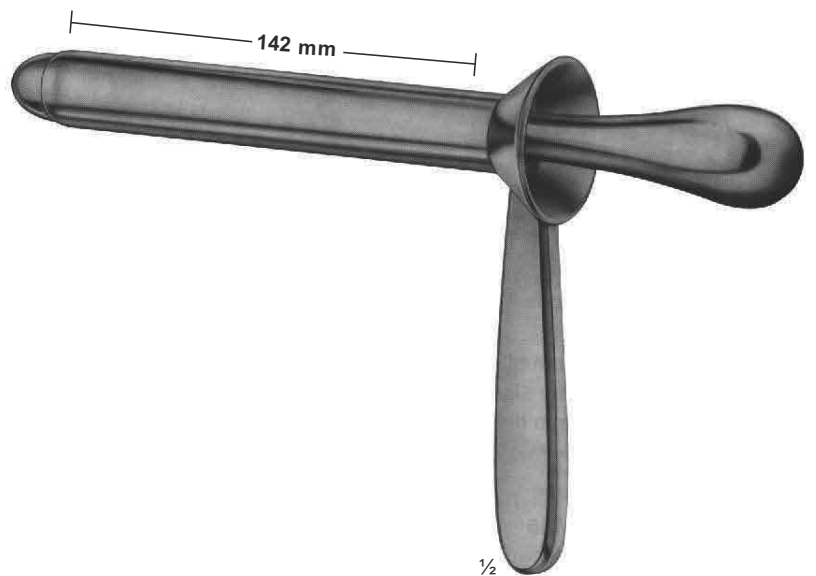

10-113
KELLY
Proctoscope
160 mm

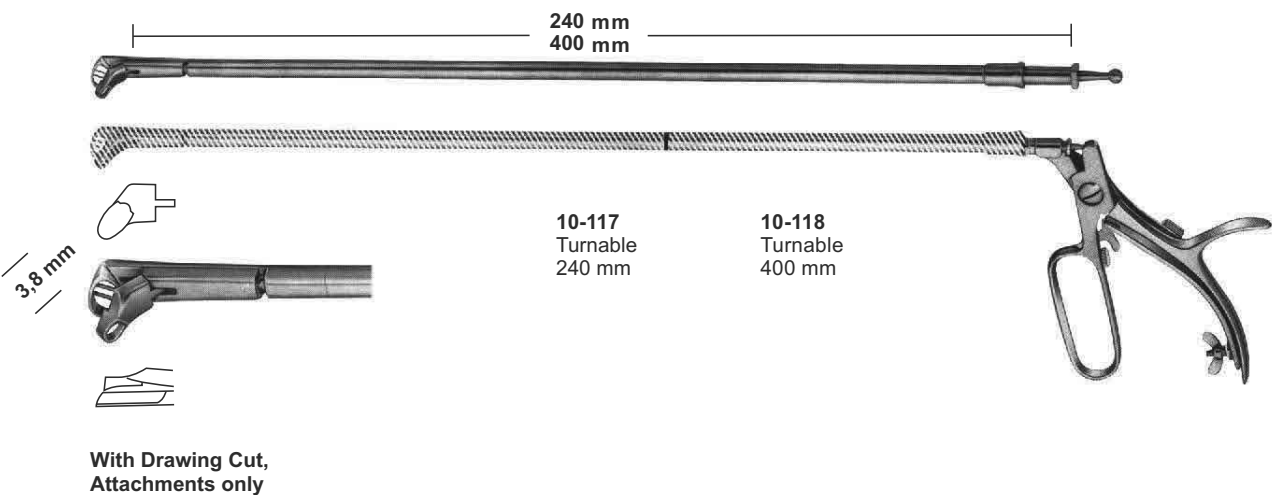
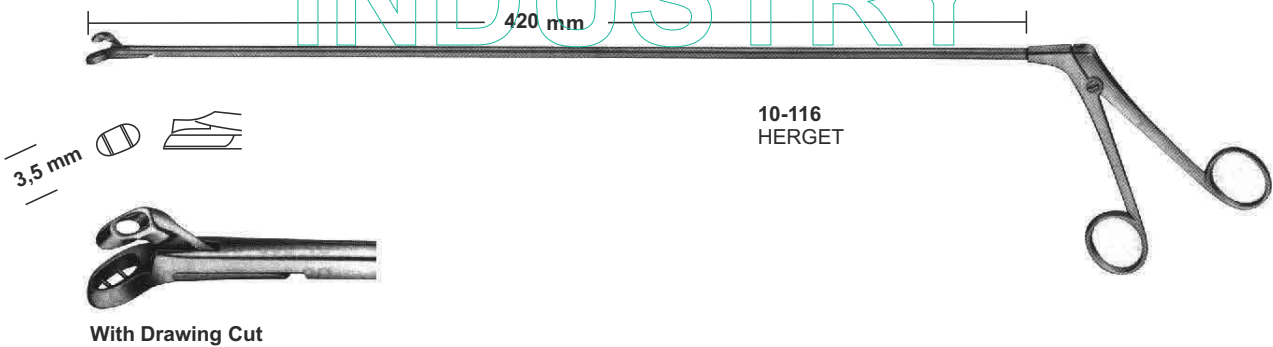
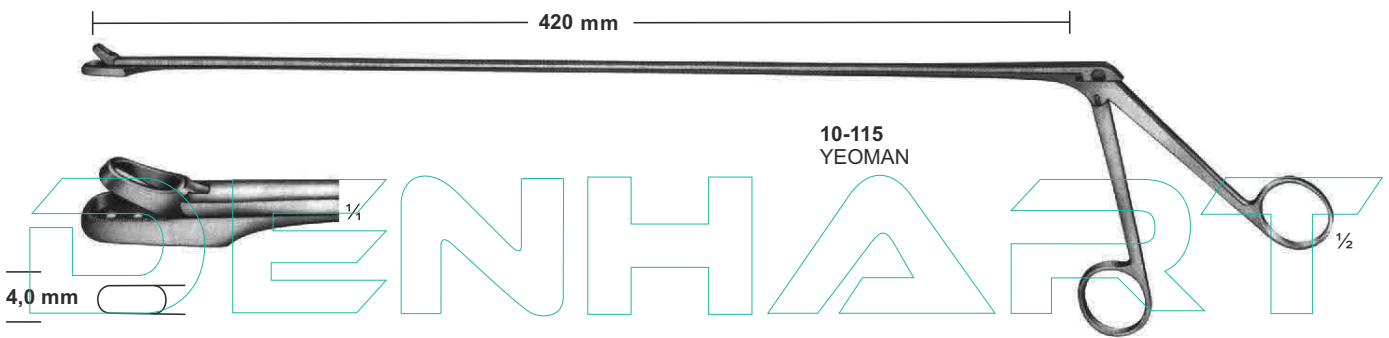
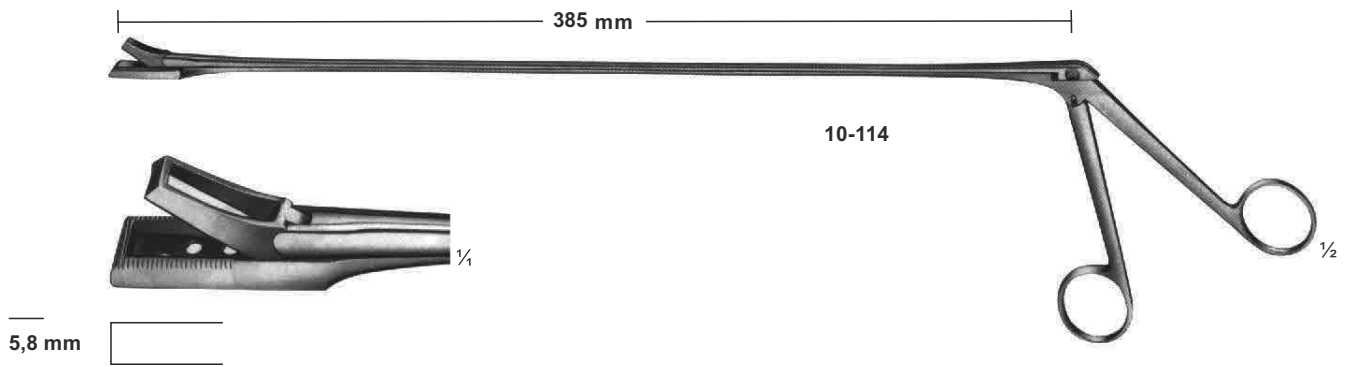

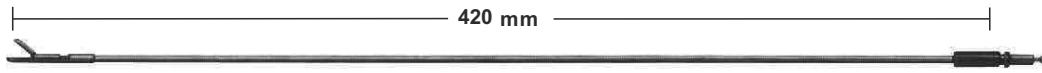

3,5 mm



10-119

3,5 mm



10-120

4,0 mm



10-121

4,0 mm



10-122



10-119 - 122
Handle for 119 - 120 - 121 - 122

DENHART
INDUSTRY

10-123
3,5 mm



10-123 - 124
Biopsy Forceps, spoon-shaped
oval jaws, straight.

10-124
4, mm

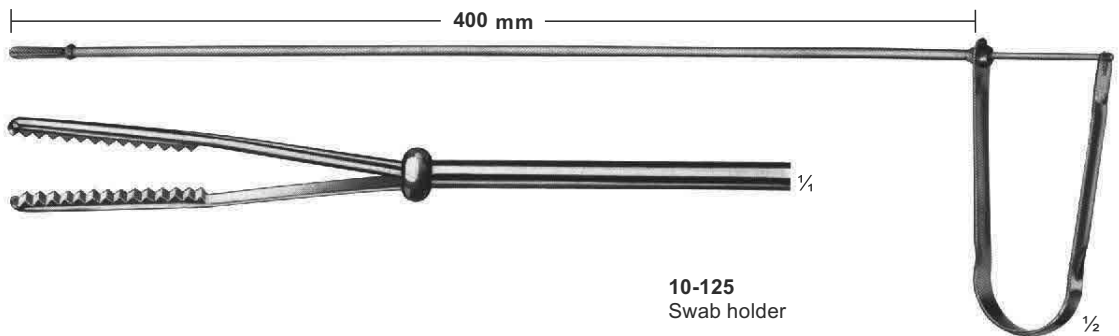

10-125
Swab holder

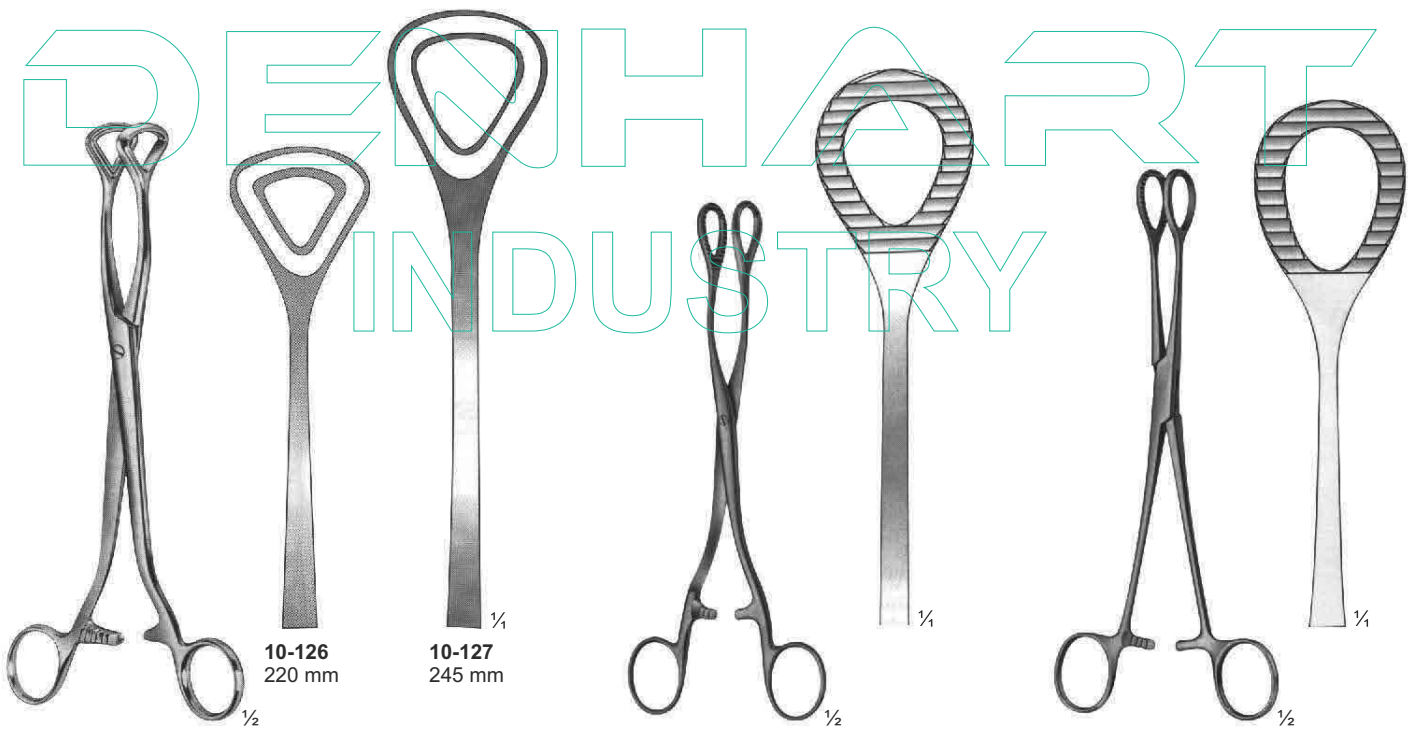

10-126 - 127
LUER

10-126
220 mm

10-127
245 mm

10-128
HEYWOOD-SMITH
200 mm

10-129
HEYWOOD-SMITH
modif
200 mm

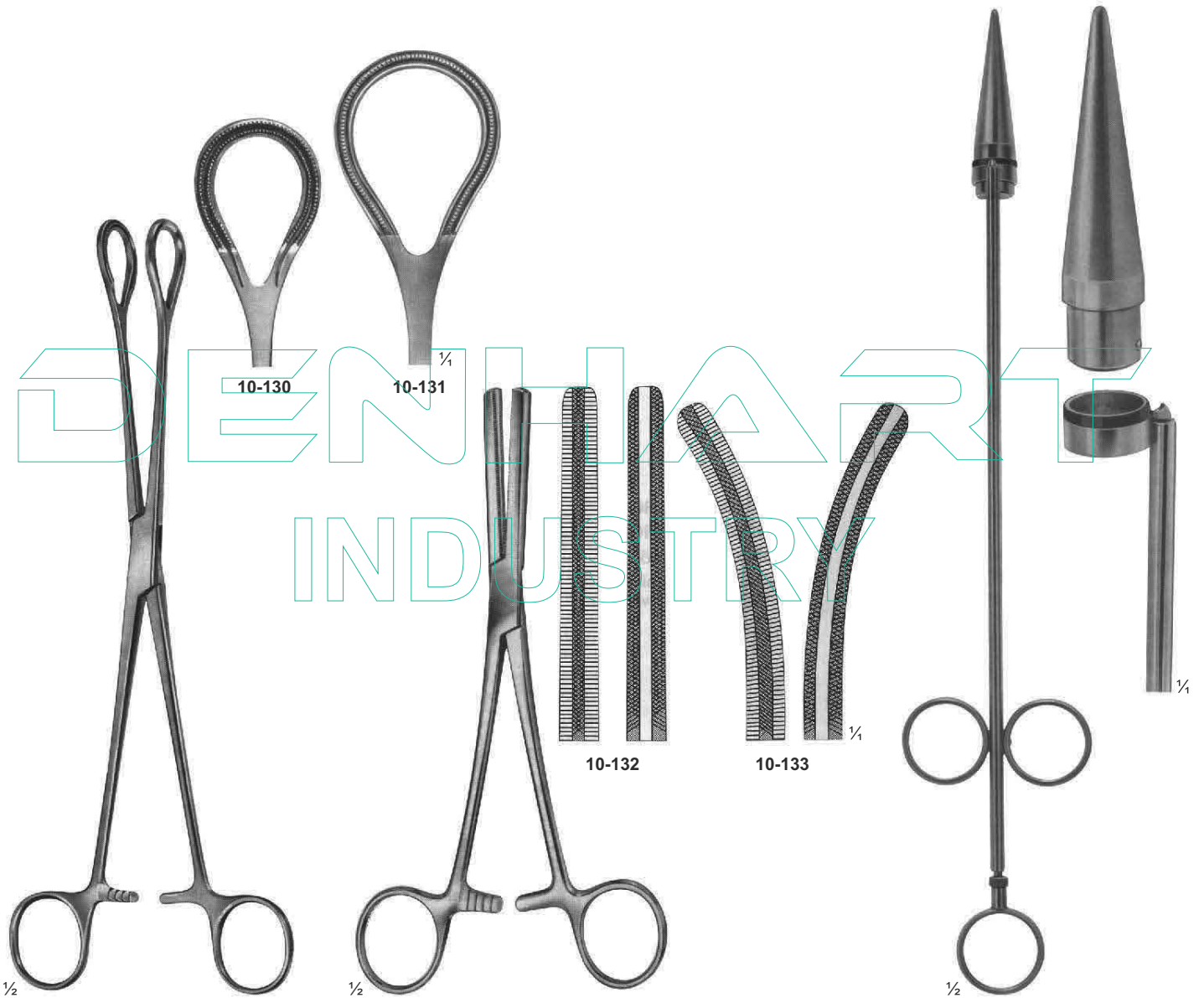

10-130 - 131
250 mm
10-131
270 mm

10-132 - 133
FERGUSSON
200 mm

10-134
RUDD
Haemorrhoidal ligator
with loading
attachment and 100
ligature rubber rings
315 mm

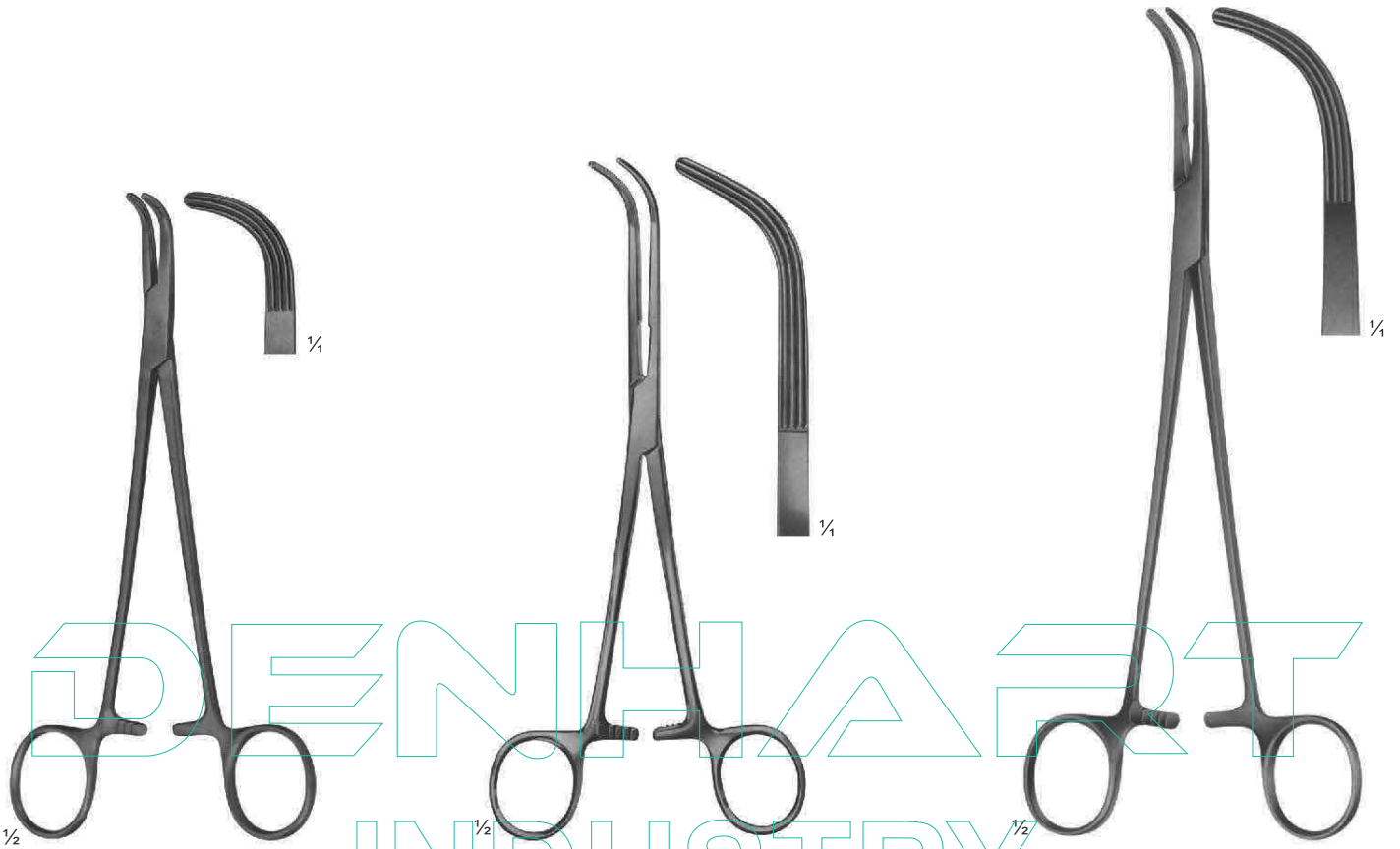

$\frac{1}{2}$
10-135
LOWER
180 mm

$\frac{1}{2}$
10-136
LAHEY (SWEET)
190 mm

$\frac{1}{2}$
10-137
LAHEY
220 mm



$\frac{1}{2}$
10-138
DESJARDINS
Gall duct-and cystic forceps
210 mm

$\frac{1}{2}$
10-139
NISSEN
Gall duct-and cystic forceps
215 mm

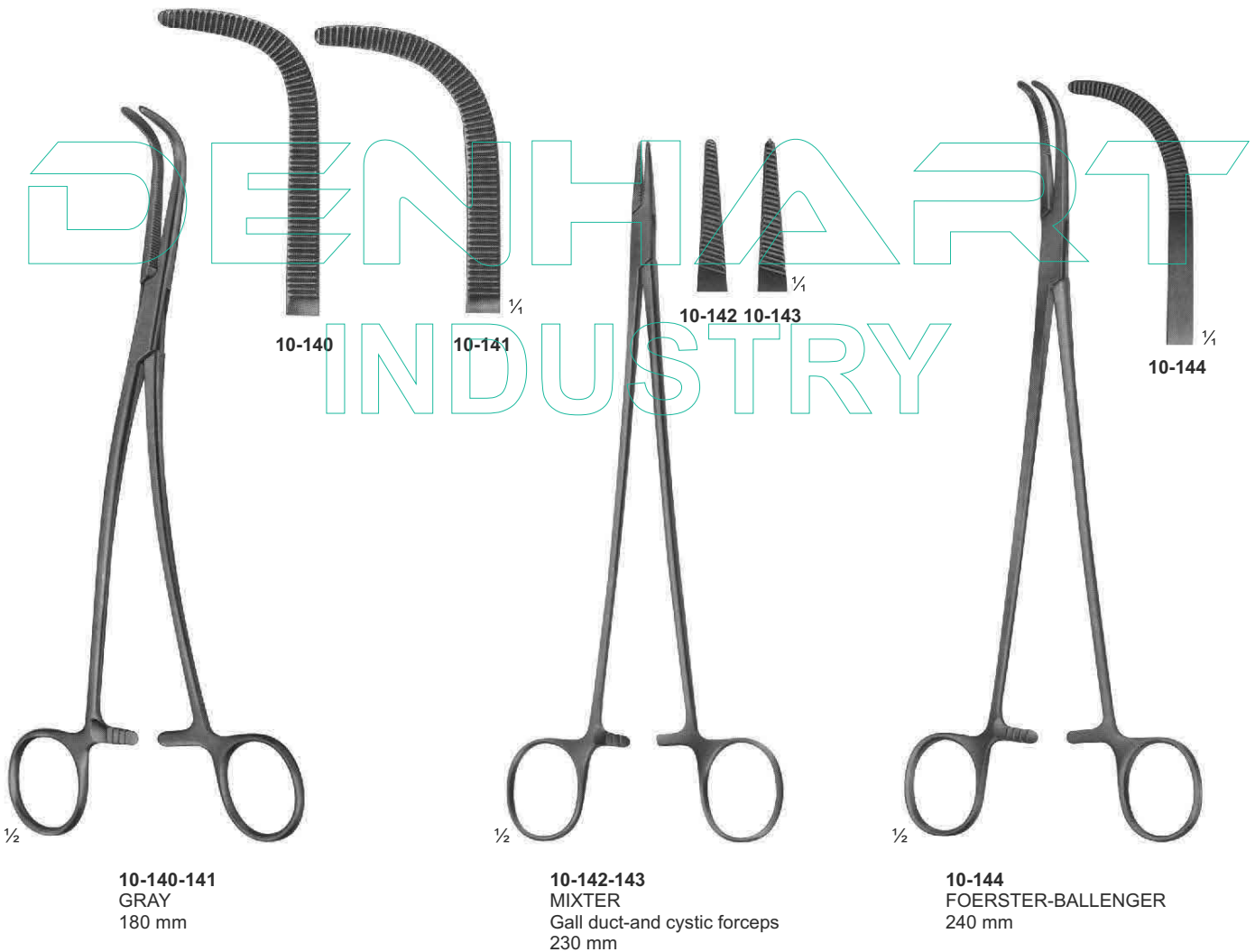

Gall Bladder Forceps and Gall Duct Scissors

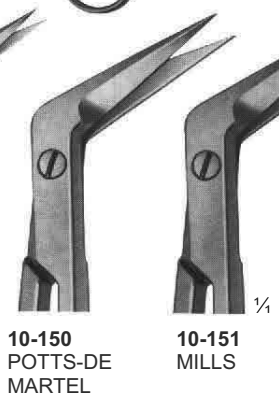
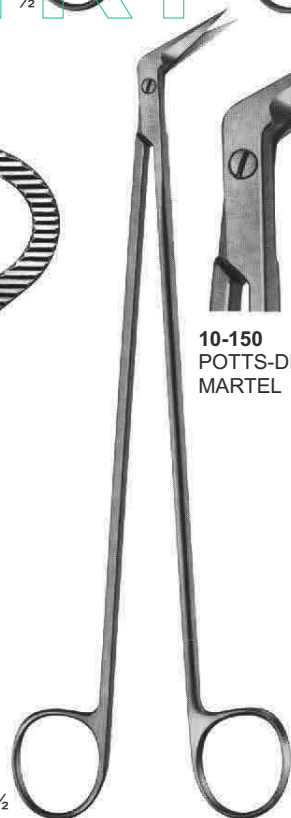
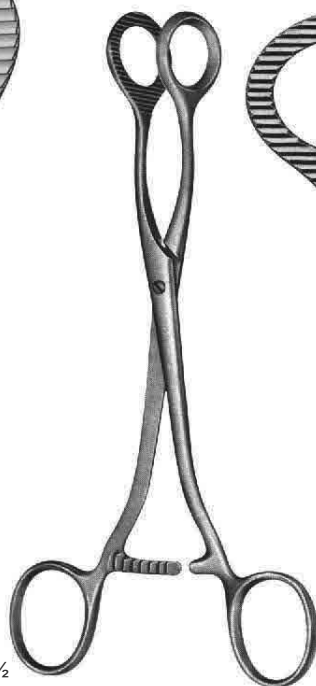
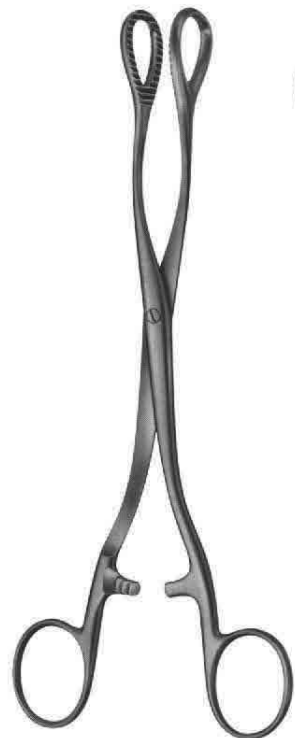
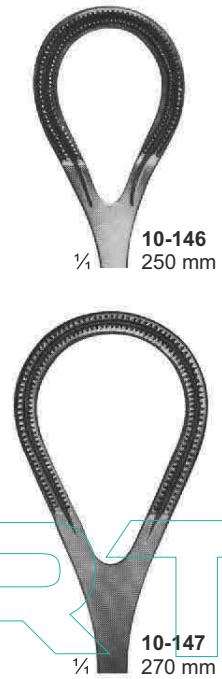
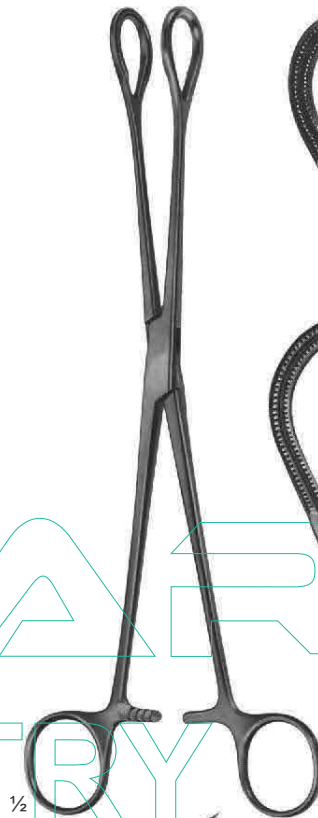
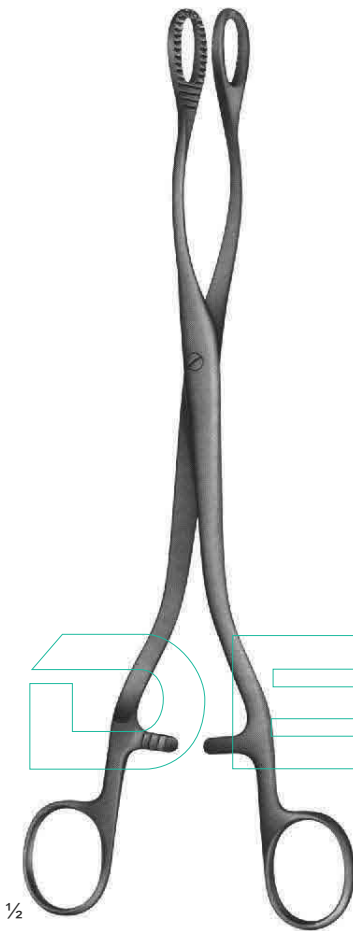

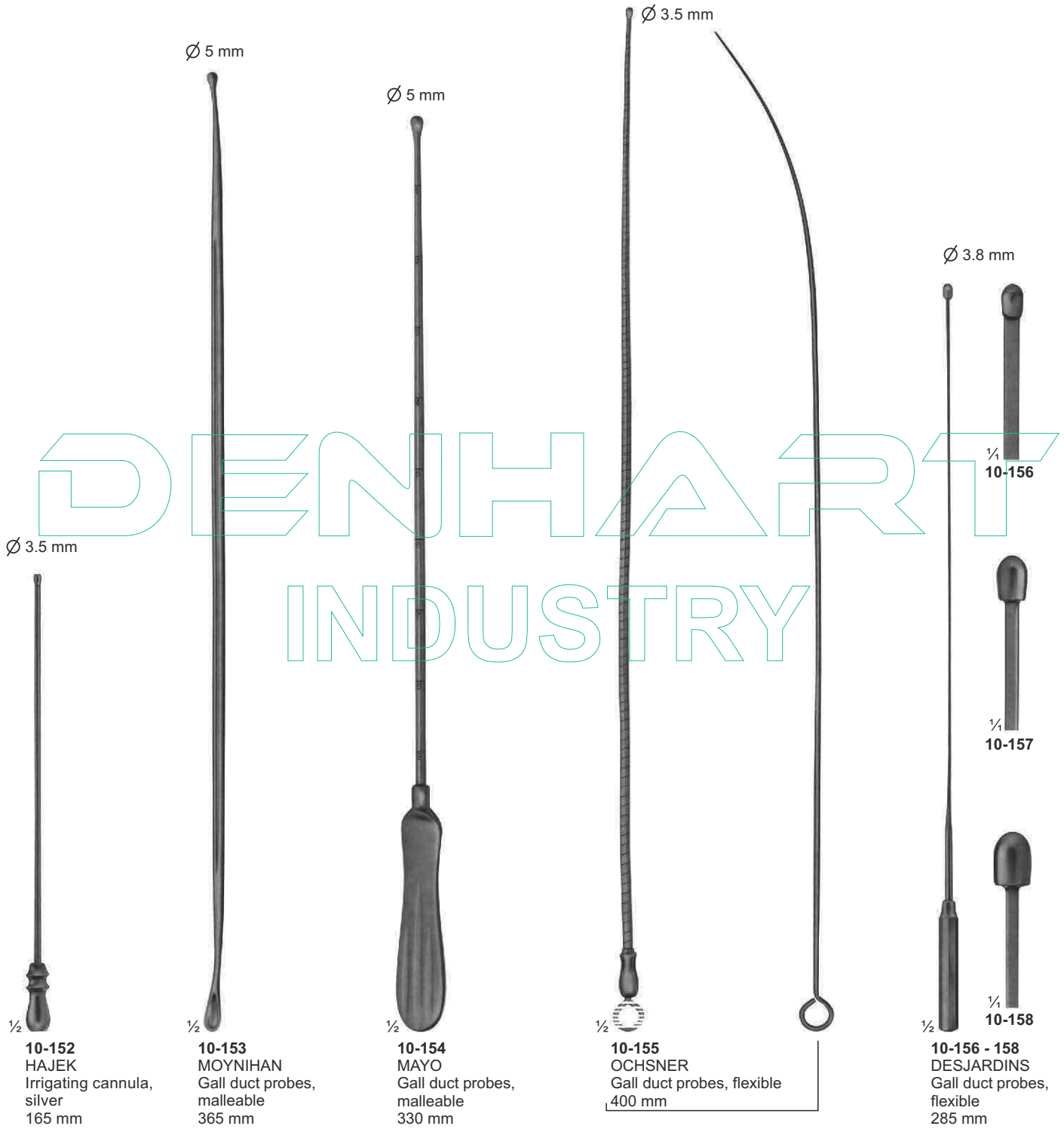

Ø 3.5 mm

Ø 5 mm

Ø 5 mm

Ø 3.5 mm

Ø 3.8 mm

1/2
10-152
HAJEK
Irrigating cannula,
silver
165 mm

1/2
10-153
MOYNIHAN
Gall duct probes,
malleable
365 mm

1/2
10-154
MAYO
Gall duct probes,
malleable
330 mm

1/2
10-155
OCHSNER
Gall duct probes, flexible
400 mm

1/4
10-156 - 158
DESJARDINS
Gall duct probes,
flexible
285 mm

1/4
10-156

1/4
10-157

1/4
10-158

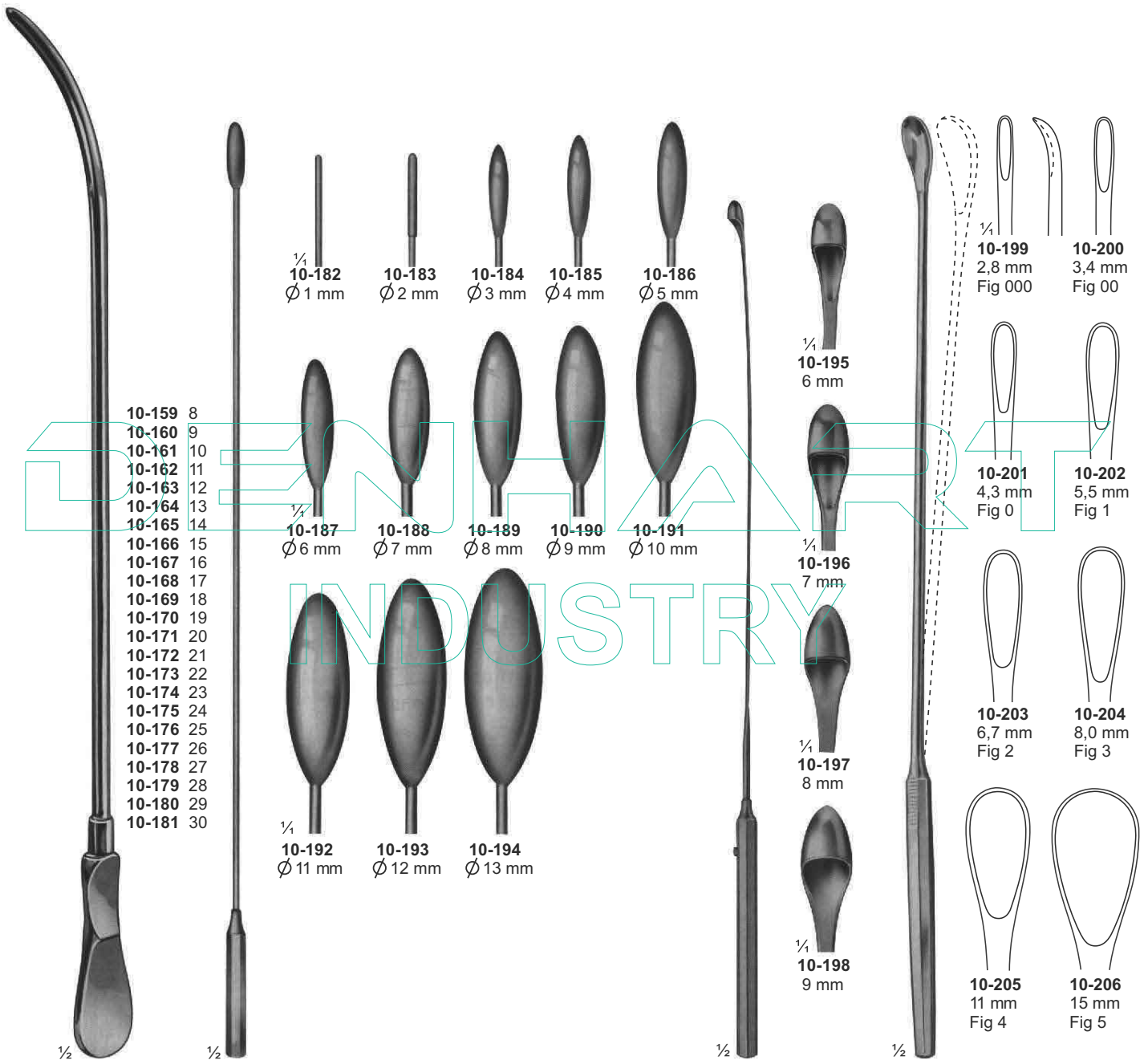

10-159 - 181
DITTEL
Metall bougies and
dilating sounds, stiff
345 mm

10-182 - 194
BAKES
Common bile duct
dilators, malleable
315 mm, 320 mm

10-195 - 198
DESJARDINS
Probes and catch
with flexible shaft
300 mm

10-199 - 206
LUER-KORTE modif
with malleable shaft
310 mm

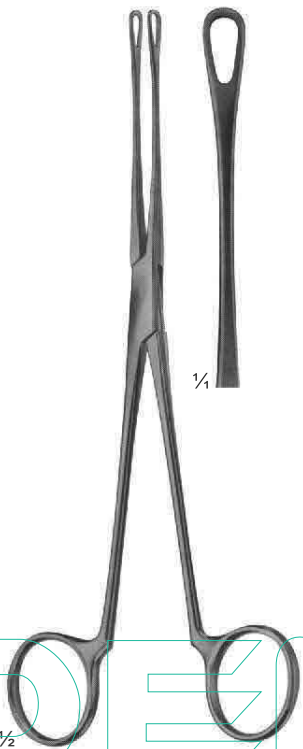

10-207
BLAKE
205 mm

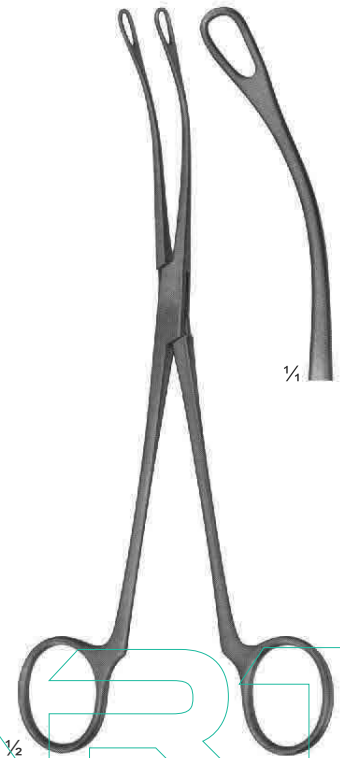

10-208
BLAKE
205 mm

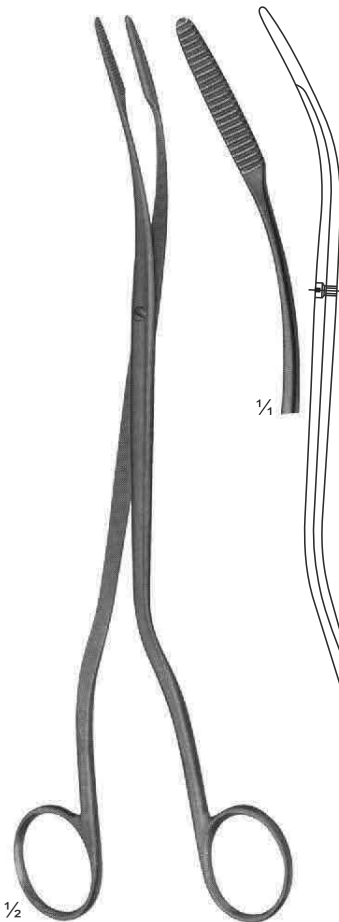

10-209
CZERNY
245 mm

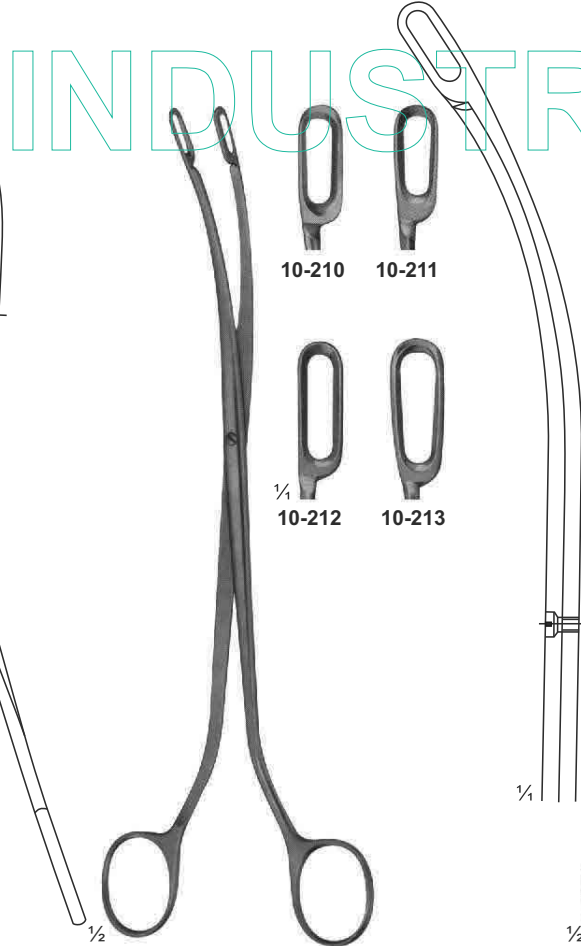

10-210 - 213
DESJARDINS
225 mm

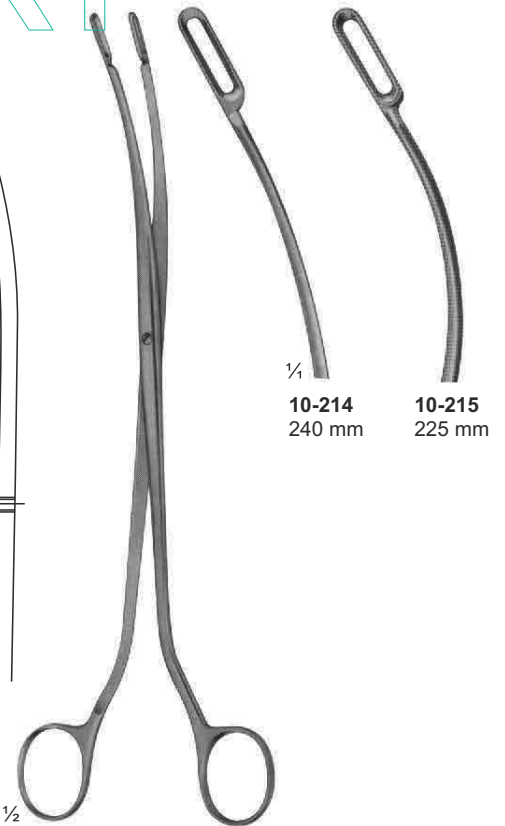

10-214 - 215
DESJARDINS
Extremely delicate patterns

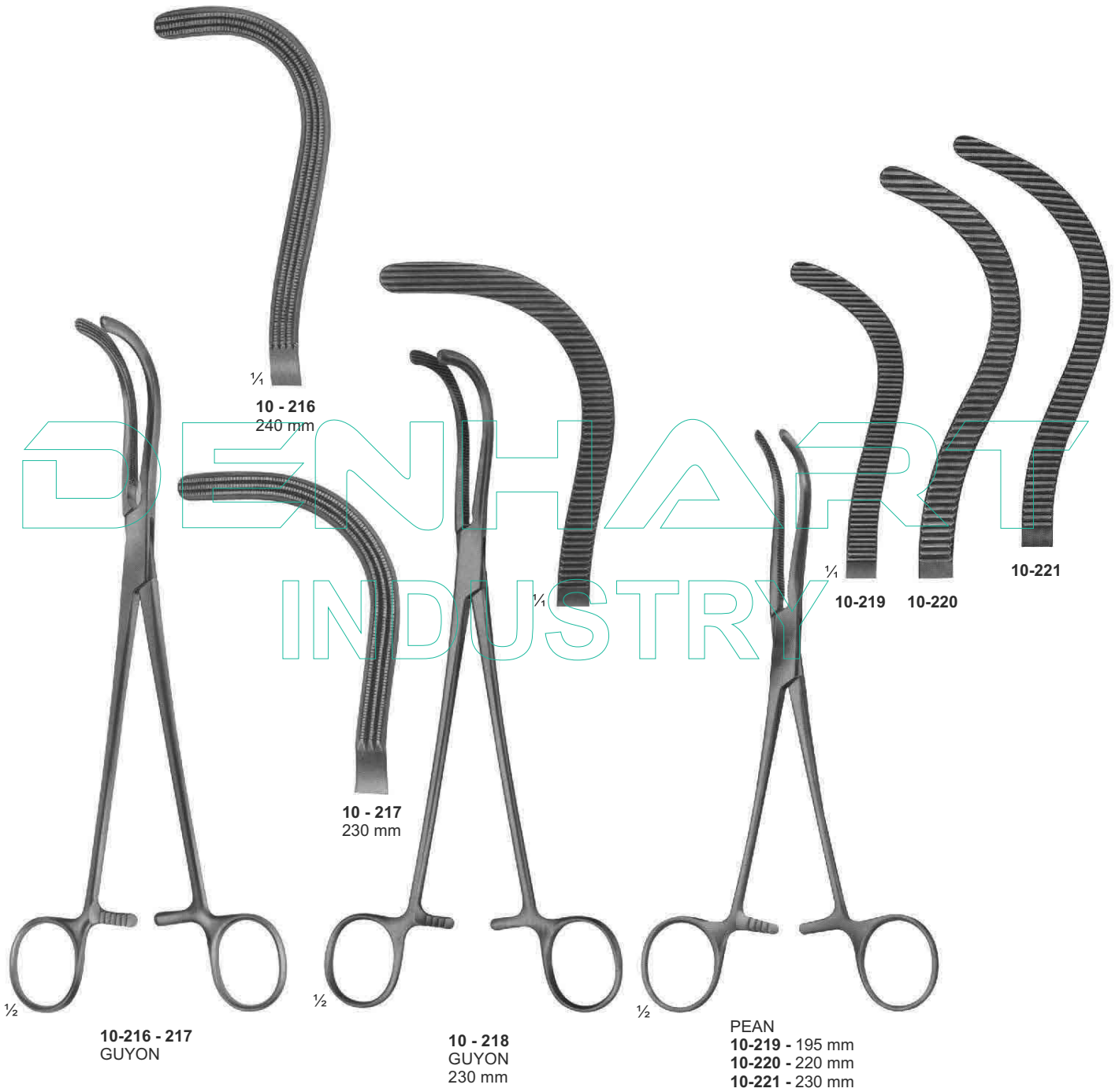

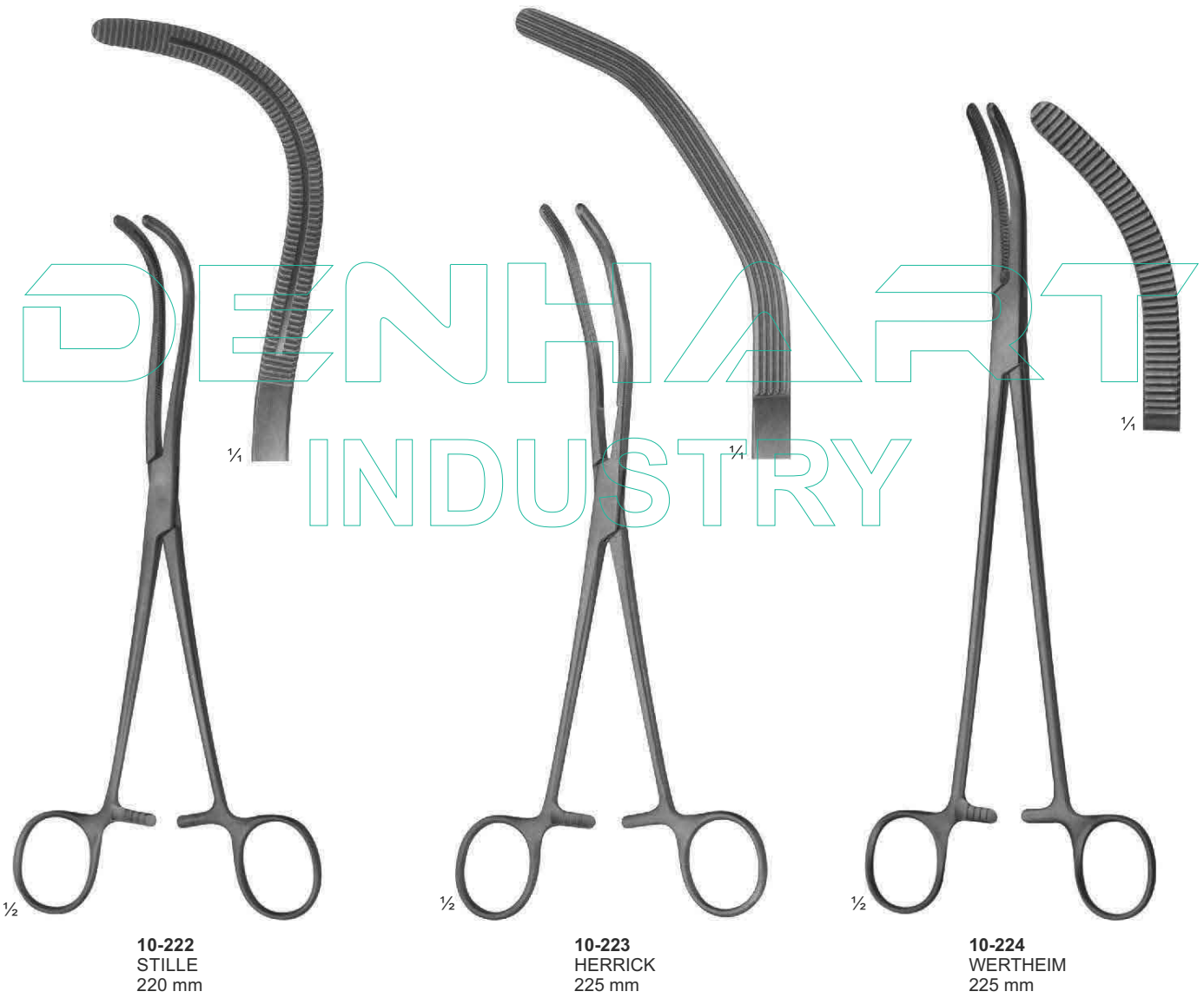



1/2

10-225
COLLIN
285 mm

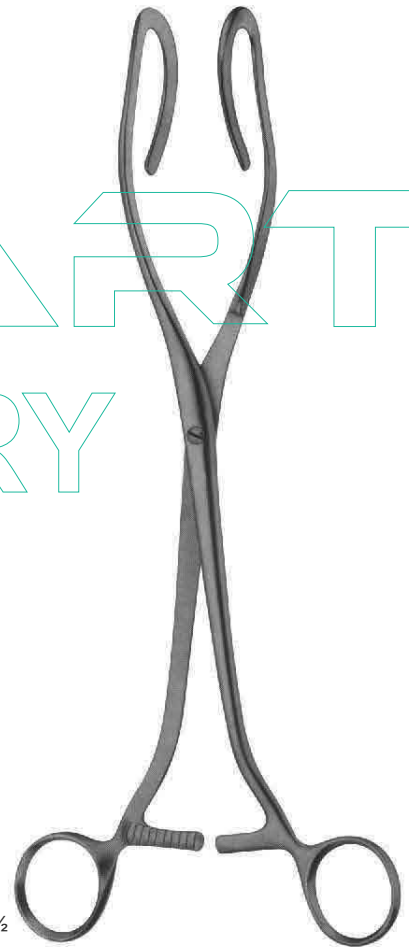

1/2

10-226
DARTIGUES
255 mm

DENHART
INDUSTRY



10-227



10-231



10-228



10-232



1/2

10-227 - 230
RANDALL
225 mm



10-229



1/4
10-230



1/2

10-231 - 233
RANDALL
190 mm

DENHART
INDUSTRY

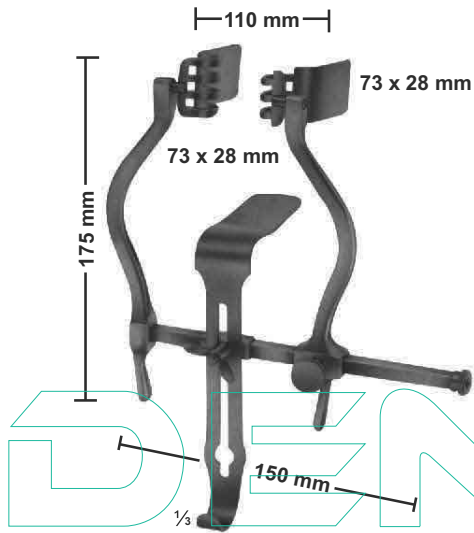

11-101
JUDD-MASSON
Bladder-and suprapubic
retractor



11-102
MILLIN
Bladder retractor
105X45 mm



11-103
LEGUEU
Bladder retractor
Center blade
80 x 31 mm

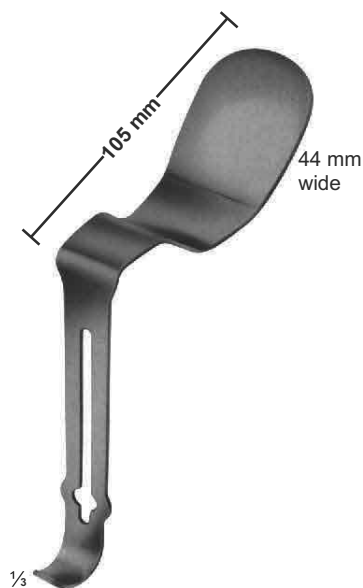

11-104
MILLIN
Center bladder for
retro pubic prostatectomy

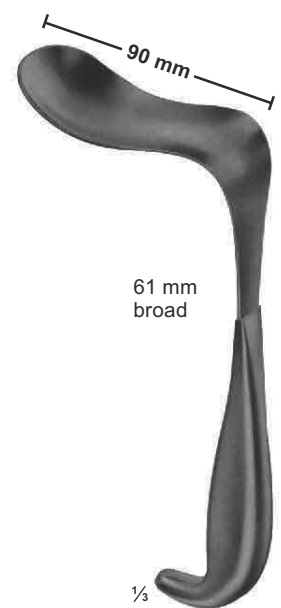

11-105
KOCHER
Bladder spatula
235 mm



11-106
MATHIEU
Foreign body forceps
Length of shaft
190 mm

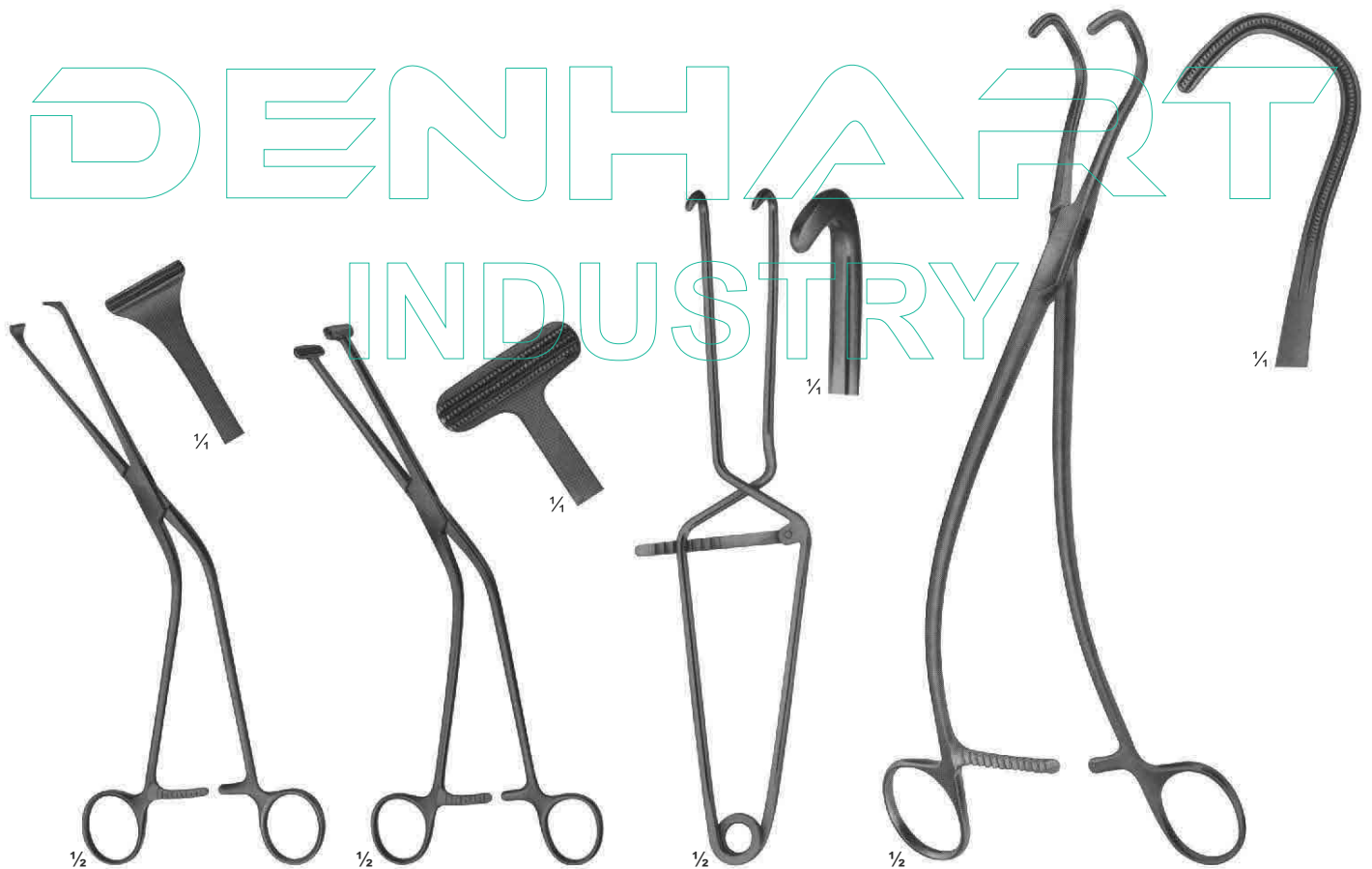

11-107
MILLIN
Lobe grasping
forceps
245 mm

11-108
MILLIN
Lobe grasping
forceps
235 mm

11-109
MILLIN
Bladder neck
spreader
285 mm

11-110
Ureter
forceps
240 mm



11-111
GUYON
Catheter guide
(introducer)
365 mm

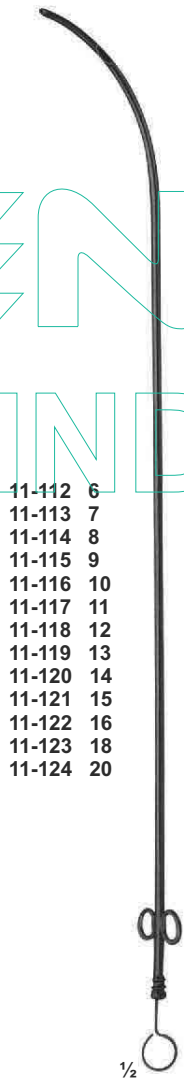

11-112 - 124
Female catheters,
metal
160 mm

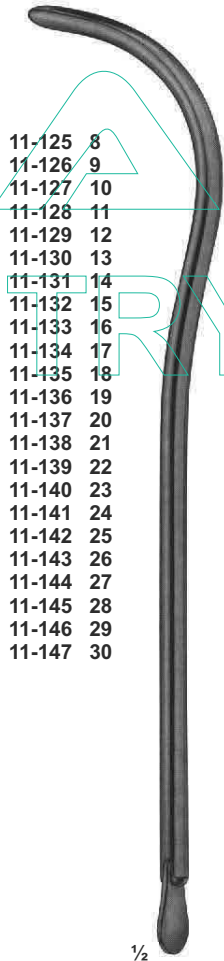

11-125 - 147
Urethral bougies
and dilating sounds
345 mm

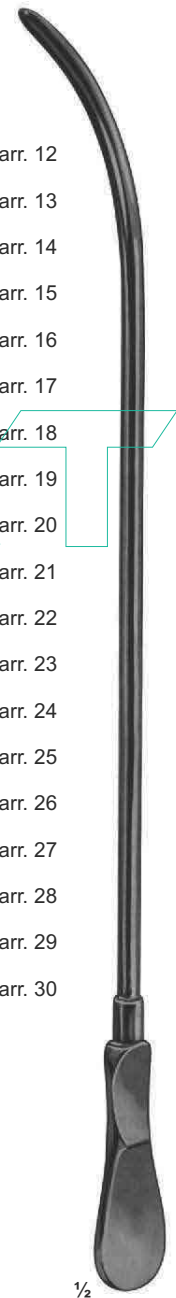

11-148 - 184
Urethral bougies
and dilating sounds
255 mm

- 11-148 Ben. 24/Charr. 12
- 11-149 Ben. 25
- 11-150 Ben. 26/Charr. 13
- 11-151 Ben. 27
- 11-152 Ben. 28/Charr. 14
- 11-153 Ben. 29
- 11-154 Ben. 30/Charr. 15
- 11-155 Ben. 31
- 11-156 Ben. 32/Charr. 16
- 11-157 Ben. 33
- 11-158 Ben. 34/Charr. 17
- 11-159 Ben. 35
- 11-160 Ben. 36/Charr. 18
- 11-161 Ben. 37
- 11-162 Ben. 38/Charr. 19
- 11-163 Ben. 39
- 11-164 Ben. 40/Charr. 20
- 11-165 Ben. 41
- 11-166 Ben. 42/Charr. 21
- 11-167 Ben. 43
- 11-168 Ben. 44/Charr. 22
- 11-169 Ben. 45
- 11-170 Ben. 46/Charr. 23
- 11-171 Ben. 47
- 11-172 Ben. 48/Charr. 24
- 11-173 Ben. 49
- 11-174 Ben. 50/Charr. 25
- 11-175 Ben. 51
- 11-176 Ben. 52/Charr. 26
- 11-177 Ben. 53
- 11-178 Ben. 54/Charr. 27
- 11-179 Ben. 55
- 11-180 Ben. 56/Charr. 28
- 11-181 Ben. 57
- 11-182 Ben. 58/Charr. 29
- 11-183 Ben. 59
- 11-184 Ben. 60/Charr. 30

- 11-125 8
- 11-126 9
- 11-127 10
- 11-128 11
- 11-129 12
- 11-130 13
- 11-131 14
- 11-132 15
- 11-133 16
- 11-134 17
- 11-135 18
- 11-136 19
- 11-137 20
- 11-138 21
- 11-139 22
- 11-140 23
- 11-141 24
- 11-142 25
- 11-143 26
- 11-144 27
- 11-145 28
- 11-146 29
- 11-147 30

- 11-112 6
- 11-113 7
- 11-114 8
- 11-115 9
- 11-116 10
- 11-117 11
- 11-118 12
- 11-119 13
- 11-120 14
- 11-121 15
- 11-122 16
- 11-123 18
- 11-124 20

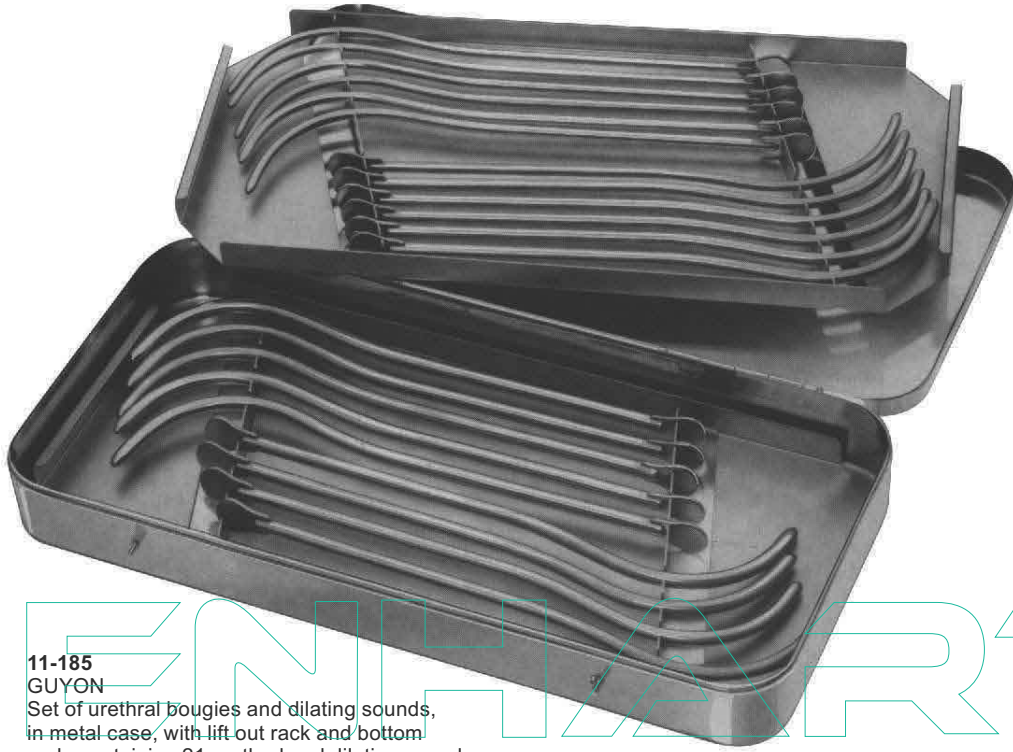

11-185
GUYON
Set of urethral bougies and dilating sounds,
in metal case, with lift out rack and bottom
rack, containing 21 urethral and dilating sounds.

INDUSTRY



11-186
WINKELMANN
Circumcision Clamps
12 mm / 16 mm / 20 mm



11-187
KLIMAROSEGGER
35 X 1,8 mm
Sternal puncture needle

11-188
Universal trocar
with 4 tips

11-189 - 193
Inside dime. Outside dime
11-189 2,2 mm 3,0 mm
11-190 3,0 mm 4,0 mm
11-191 4,0 mm 5,0 mm
11-192 5,0 mm 6,0 mm
11-193 5,5 mm 6,5 mm
 for hydrocele and abdominal puncture

11-194 - 197
Inside dime. Outside dime
11-194 2,2 mm 3,0 mm
11-195 3,0 mm 4,0 mm
11-196 4,0 mm 5,0 mm
11-197 5,0 mm 6,0 mm
 for abdominal puncture,
 with stop-cock and lateral drain

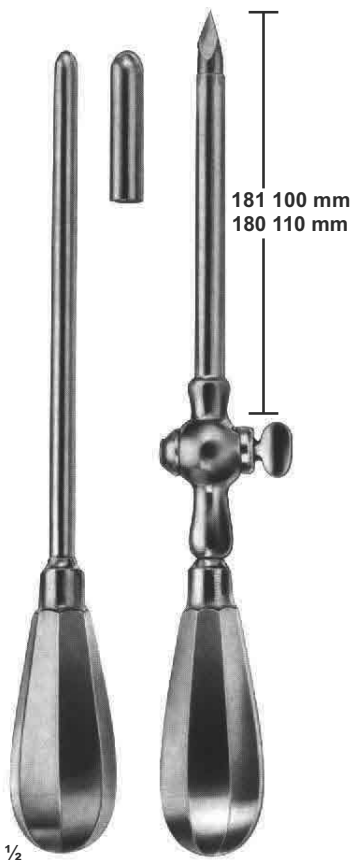

11-198 - 199
Inside dime. Outside dime
11-198 6,5 mm 8,0 mm
11-199 9,0 mm 10,0 mm
 Empyema trocar

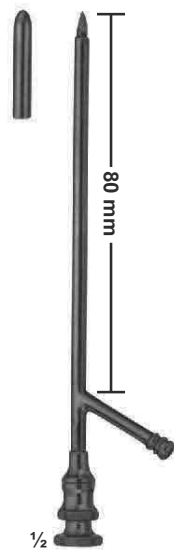

11-200 - 203
Inside dime. Outside dime
11-200 3,0 mm 4,0 mm
11-201 3,6 mm 4,6 mm
11-202 4,3 mm 5,3 mm
11-203 5,0 mm 6,0 mm
 Gall bladder trocars



11-204
PIERCE
Antrum trocar
4,0 mm



11-205
COAKLEY
Antrum trocar
3,0 mm

Vaginal specula



12-101
COLLIN
for children
53 x 10 mm

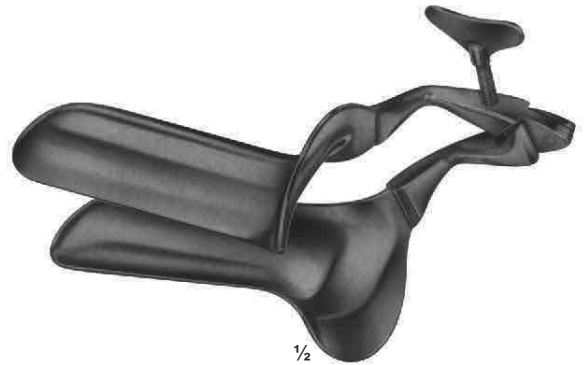

12-102 - 105
COLLIN

12-102	100/90mm	28 mm
12-103	100/90mm	32 mm
12-104	105/95mm	35 mm
12-105	115/105mm	40 mm

 Total length/working length width

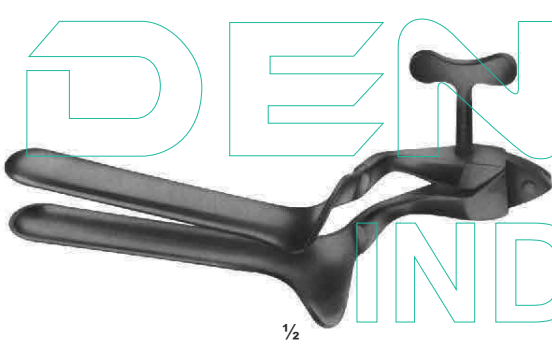

12-106
COLLIN
for virgins
95/85 x 18 mm

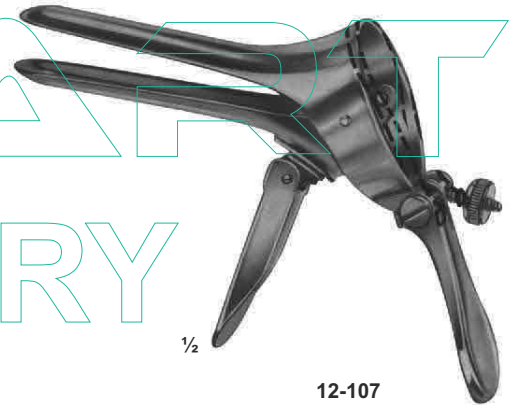

12-107
CUSCO
for virgins
75 x 17 mm



12-108
CUSCO
for virgins
75 x 17 mm

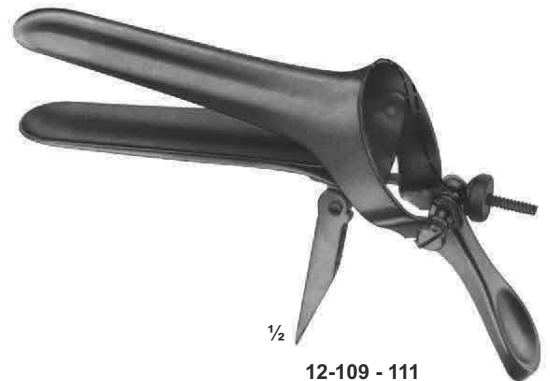

12-109 - 111
CUSCO

12-109	92X23-25 mm
12-110	100x25-27 mm
12-111	110x27-30 mm

Vaginal Specula



1/2

12-112 - 115
CUSCO
STANDARD
12-112 80X24 mm
12-113 80X32 mm
12-114 90X36 mm
12-115 110X37 mm



1/2

12-116 - 119
CUSCO
12-116 80X24 mm
12-117 80X32 mm
12-118 90X36 mm
12-119 110X37 mm

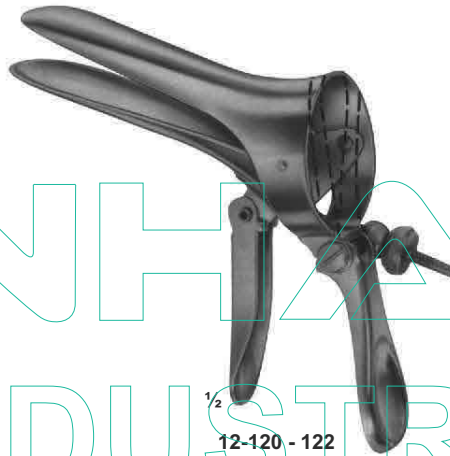

1/2

12-120 - 122
CUSCO
12-120 80X24 mm
12-121 80X32 mm
12-122 115X36 mm



1/2

12-123 - 124
SEYFFERT
12-123 100X24 mm
12-124 110X32 mm
230 mm



1/2

12-125
SEMM
for children
and virgins
180 mm

DENHART
INDUSTRY

Vaginal Specula, Sets, Upper & Lower Blades



12-126 - 128
GRAVE
12-126 75X20 mm
12-127 95X30 mm
12-128 105X33 mm



12-129 - 130
PEDERSON
12-129 100X22 mm
12-130 120X25 mm



12-131 - 132
BRIESKY
12-131 72X25 mm / 77X30 mm
12-132 75X30 mm / 92X38 mm
170 mm



12-133 - 134
BREISKY
12-133 100X22 mm
77 X30 mm
140 mm
12-134 120X25 mm
92 X38 mm



12-135 - 137
SEIDL
12-135 80X8 mm
12-136 80X10 mm
12-137 90X14 mm
For children and infants
170 mm



12-138
KRISTELLER
70X15 mm, (170 mm)
For children



12-139 - 141
SIMS
12-139 70X26 mm
75 X30 mm 125 mm
12-140 75X30 mm
80 X85 mm 150 mm
11-141 80X36 mm
90 X40 mm 175 mm

Vaginal Specula-Sets, upper and lower blades

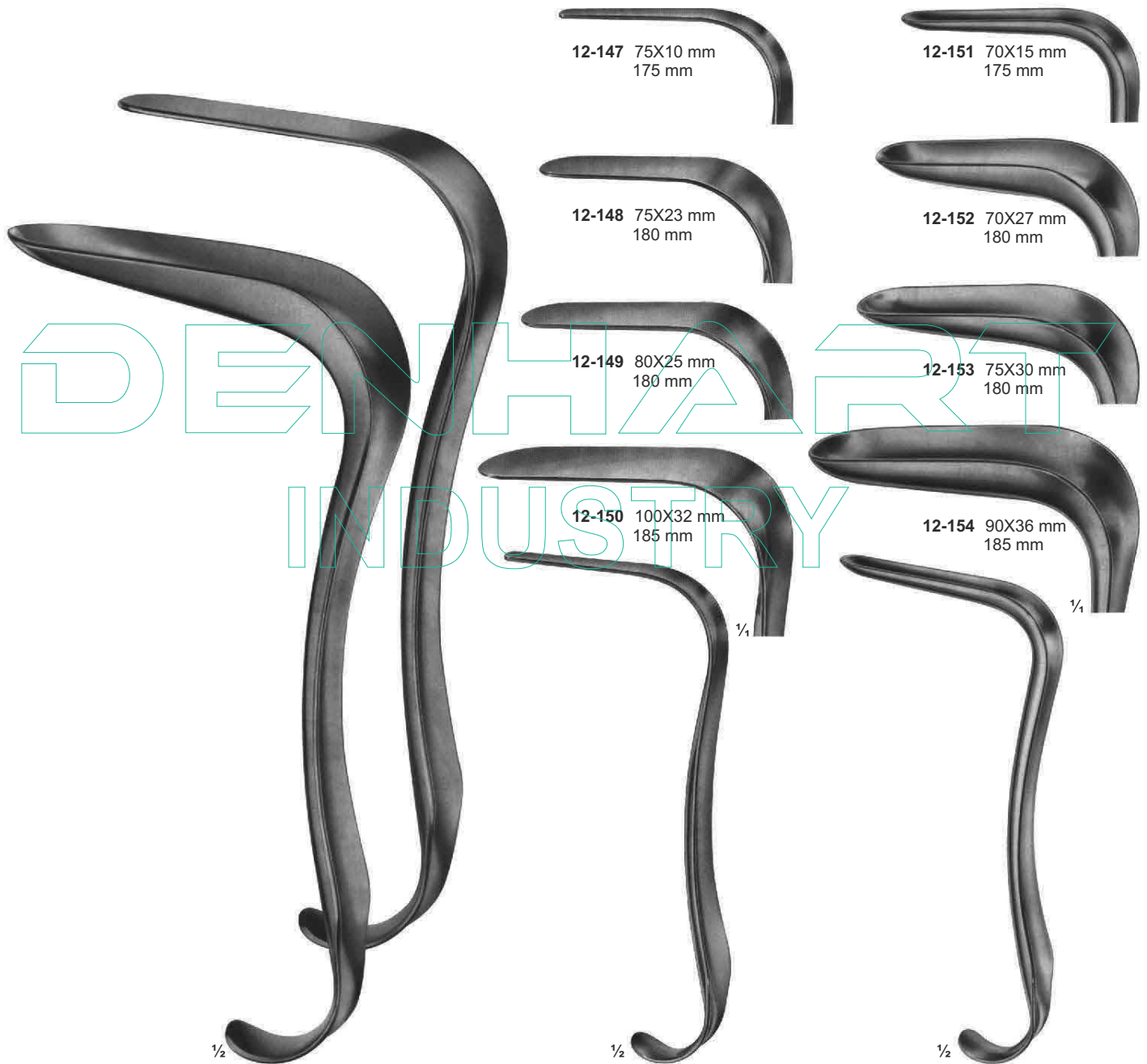

12-142 - 146
KRISTELLER
12-142 110X18 mm
12-143 110X20 mm
12-144 110X27 mm
12-145 110X30 mm
12-146 110X36 mm
220 mm

12-147 - 150
KRISTELLER
Upper blades
12-147 75X10 mm
175 mm
12-148 75X23 mm
180 mm
12-149 80X25 mm
180 mm
12-150 100X32 mm
185 mm

12-151 - 154
KRISTELLER
Lower blades
12-151 70X15 mm
175 mm
12-152 70X27 mm
180 mm
12-153 75X30 mm
180 mm
12-154 90X36 mm
185 mm

Vaginal Specula-upper and lower blades



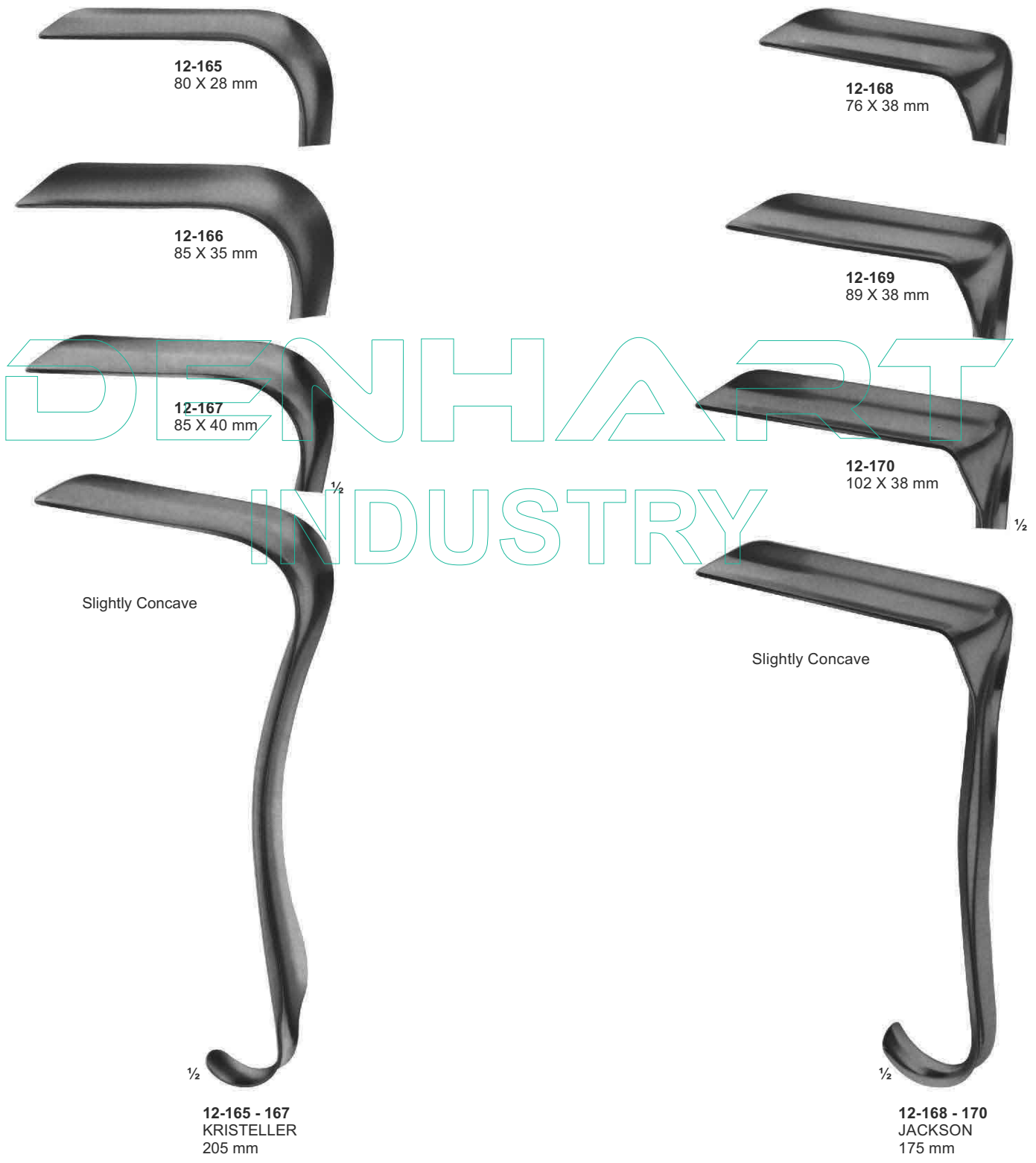

Vaginal Specula-for children & virgins / Vario Retractor



56 x 13 mm

1/2

12-171
BRAUN
180 mm

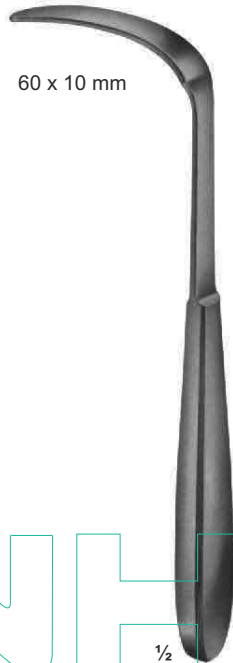

60 x 10 mm

1/2

12-172
BRAUN
180 mm



95 x 17 - 30 mm

1/2

12-173
MATHIEU
For children
and virgins
210 mm



95 x 17-26 mm

1/2

12-174
MATHIEU
for children and
virgins fitting
210 mm



12-175
Handle with cold light
carrier for upper blades
280 mm

1/2

DENHART
INDUSTRY

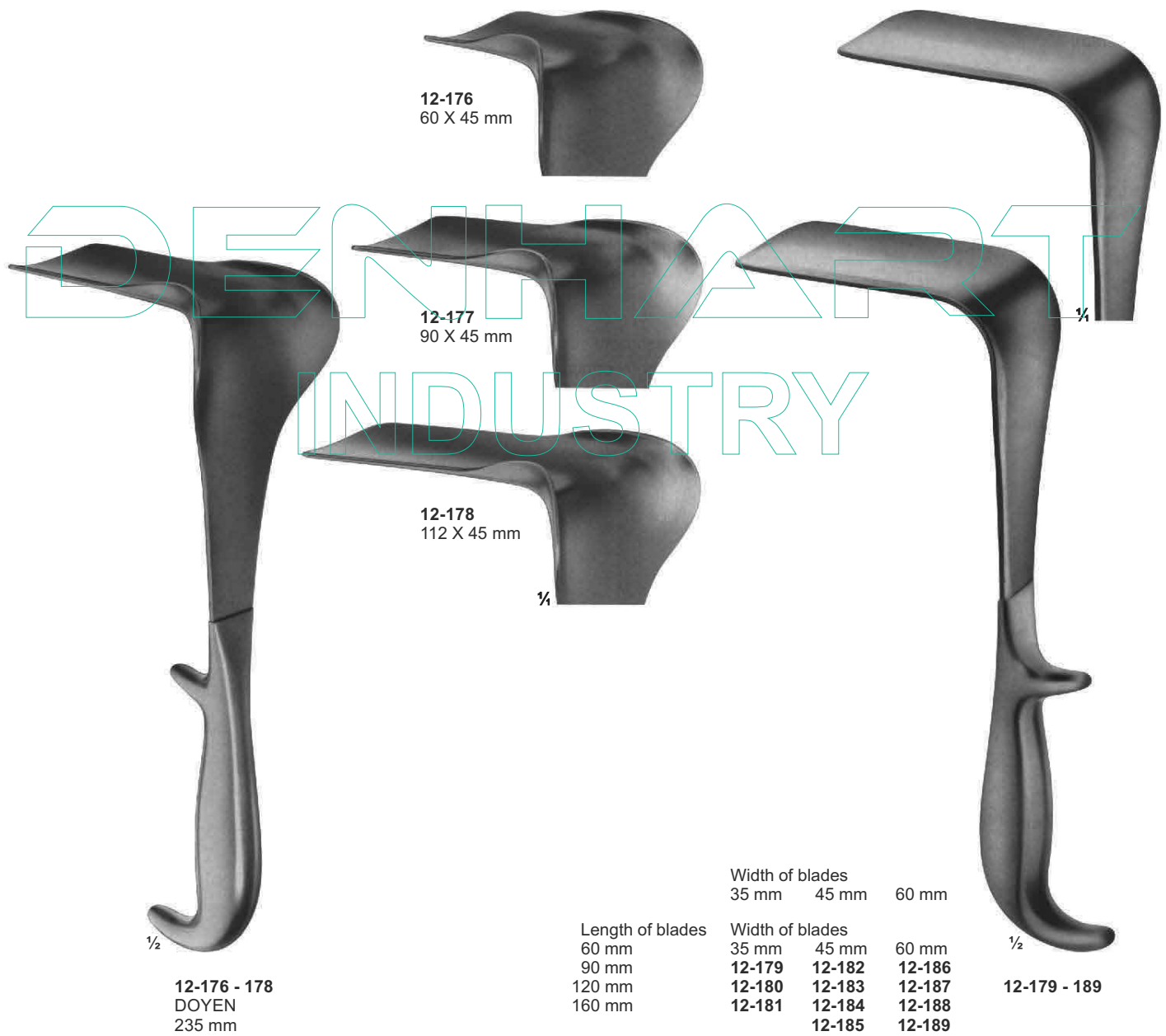

1/2
12-176 - 178
 DOYEN
 235 mm

Length of blades
 60 mm
 90 mm
 120 mm
 160 mm

Width of blades		
35 mm	45 mm	60 mm
Width of blades		
35 mm	45 mm	60 mm
12-179	12-182	12-186
12-180	12-183	12-187
12-181	12-184	12-188
	12-185	12-189

1/2
12-179 - 189



12-190 - 194
BREISKY
WIENER MODELL/
VIENNA PATTERN
12-190 100 X 20 mm
12-191 100 X 25 mm
12-192 100 X 30 mm
12-193 100 X 35 mm
12-194 100 X 40 mm
300 mm

12-195 - 199
BREISKY
WIENER MODELL/
VIENNA PATTERN
12-195 130 X 20 mm
12-196 130 X 25 mm
12-197 130 X 30 mm
12-198 130 X 35 mm
12-199 130 X 40 mm
320 mm

12-200 - 201
WEISSBARTH
12-200 80 X 28 mm
12-201 85 X 42 mm
210 mm

12-202
DOYEN
lateral speculum
80 x 30 mm
250 mm

Vaginal & Wound Retractor / Vaginal Specula



12-203
SIMON
115 X 22 mm
275 mm

DENHART
INDUSTRY



12-204
AUVARD
65 X 38 mm - 28 mm
1,530 kg
with fixed weight
230 mm



12-205 - 206
AUVARD
12-205 75 X 42 mm
(40 mm)
12-206 105 X 43 mm
(40 mm)
with detachable wight
230 mm



12-207
MARTIN
with hook shaped
handle for hanging
in weights
270 mm

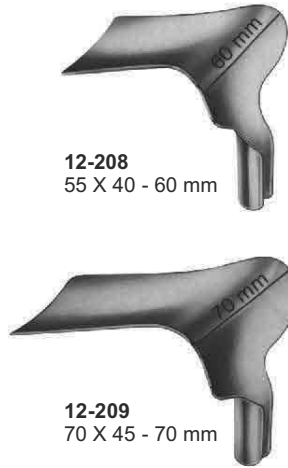
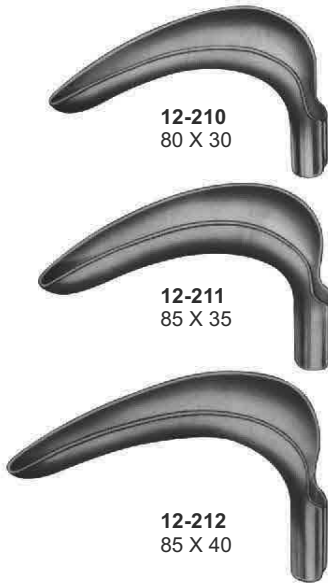

DENHART
INDUSTRY



12-213 - 220
SCHERBACK
Set consisting of:
2 handle
8 blades

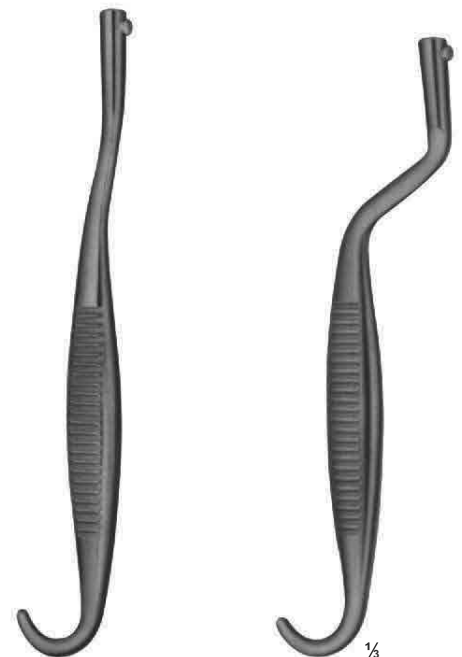

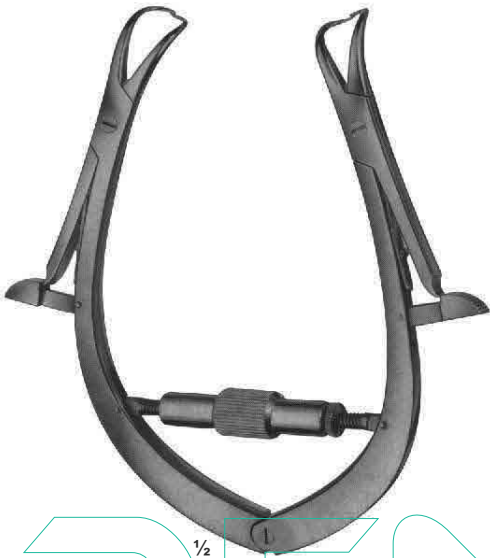

12-221
JOLL (FRIEDMAN)
155 mm



12-222
RICHTER
170 mm

DENHART
INDUSTRY

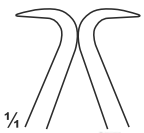

12-223
GELPI
135 mm

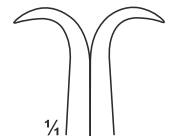

12-224
GELPI
175 mm



13-101	1	mm	13-123	23	mm
13-102	2	mm	13-124	24	mm
13-103	3	mm	13-125	25	mm
13-104	4	mm	13-126	26	mm
13-105	5	mm	13-127	1	½mm
13-106	6	mm	13-128	2	½mm
13-107	7	mm	13-129	3	½mm
13-108	8	mm	13-130	4	½mm
13-109	9	mm	13-131	5	½mm
13-110	10	mm	13-132	6	½mm
13-111	11	mm	13-133	7	½mm
13-112	12	mm	13-134	8	½mm
13-113	13	mm	13-135	9	½mm
13-114	14	mm	13-136	10	½mm
13-115	15	mm	13-137	11	½mm
13-116	16	mm	13-138	12	½mm
13-117	17	mm	13-139	13	½mm
13-118	18	mm	13-140	14	½mm
13-119	19	mm	13-141	15	½mm
13-120	20	mm	13-142	16	½mm
13-121	21	mm	13-143	17	½mm
13-122	22	mm			

DENHART

INDUSTRY

13-101 - 143
HEGAR
with very conical point
185 mm



13-144	1+2	mm
13-145	3+4	mm
13-146	5+6	mm
13-147	7+8	mm
13-148	9+10	mm
13-149	11+12	mm
13-150	13+14	mm
13-151	15+16	mm
13-152	17+18	mm

13-144 - 152
HEGAR
205 mm

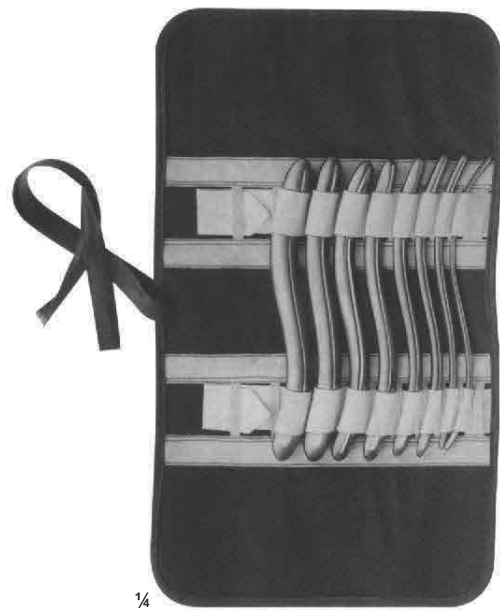

13-153
HEGAR
Uterine dilator set, in canvas
roll with 8 dilators.

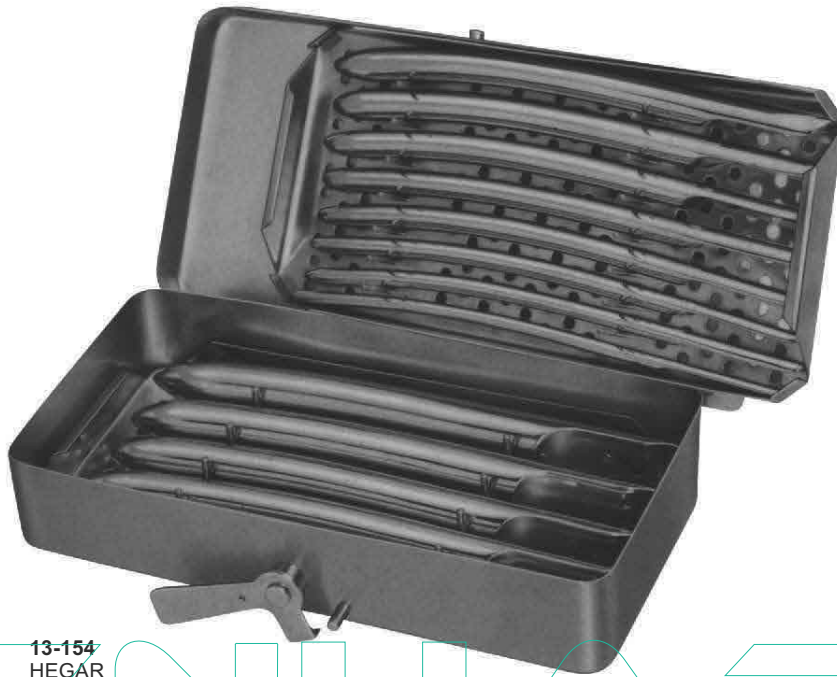

13-154
HEGAR
Dilator set consisting of:
14 Dilators,
1 Rack for dilators (4 - 12 mm)
1 Rack for Dilators (13 - 17 mm)
1 Metal case only,
with hinged lid, stainless 200 X 100 X 35 mm

DENHART
INDUSTRY

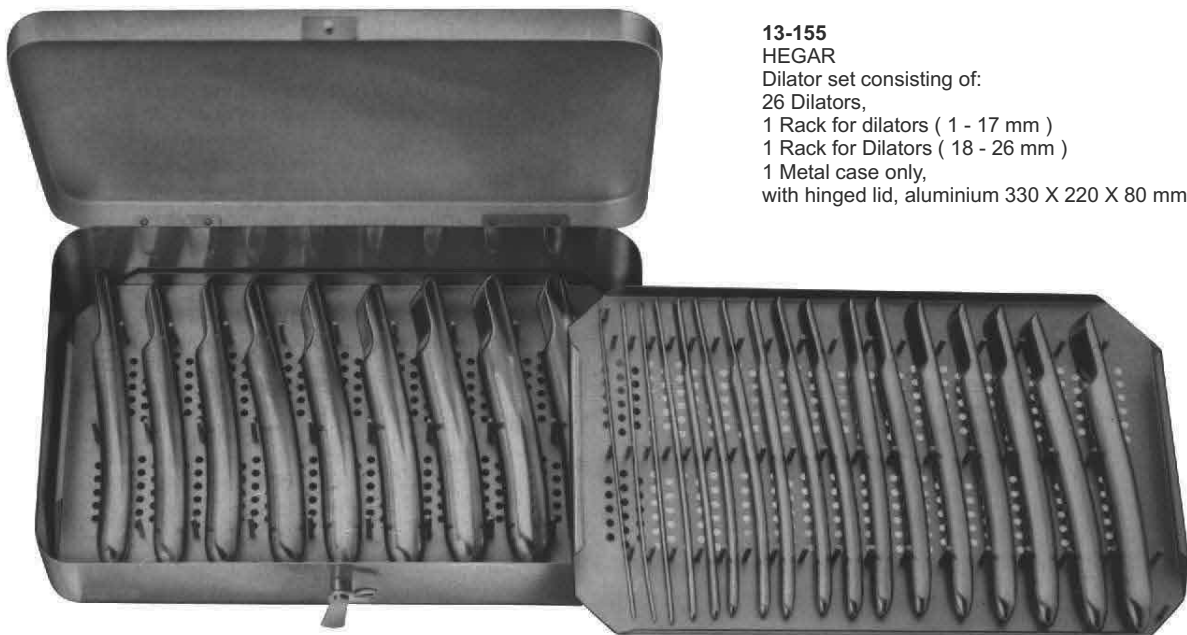

13-155
HEGAR
Dilator set consisting of:
26 Dilators,
1 Rack for dilators (1 - 17 mm)
1 Rack for Dilators (18 - 26 mm)
1 Metal case only,
with hinged lid, aluminium 330 X 220 X 80 mm

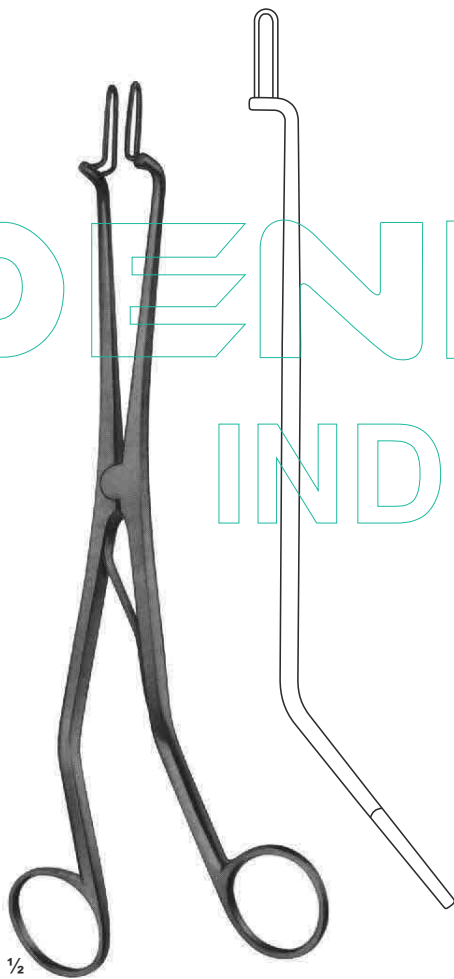

13-156
KOGAN
Endospecula for cervix
and urethra, without ratchet
240 mm

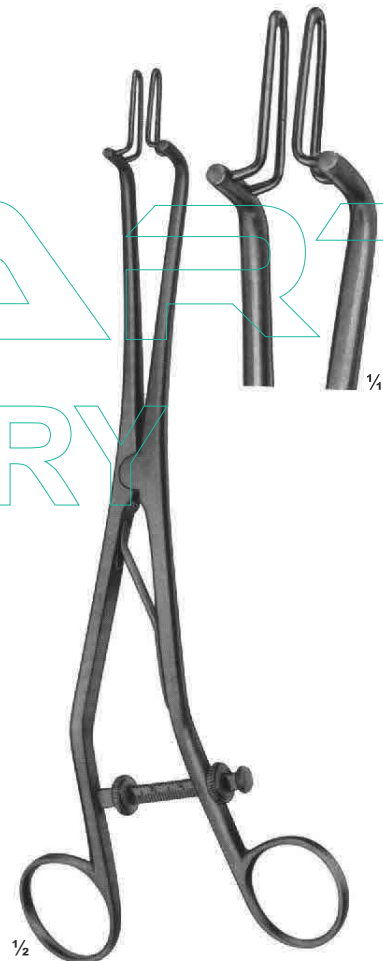

13-157
KOGAN
Endospecula for cervix
and urethra, with
scale-ratchet and fixing screws
240 mm

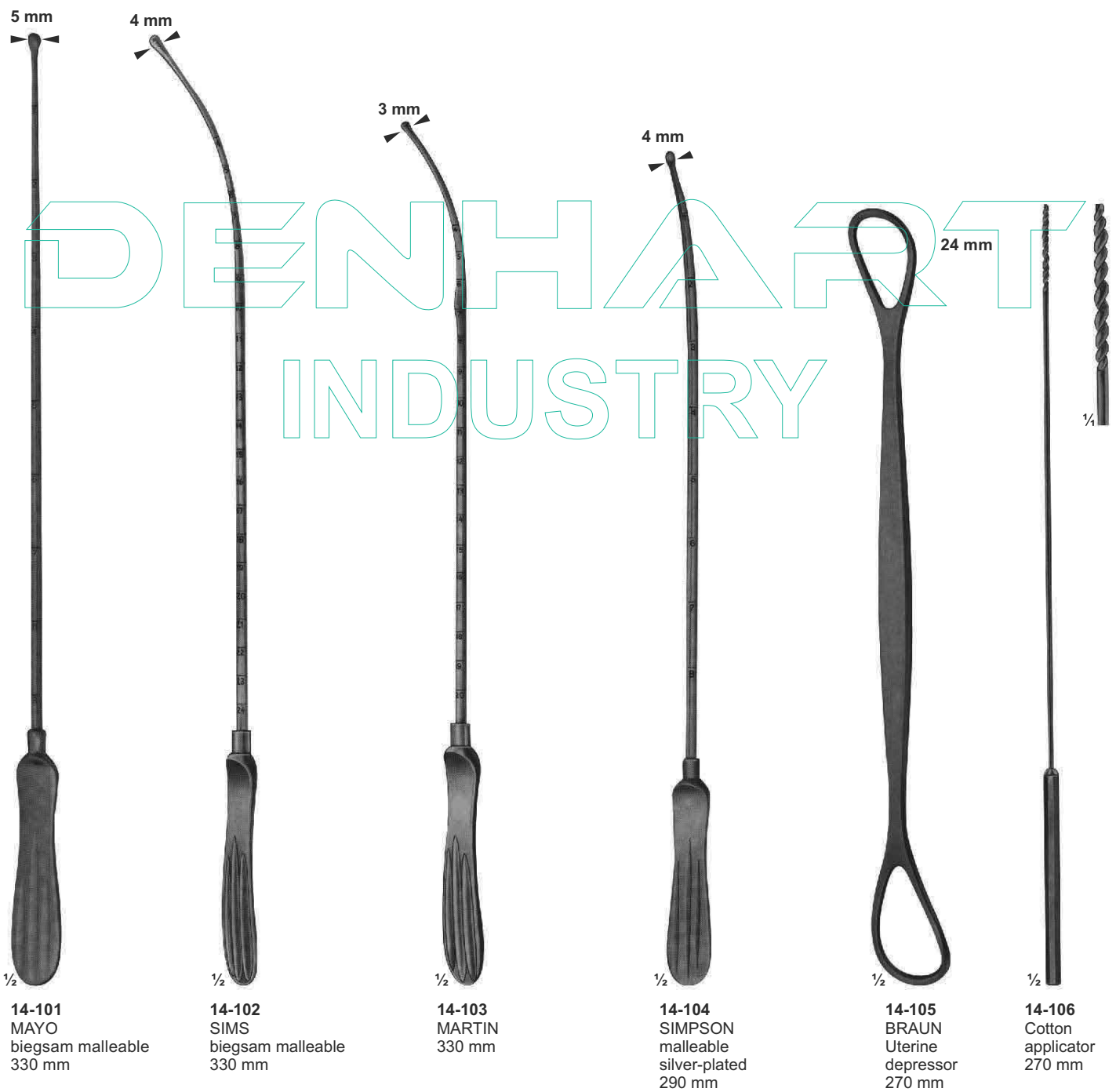

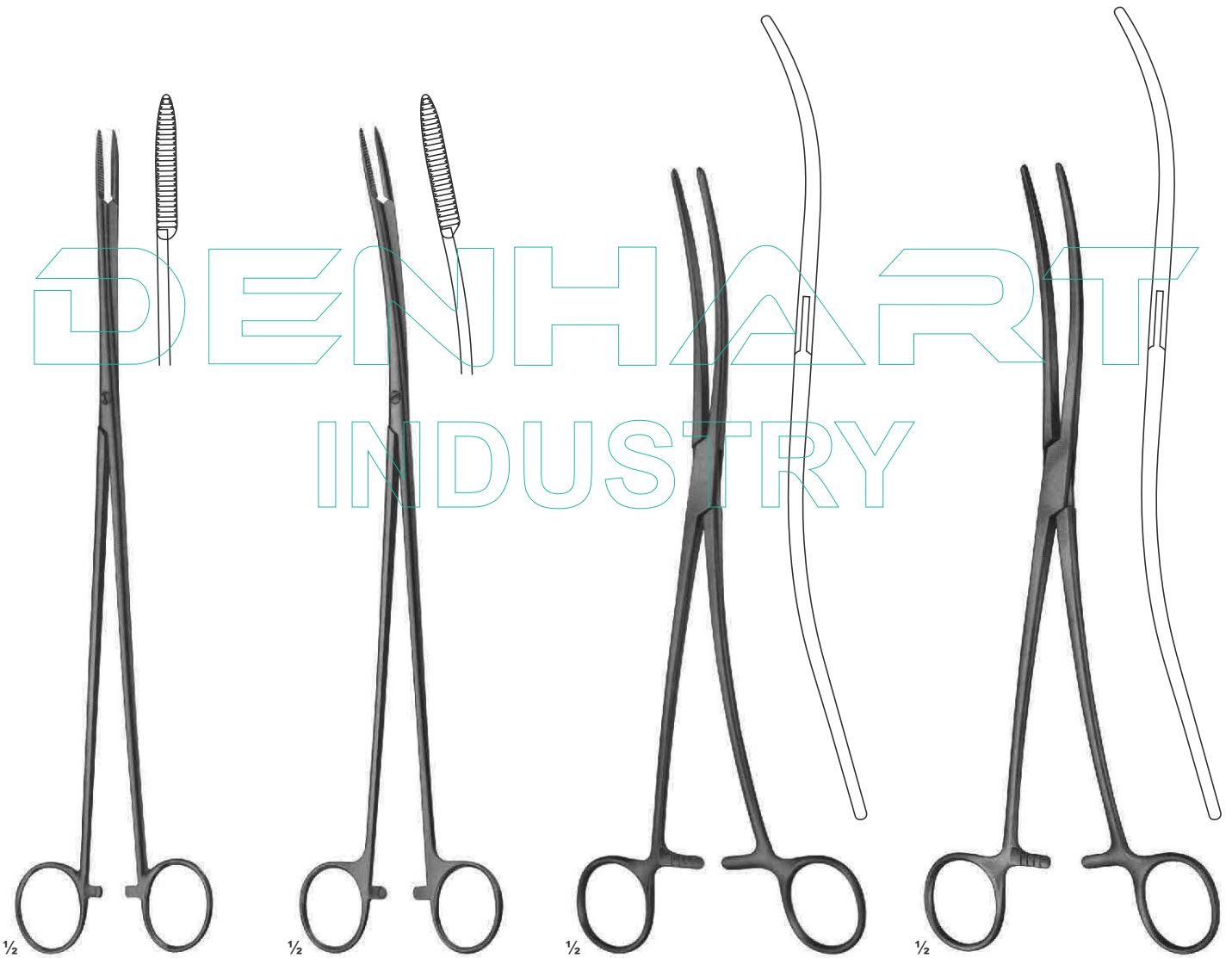

1/2
14-107
PELKMANN
260 mm

1/2
14-108
PELKMANN
260 mm

1/2
14-109
BOZEMANN
250 mm

1/2
14-110
BOZEMANN
255 mm

Jaws with longitudinal groove

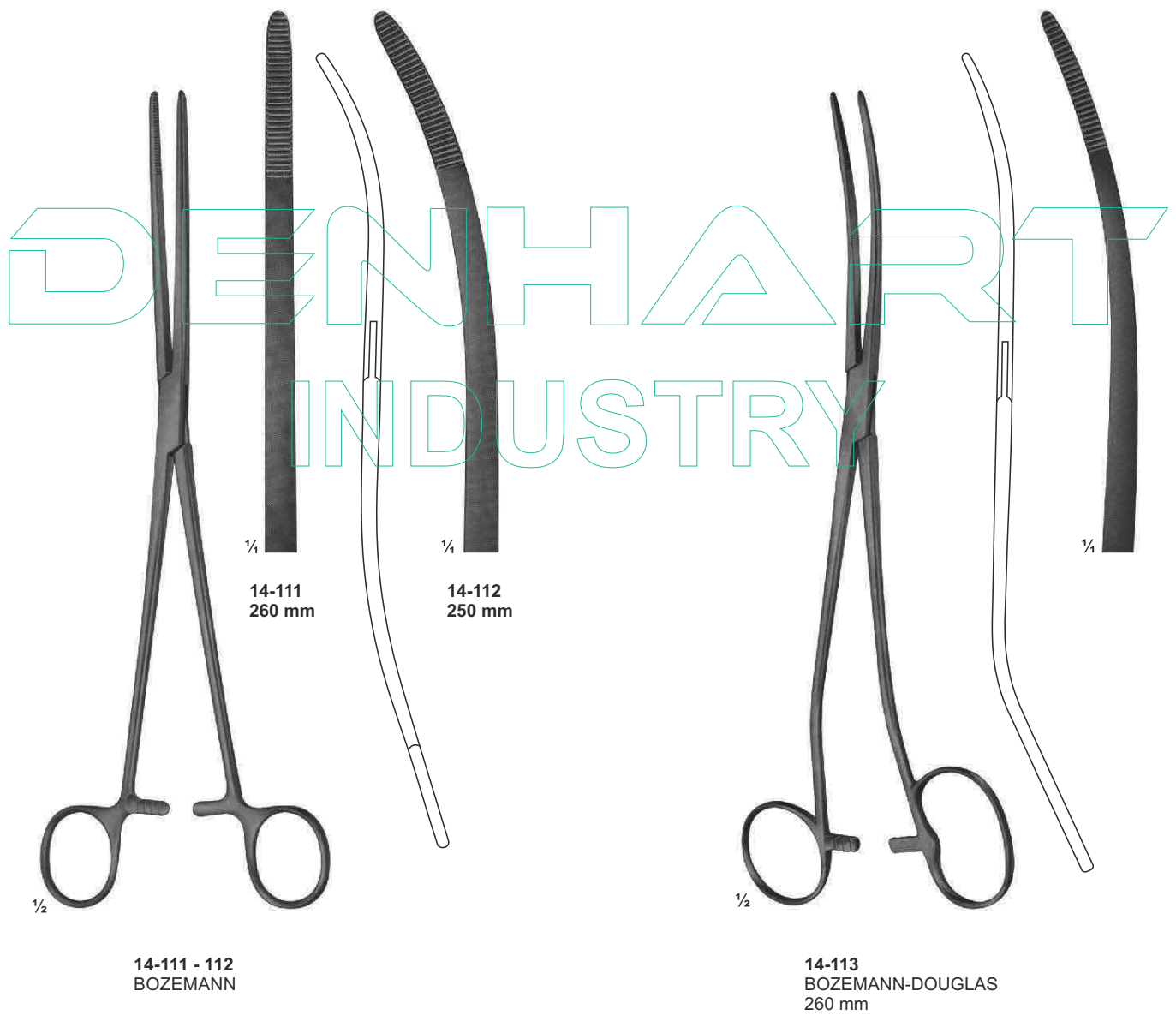

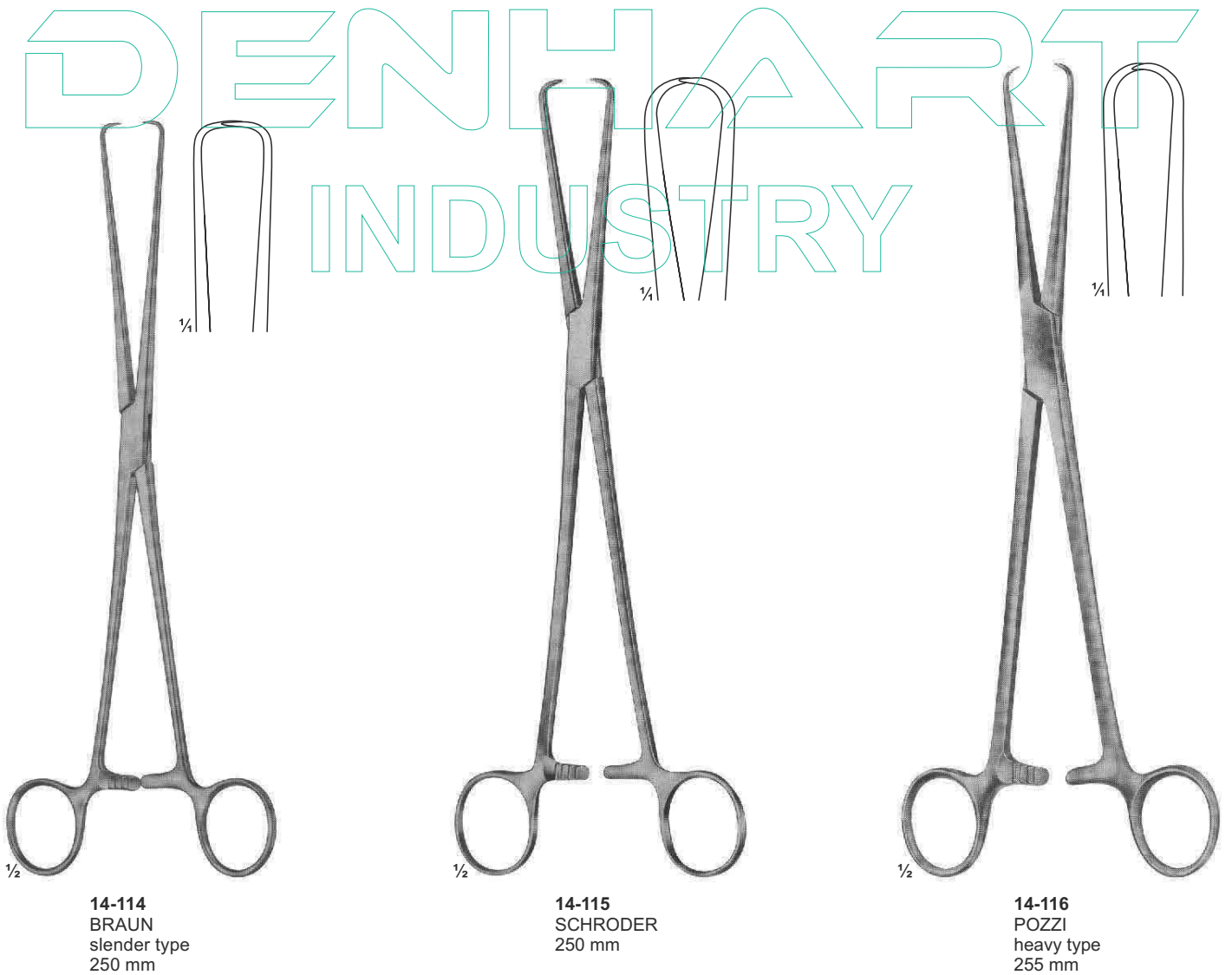

14-114
BRAUN
slender type
250 mm

14-115
SCHRODER
250 mm

14-116
POZZI
heavy type
255 mm

Uterine Tenaculum Forceps



14-117
265 mm

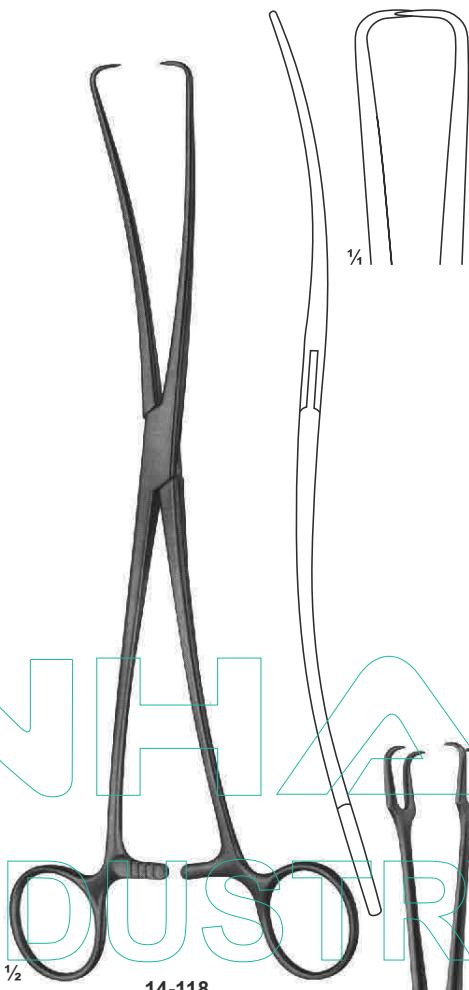

14-118
DUPLAY
250 mm

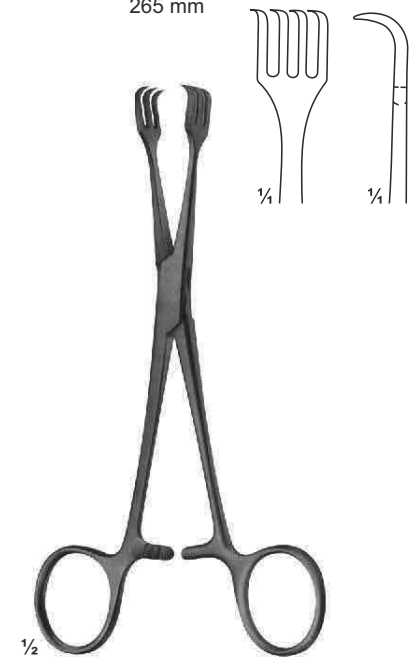

14-119
LAHEY
155 mm



14-120
straight

14-121
curved
on flat

14-122
curved
sideways

14-120 - 122
SCHRODER
250 mm

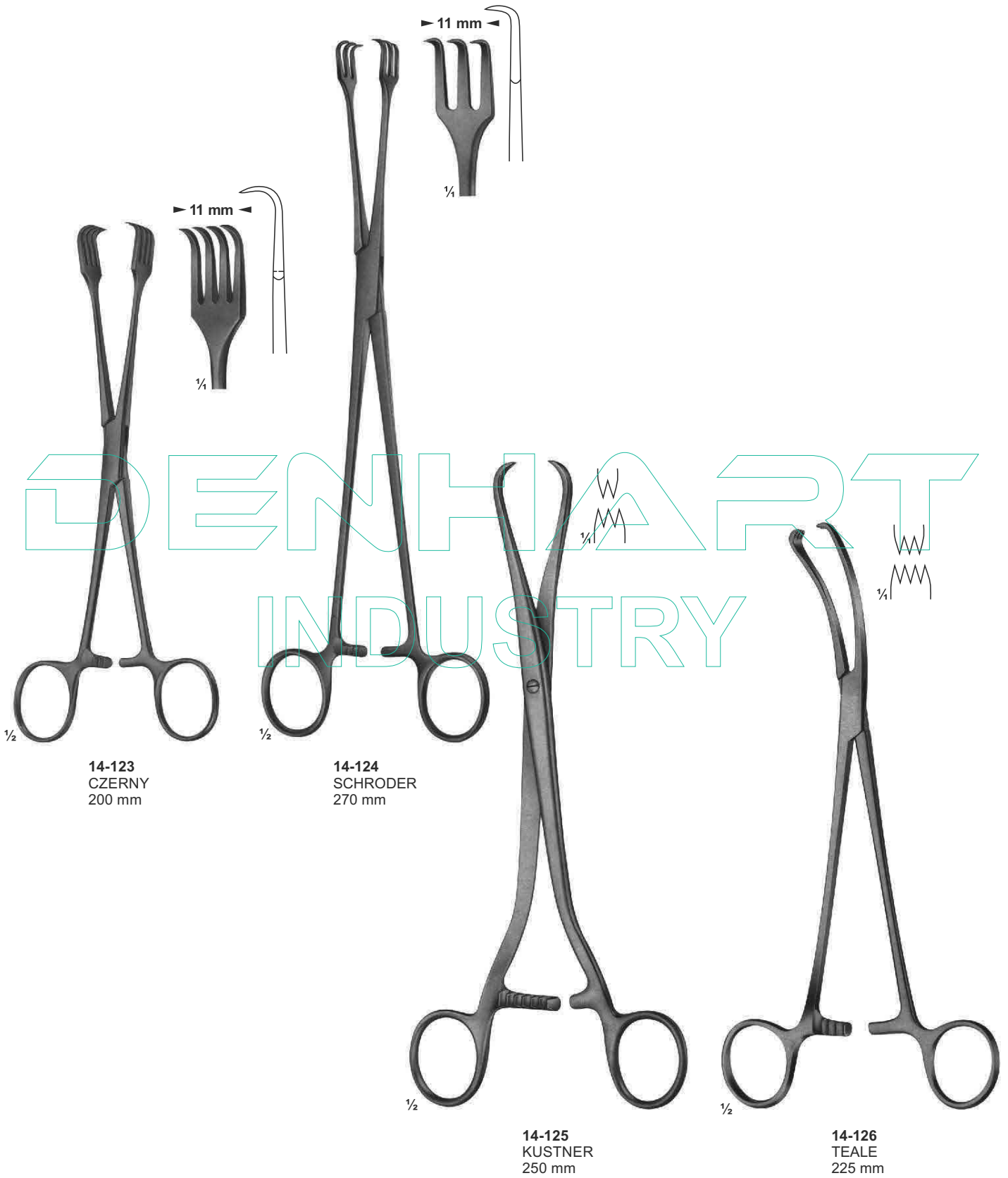



14-127
JACOBS
215 mm



14-128
LITTLEWOOD
185 mm



14-129
MUSEUX
200 mm

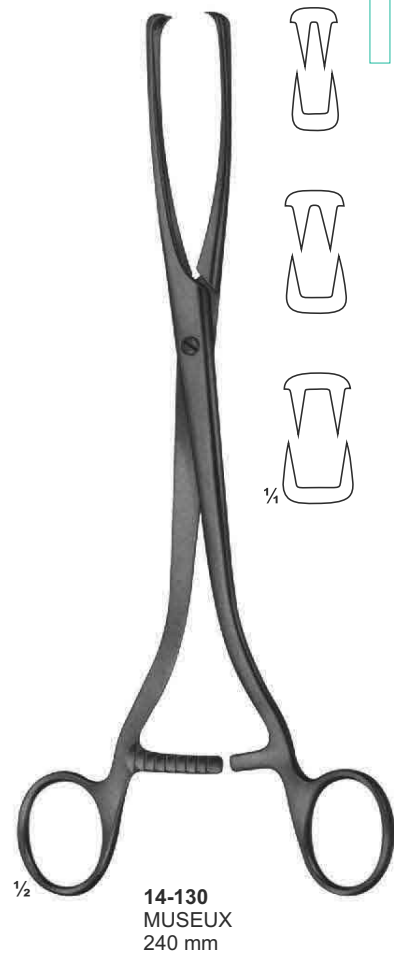

14-130
MUSEUX
240 mm

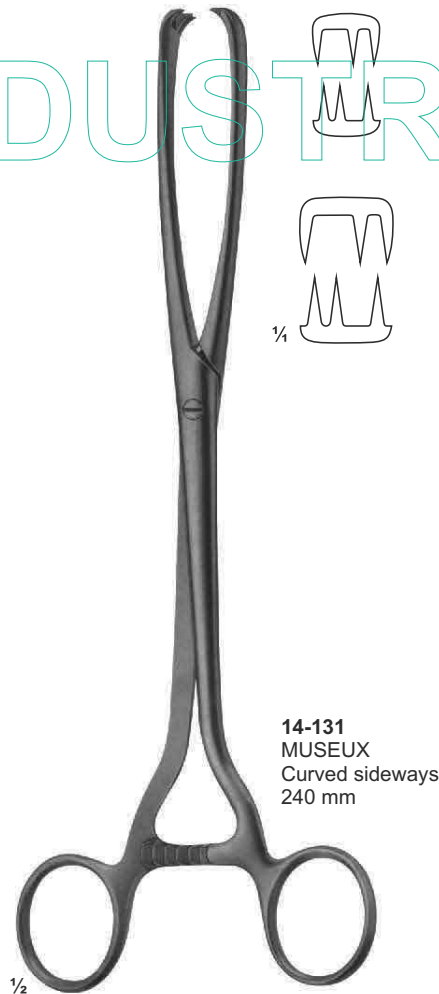

14-131
MUSEUX
Curved sideways
240 mm

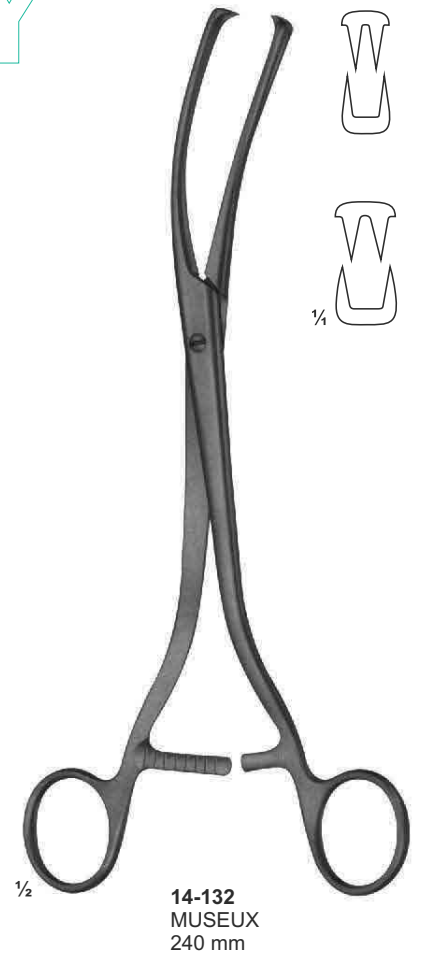

14-132
MUSEUX
240 mm

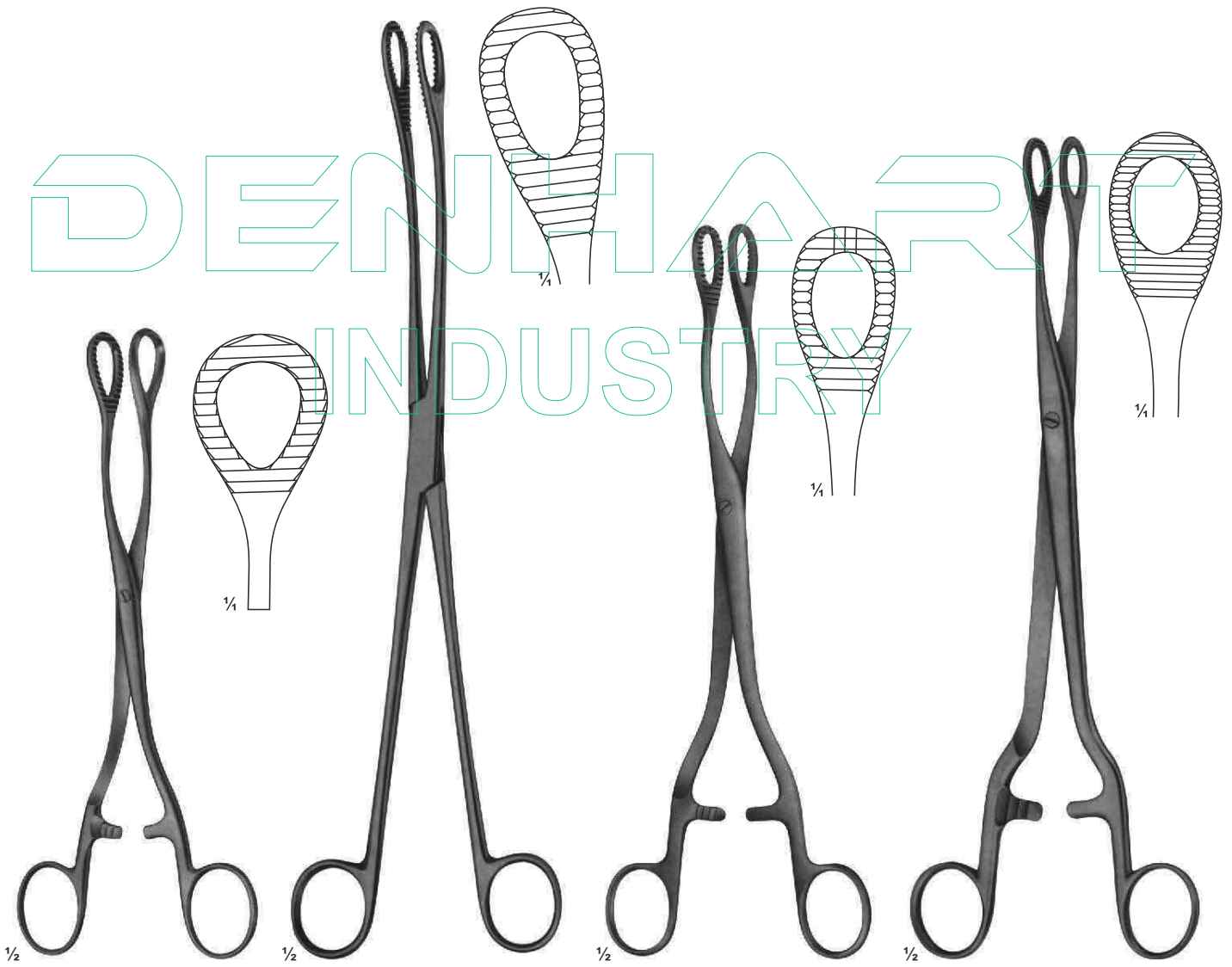

14-133
HEYWOOD-SMITH
200 mm

14-134
KELLY
320 mm

14-135
HEYWOOD-SMITH
250 mm

14-136
NOTO
280 mm



1/4



1/4

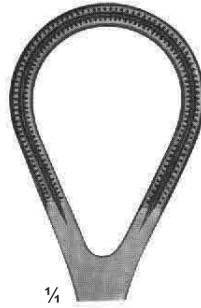

1/4



1/4

14-138

14-139

DENHART
INDUSTRY



1/2

14-137
DOYEN
185 mm

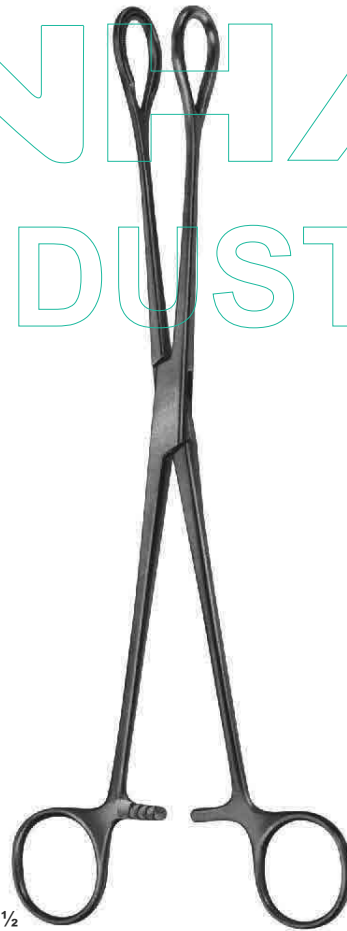

1/2

14-138 - 139
250 mm 270 mm



1/2

14-140
BUMM
280 mm

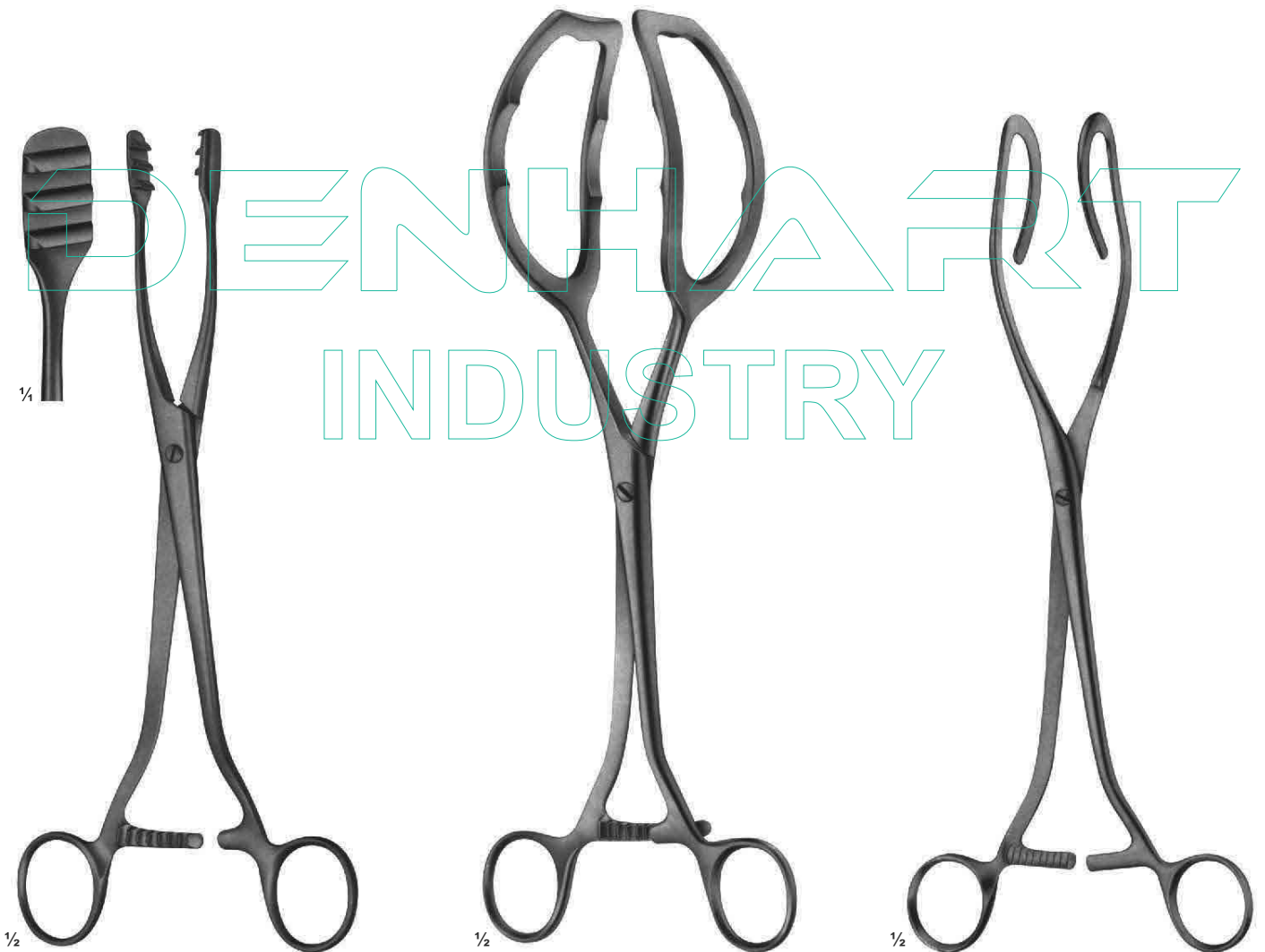

14-141
COLLIN
250 mm

14-142
COLLIN
285 mm

14-143
DARTIGUES
255 mm

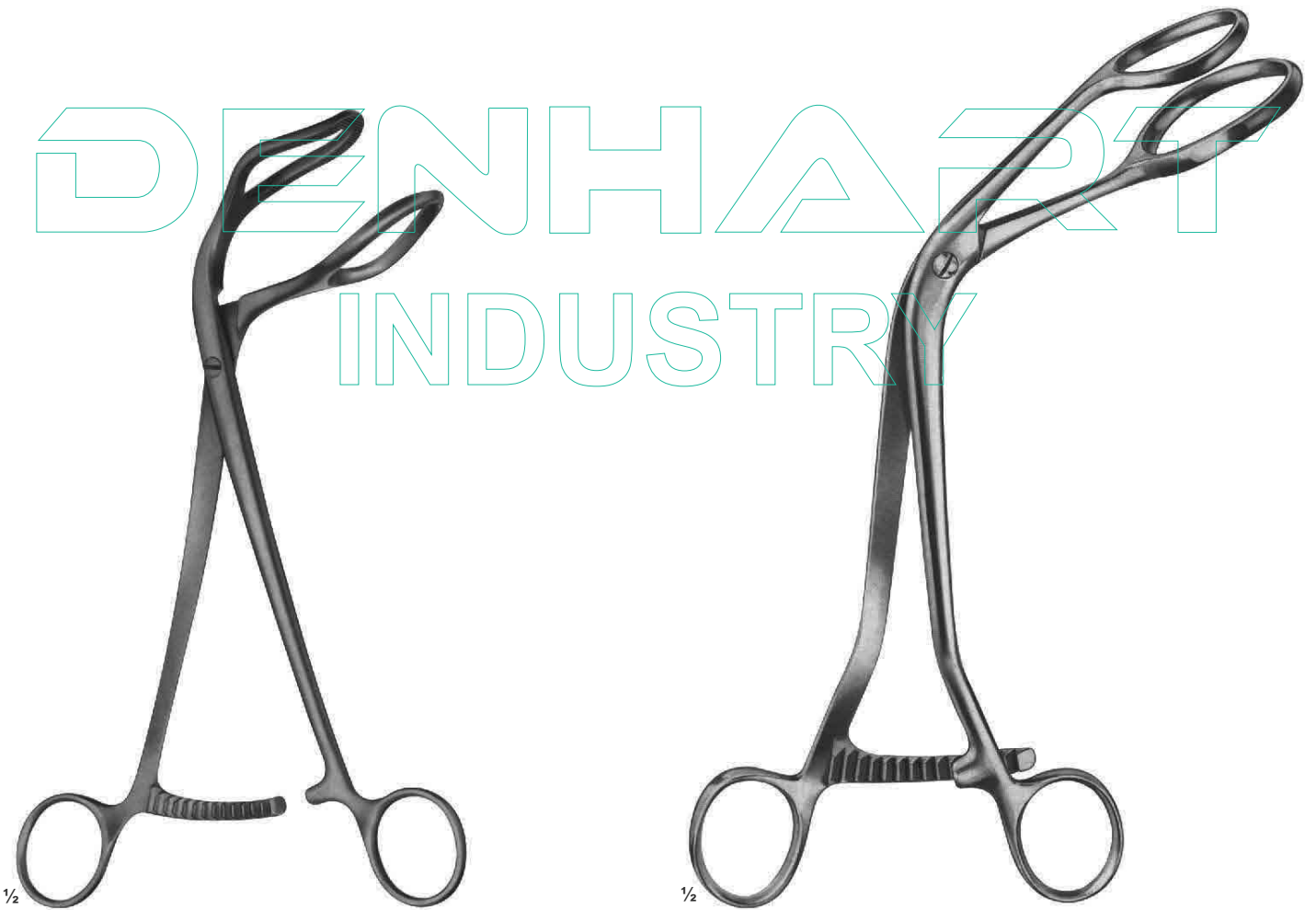

14-144
SOMER
235 mm

14-145
STRASSMANN
260 mm

With movable jaws



14-146
COLLIN
265 mm

With movable jaws

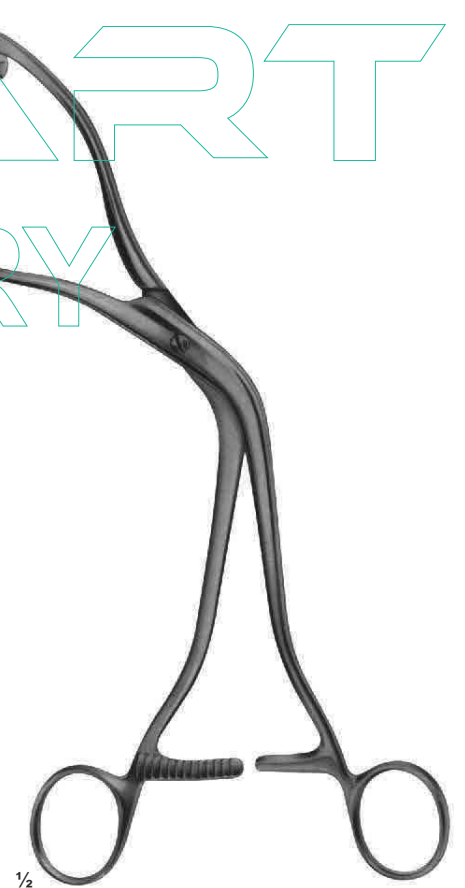
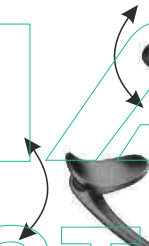

14-147
260 mm



14-148
SEGOND
Myomatome
270 mm



14-149
DOYEN
Myoma screw
150 mm



14-150
DOYEN
Myoma screw
190 mm

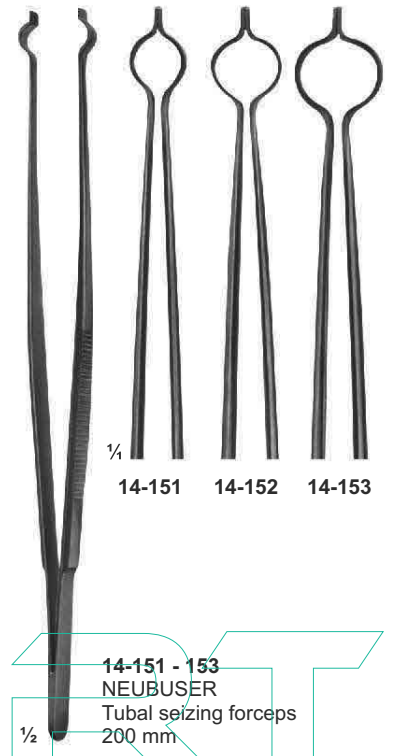

14-151 14-152 14-153

14-151 - 153
NEUBUSER
Tubal seizing forceps
200 mm

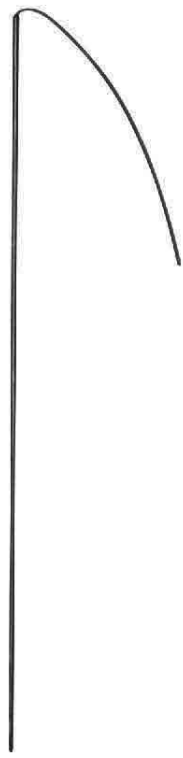

14-154
Splint guide
with thread



14-155
Splint guide with
round handle
180 mm



14-156
Angled glass rods
Set . 3 pieces

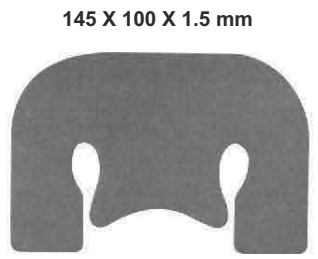

145 X 100 X 1.5 mm

14-157
Silicon operating pad
pre-cut



14-158
Polyaethylen splint material
soft-sterile
0.45 mm

DENHART
INDUSTRY

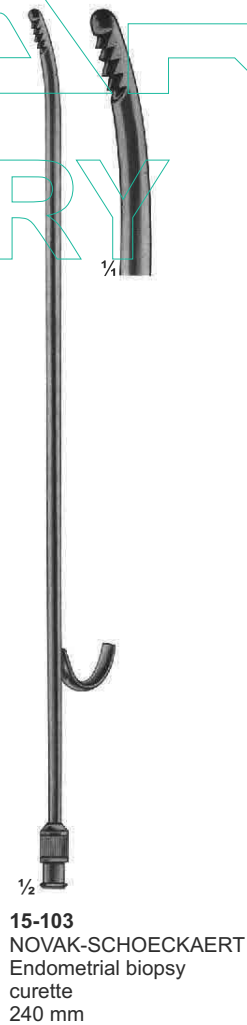

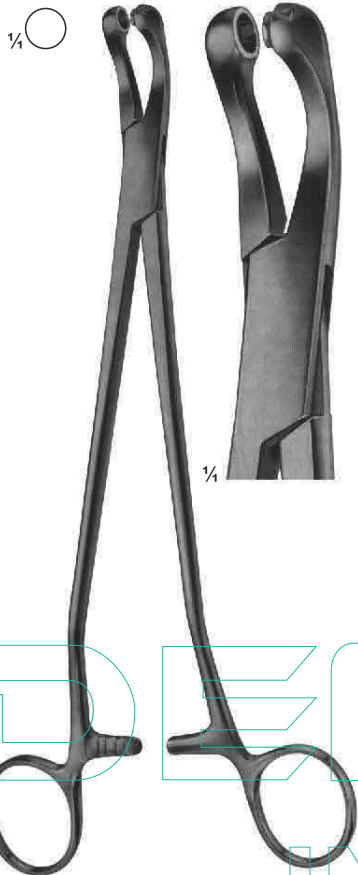

15-105
THOMS-GAYLOR
240 mm

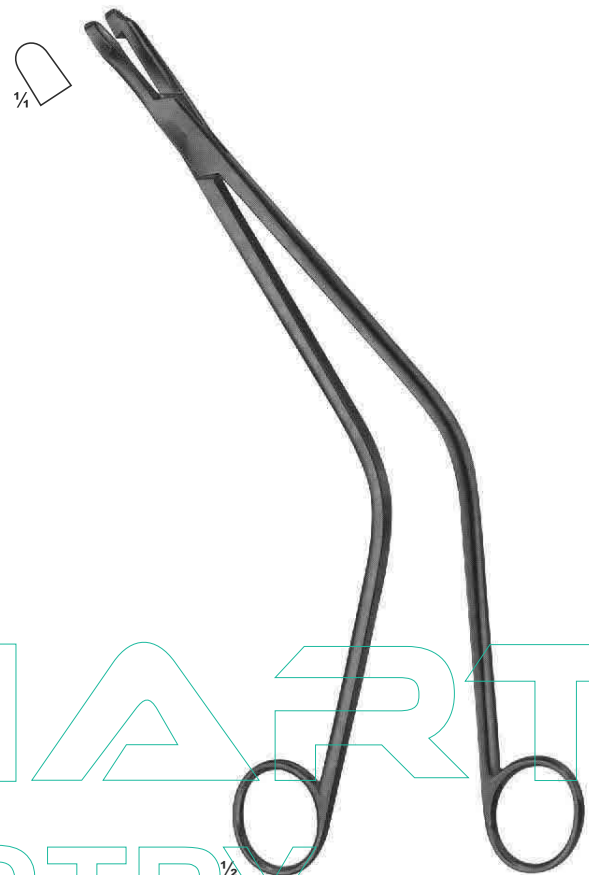

15-106
SCHUBERT
260 mm

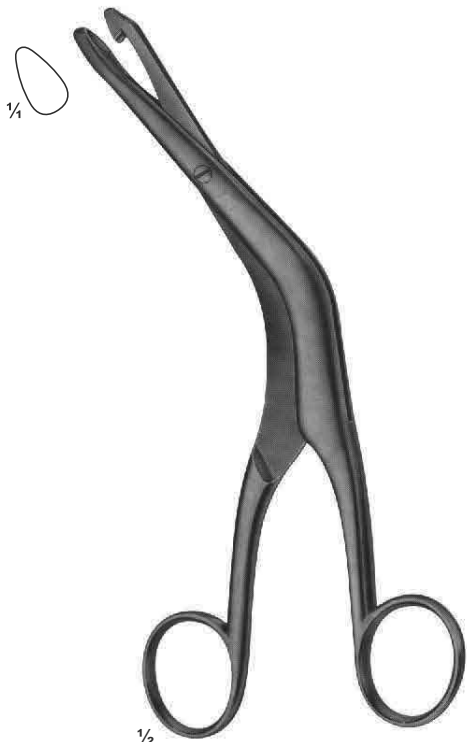

15-107
FAURE
210 mm

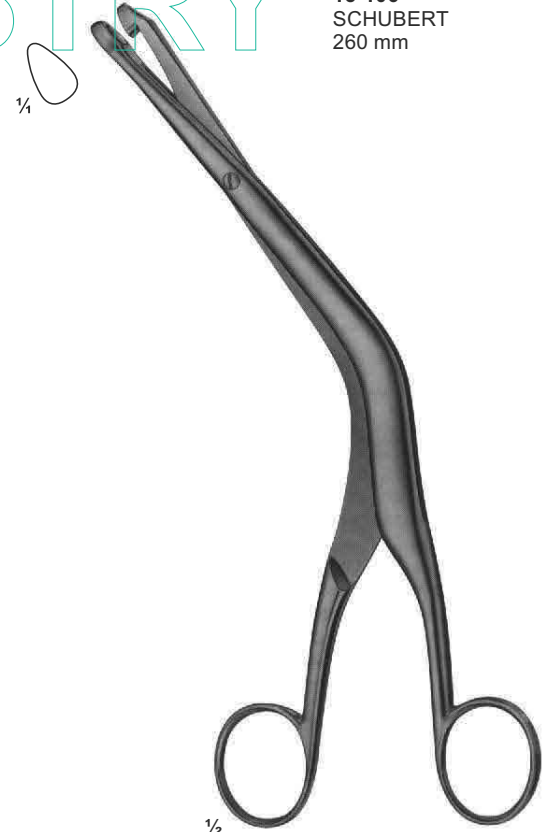

15-108
FAURE
240 mm

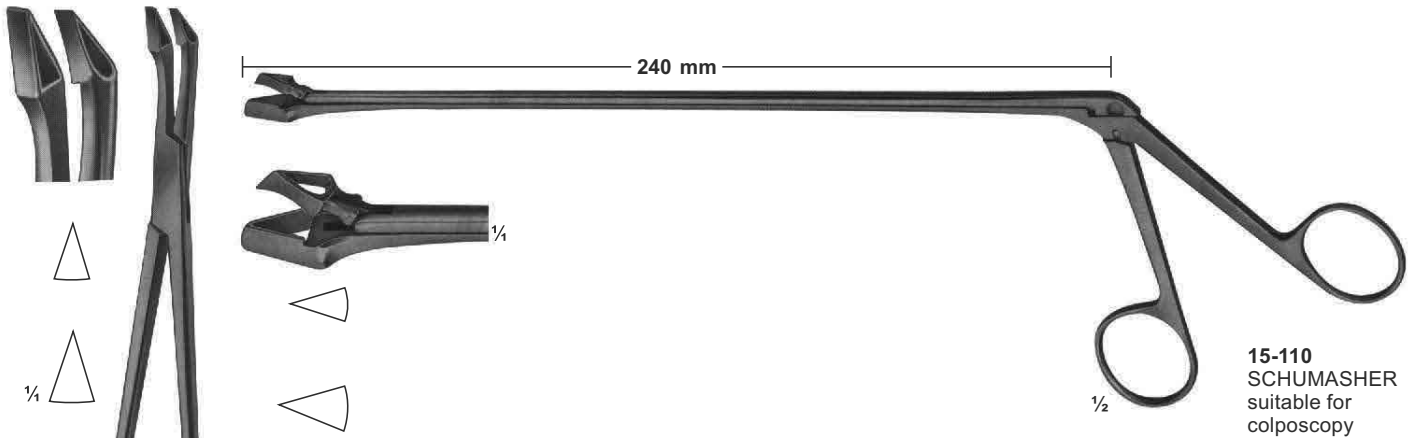

15-109
SCHUMASHER
240mm

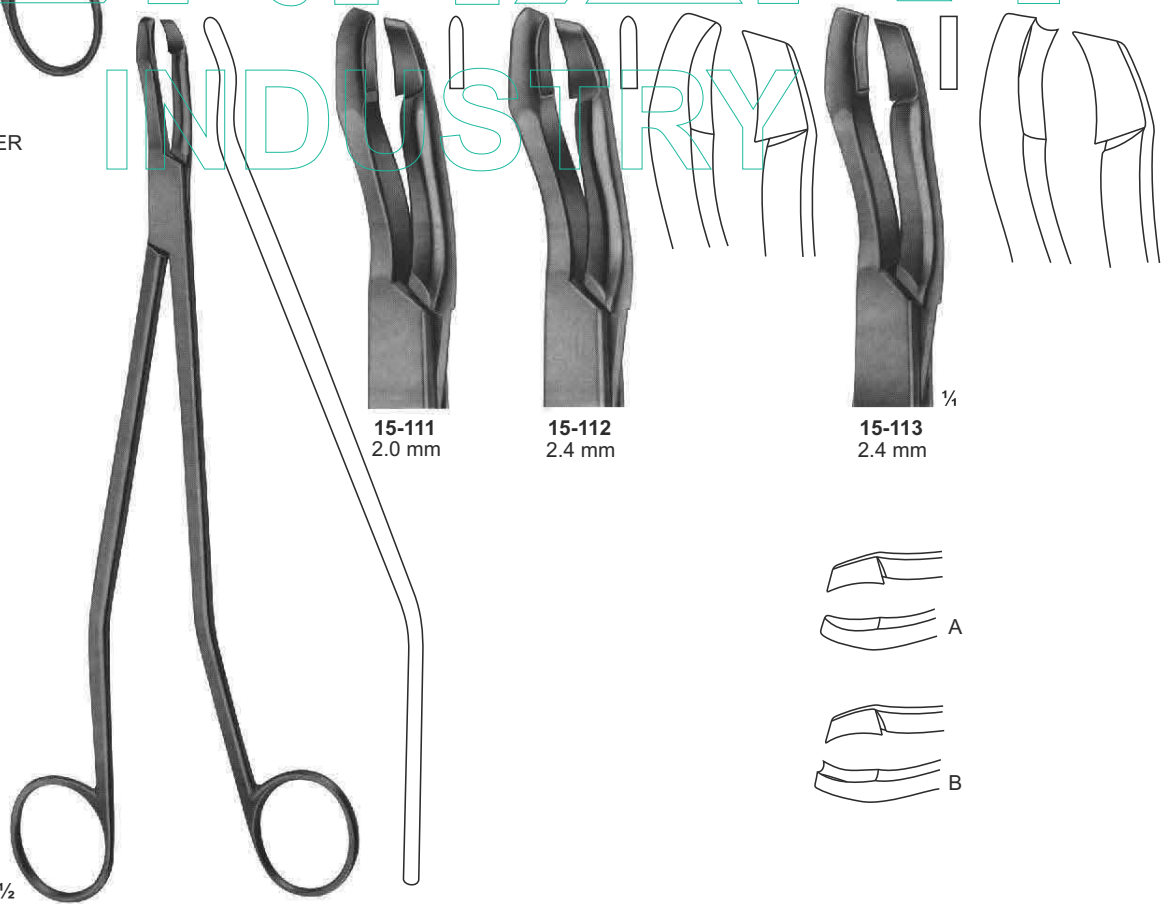

15-111 - 113
SEIDL DBP
Biopsy forceps, bayonet shaped
for portio, vagina and vulva
240mm

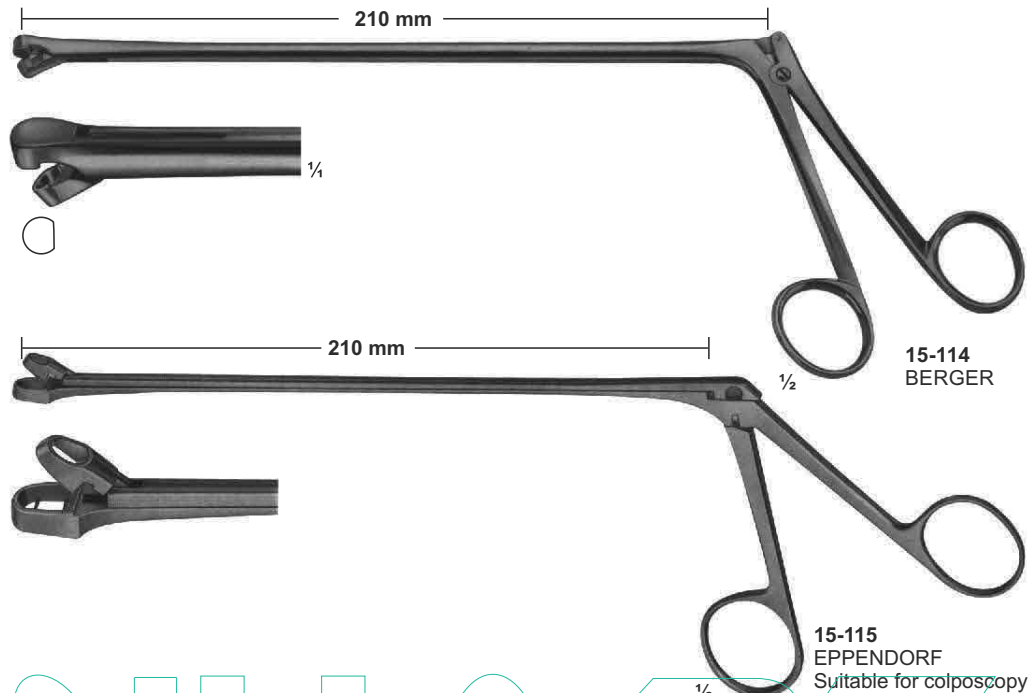

15-114
BERGER

15-115
EPPENDORF
Suitable for colposcopy

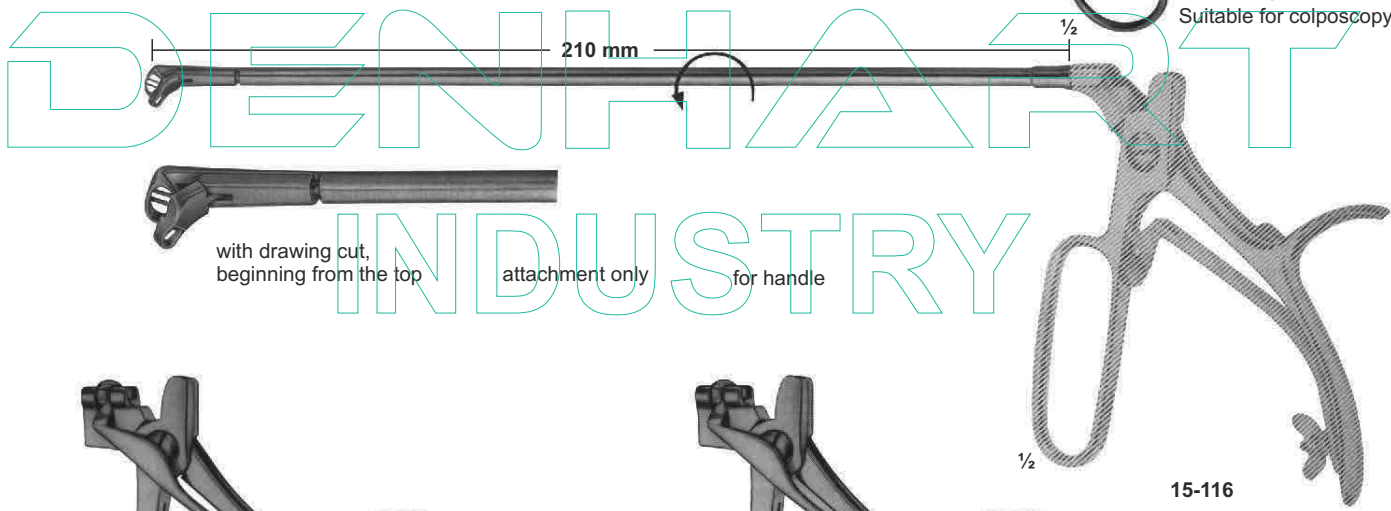

with drawing cut, beginning from the top attachment only for handle

15-116



15-117
140 mm

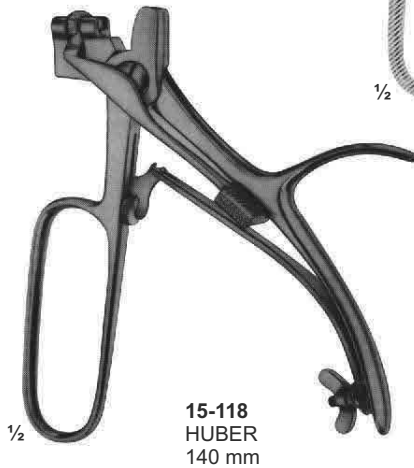

15-118
HUBER
140 mm



Extension cannulae

15-119 BRUENINGS 200 mm Length
15-120 BRUENINGS 250 mm Length



15-121 KRAUSE (Biopsy tip)

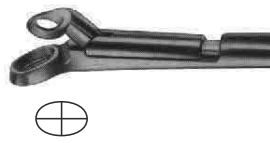

15-122 SCHEINMANN (Biopsy tip)



15-123 SCHEINMANN (Biopsy tip)
with drawing cut

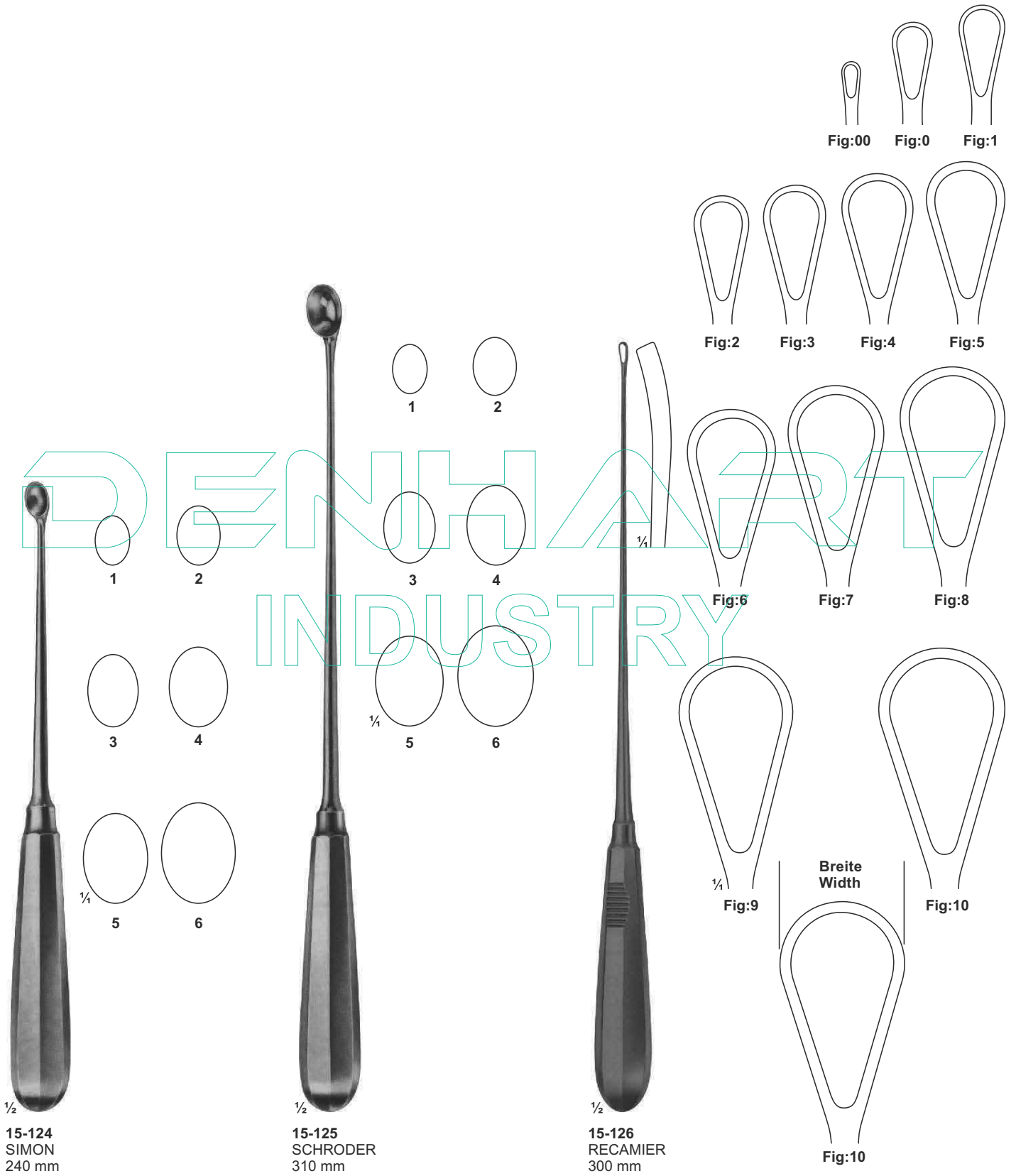

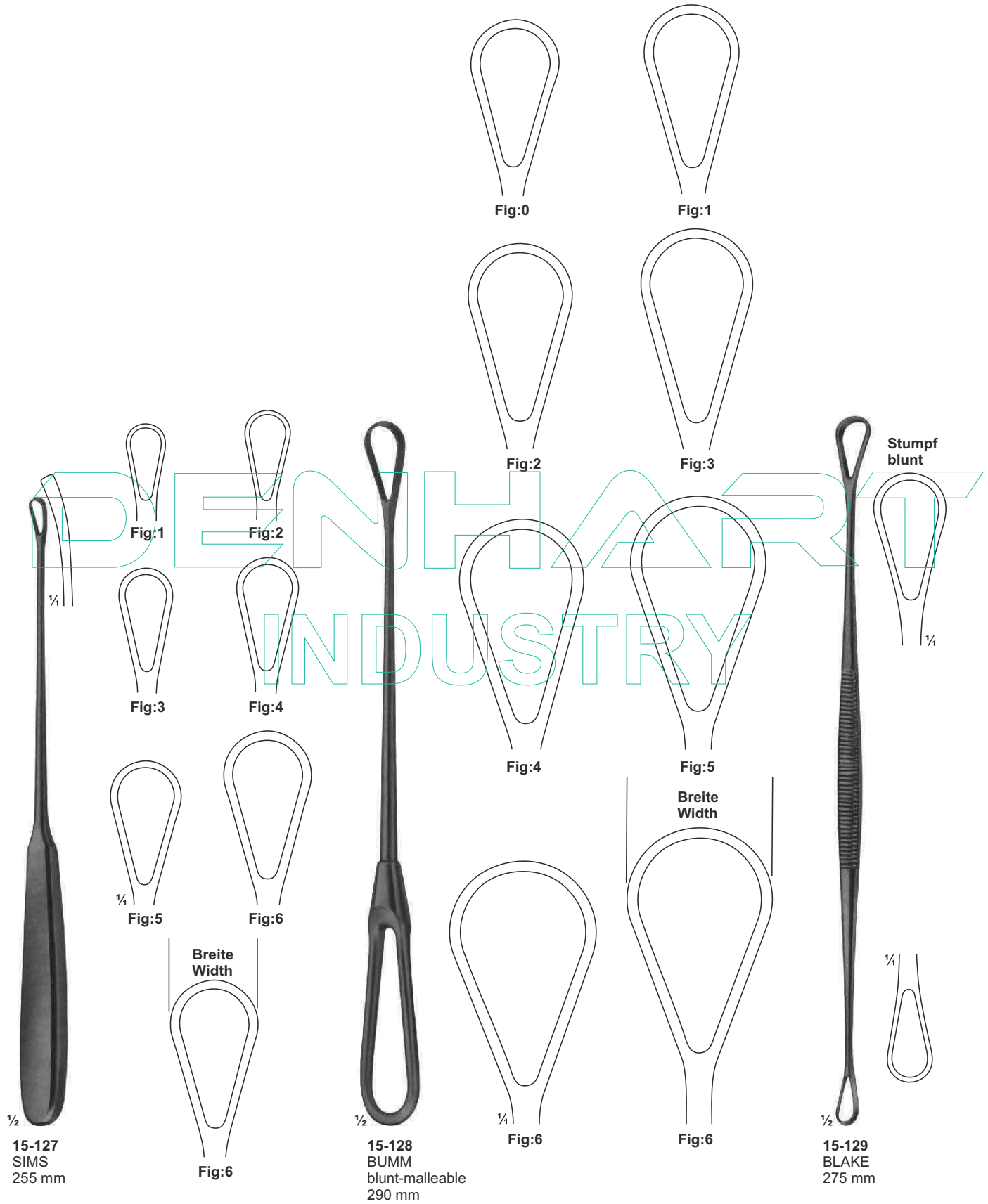

**15-127
SIMS
255 mm**

**15-128
BUMM
blunt-malleable
290 mm**

**15-129
BLAKE
275 mm**



15-130
COLLIN
300 mm



15-131
RECAMIER
blunt-rigid
360 mm



15-132
BUMM
310 mm

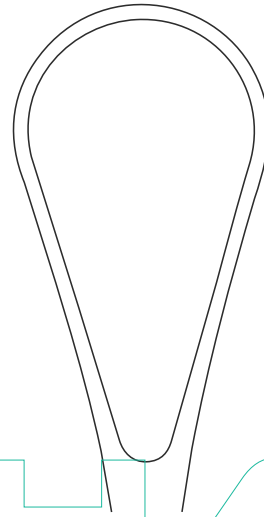

Fig:1

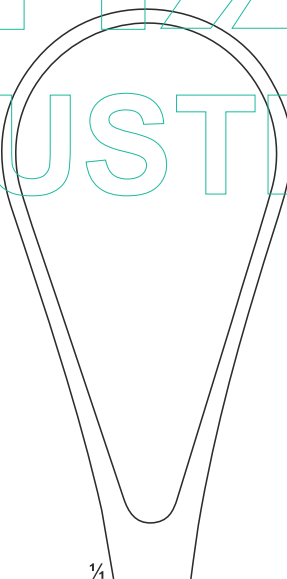

Fig:2

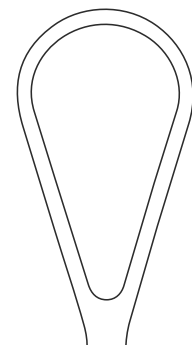

Fig:1

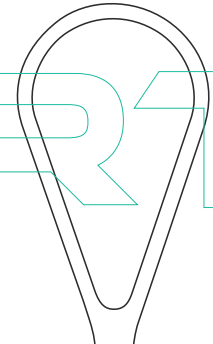

Fig:2

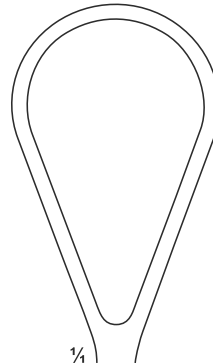
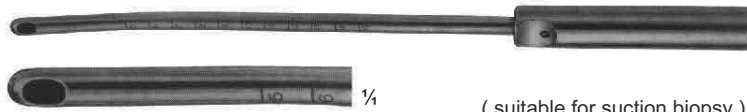

Fig:3

15-133 - 138

Suction curettes, stainless steel, fitting hose connection.

Working tips are smoothly rounded of, therefore no danger of perforation.



(suitable for suction biopsy)
15-133: diam 4 mm
15-134: diam 6 mm
15-135: diam 8 mm
15-136: diam 10 mm
15-137: diam 12 mm
15-138: diam 14 mm

15-139

Hose connection inside diam. 11 mm curved stainless steel.

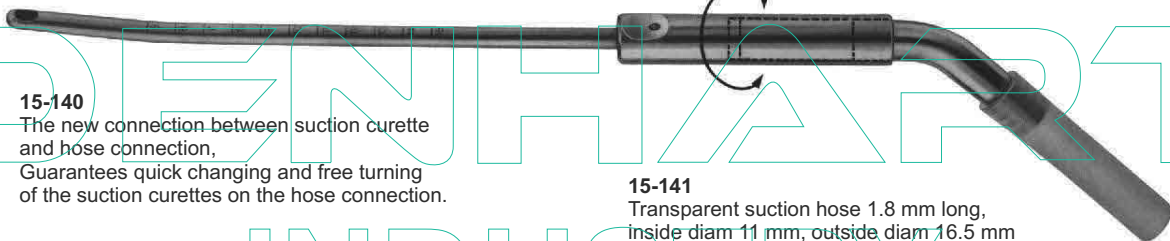

15-140

The new connection between suction curette and hose connection, Guarantees quick changing and free turning of the suction curettes on the hose connection.

15-141

Transparent suction hose 1.8 m long, inside diam 11 mm, outside diam 16.5 mm can be sterilized in an autoclave at 1 bar overpressure (120 C)



15-142

Strainer for tissues, plastic, for single use only, to be used for histopathological examination.



15-143 diam 8 mm
15-144 diam 10 mm
BOZEMANN-FRITSCH
Uterine Flushing Tube
350 mm



DENHART
INDUSTRY

15-145
SCHULZE
Salpingograph, for utero-salpingography
in wooden case, consisting of:
Manometer, Connection, Uterine canulla
with tap, Cone S.M.L.,
Record Syringe 10 cc, Luer lock mount.

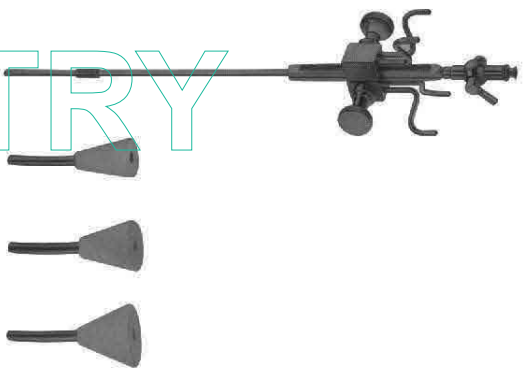

15-146
SCHULZE
Salpingograph, equipment
without manometer.

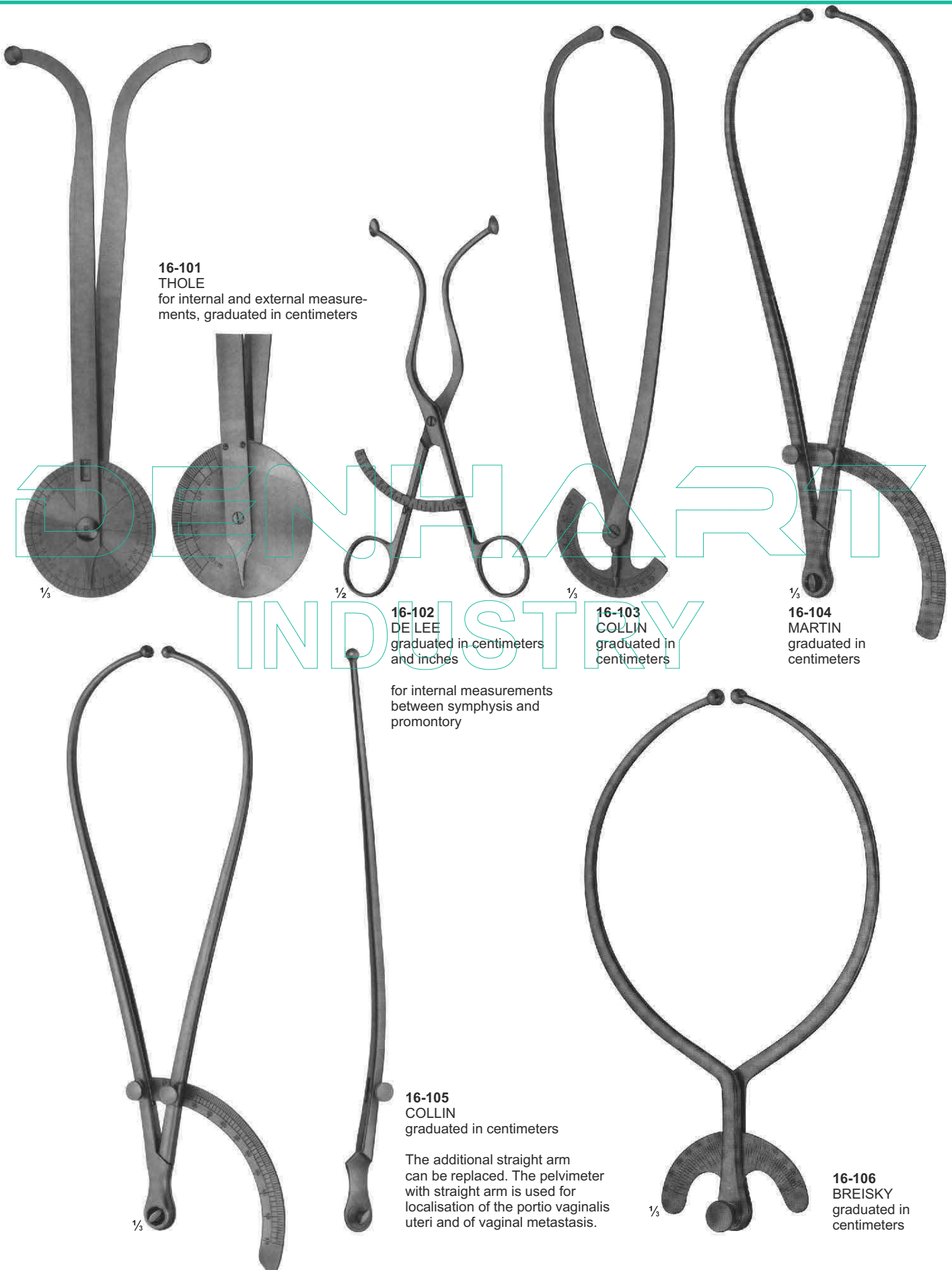

16-101
THOLE
for internal and external measurements, graduated in centimeters

1/3

1/2

1/3

1/3

16-102
DE LEE
graduated in centimeters and inches

16-103
COLLIN
graduated in centimeters

16-104
MARTIN
graduated in centimeters

for internal measurements between symphysis and promontory

16-105
COLLIN
graduated in centimeters

The additional straight arm can be replaced. The pelvimeter with straight arm is used for localisation of the portio vaginalis uteri and of vaginal metastasis.

16-106
BREISKY
graduated in centimeters

1/3

1/3



16-107
HERFF
puncturing forceps
225 mm



16-108
IOWA
puncturing forceps
260 mm

DENHART
INDUSTRY



16-109
SCHUMACHER
Umbilical cord
scissors
155 mm



16-110
Umbilical cord
scissors
105 mm

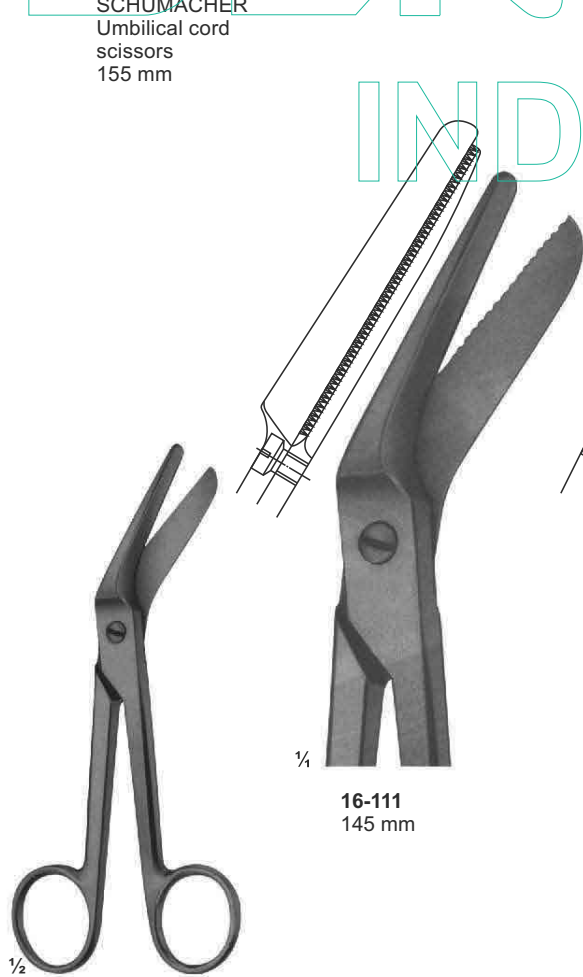

16-111
145 mm

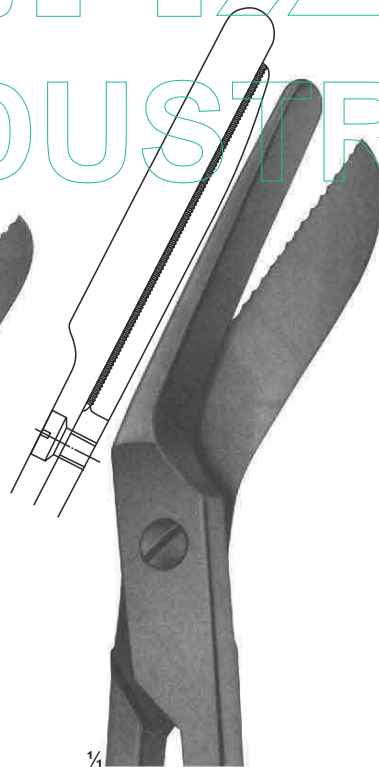

16-112
200 mm

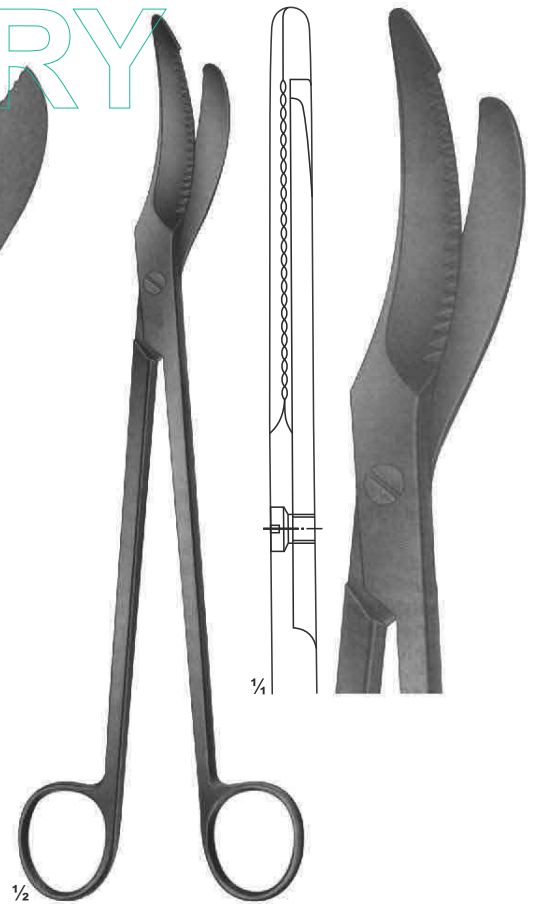

16-113
Episiotomy Scissors
240 mm

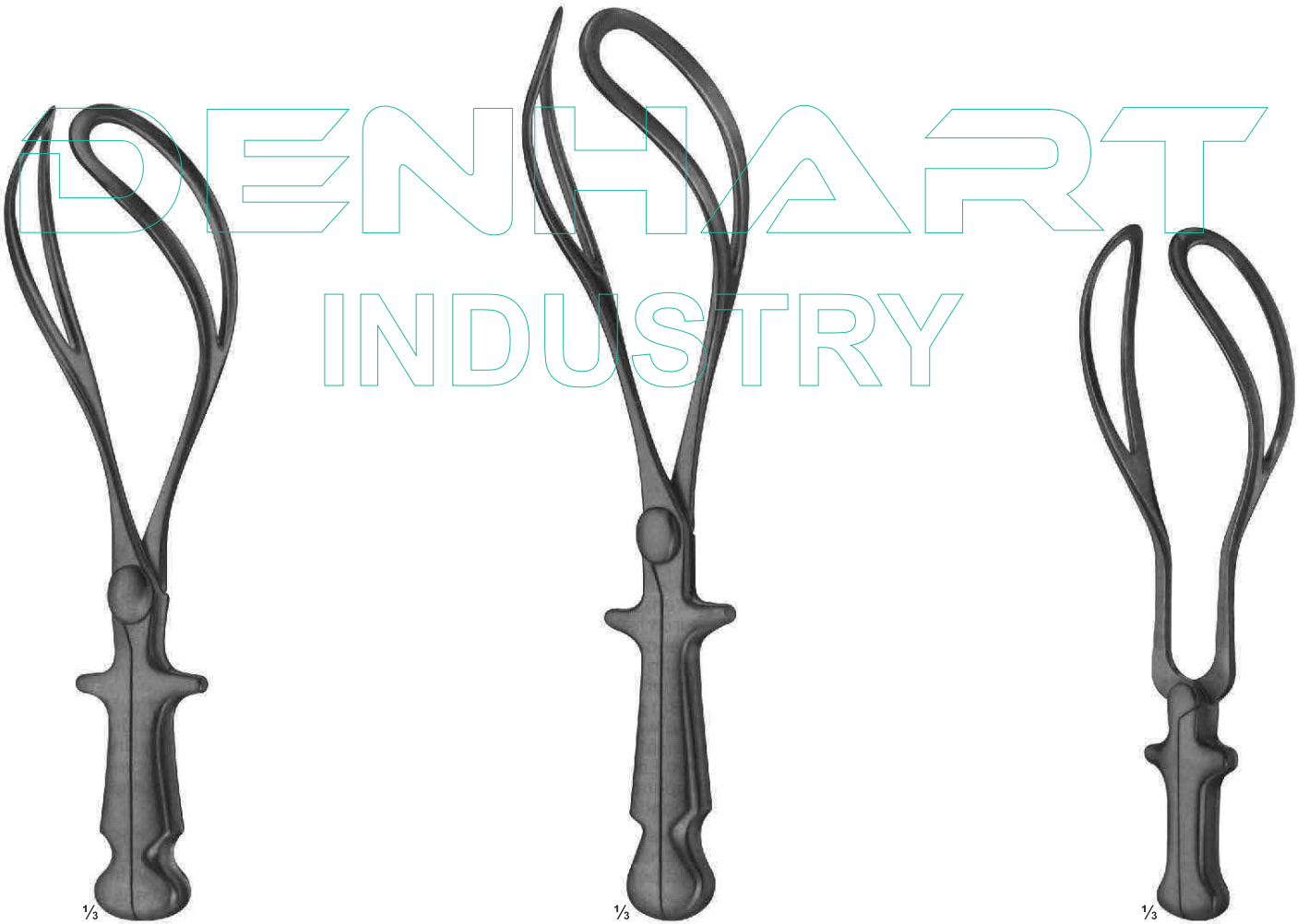

1/3

16-114
355 mm

1/3

16-115
400 mm

1/3

16-116
SIMPSON-BRAUN
305mm

DENHART INDUSTRY



1/3

16-117
SIMPSON-BRAUN
305mm



1/3

16-118
SIMPSON
235mm

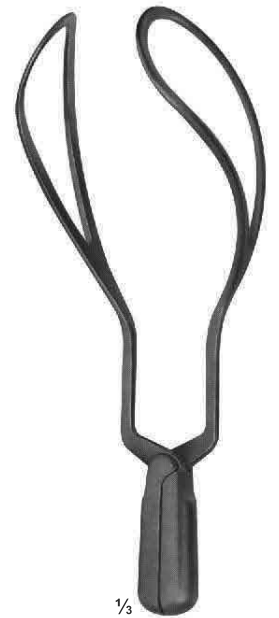

1/3

16-119
WRIGLEY
250 mm



16-120
GREEN-ARMYTAGE
Caesarean section haemostatic
forceps, for edges of the transverse
incision in the lower segment
220 mm

16-121
WILLETT
Scalpel Flap forceps
185 mm

16-122
GAUSS
Scalpel Flap forceps
260 mm



16-123 - 125
WINTER
290 mm

16-126 - 128
WINTER
290 mm

16-129
SAENGER
275 mm

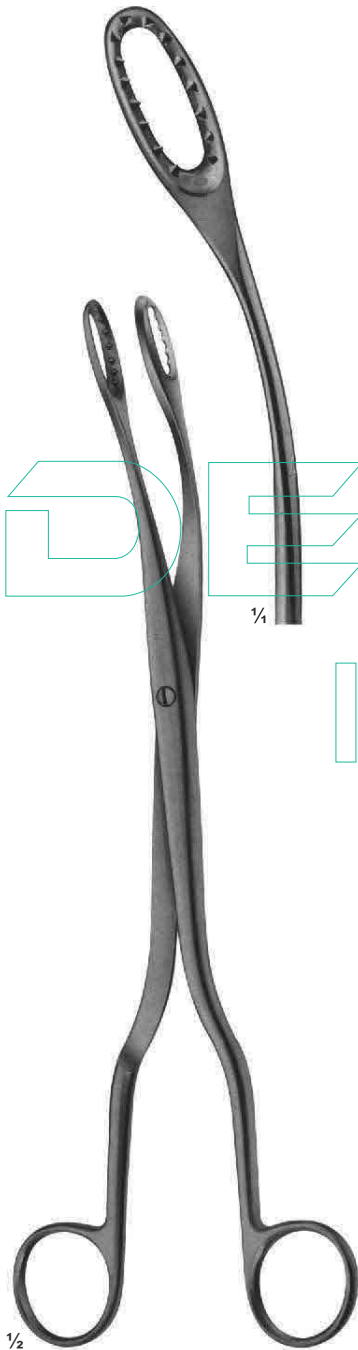

16-130
SAENGER
285 mm

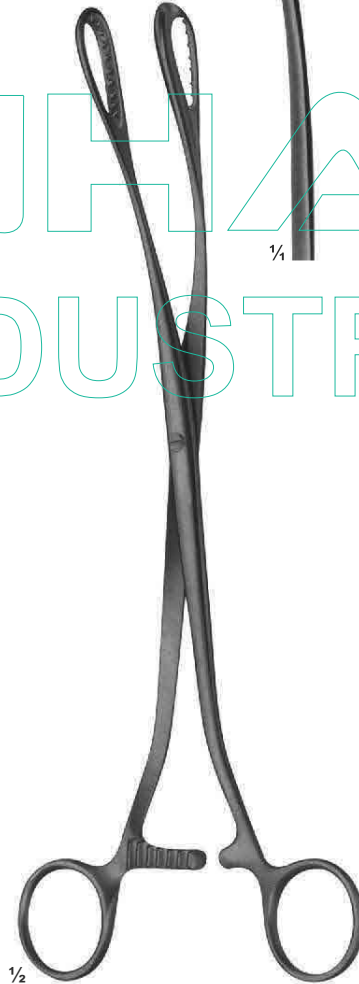

16-131
SAENGER
285 mm



16-132

16-133

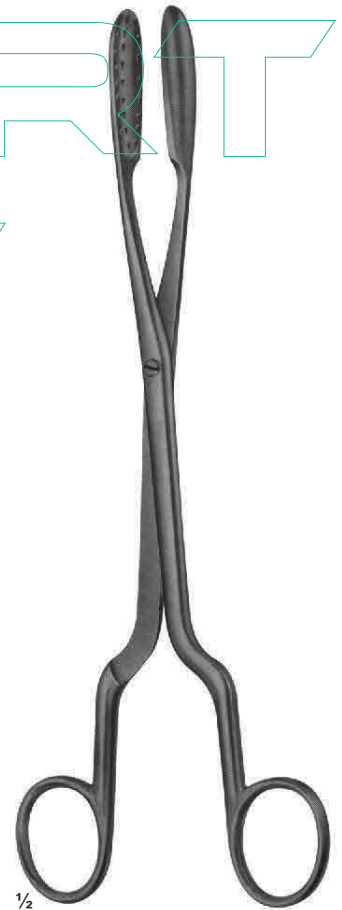

16-132 - 133
LEWKOWIZ
245 mm

DENHART
INDUSTRY



16-134
KELLY
320mm



16-135
SMELLIE
Perforator
270mm

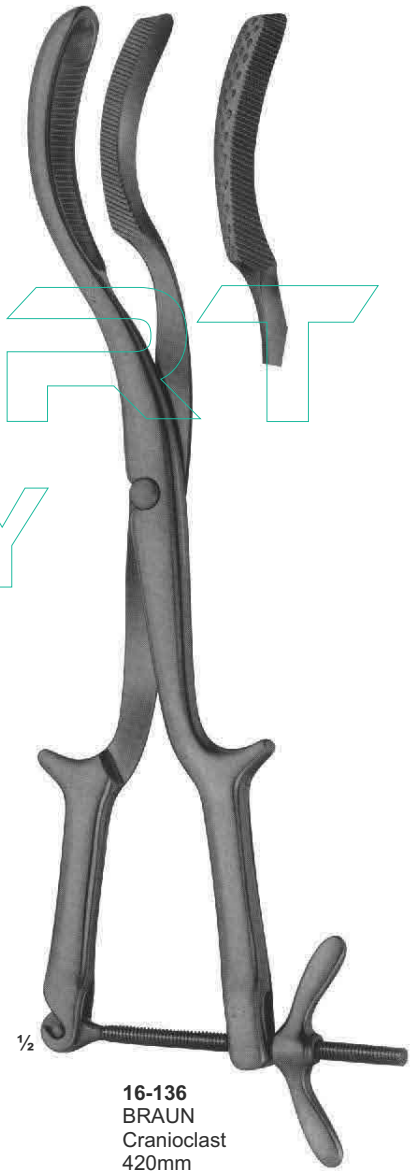

16-136
BRAUN
Cranioclast
420mm

DENHART
INDUSTRY



16-137
UECKERMANN-DENKER
Cryothyrotomy trocar
with silver cannula
130mm

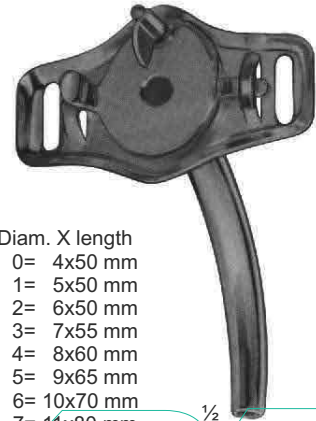

- Diam. X length
- 16-138** Fig. 0= 4x50 mm
 - 16-139** Fig. 1= 5x50 mm
 - 16-140** Fig. 2= 6x50 mm
 - 16-141** Fig. 3= 7x55 mm
 - 16-142** Fig. 4= 8x60 mm
 - 16-143** Fig. 5= 9x65 mm
 - 16-144** Fig. 6= 10x70 mm
 - 16-145** Fig. 7= 11x80 mm
 - 16-146** Fig. 8= 12x85 mm
 - 16-147** Fig. 9= 13x90 mm
 - 16-148** Fig. 10= 14x90 mm

16-138 - 148
LUER
German silver

INDUSTRY



16-149 - 158
JACKSON
German Silver

- Diam. X length
- 16-149** Fig. 0= 4x50 mm
 - 16-150** Fig. 1= 5x58 mm
 - 16-151** Fig. 2= 6x58 mm
 - 16-152** Fig. 3= 7x70 mm
 - 16-153** Fig. 4= 8x78 mm
 - 16-154** Fig. 5= 9x84 mm
 - 16-155** Fig. 6= 10x84 mm
 - 16-156** Fig. 7= 11x86 mm
 - 16-157** Fig. 8= 12x88 mm
 - 16-158** Fig. 9= 13x90 mm



- Diam. X length
- 16-159** Fig. 1= 5x48 mm
 - 16-160** Fig. 2= 6x58 mm
 - 16-161** Fig. 3= 7x70 mm
 - 16-162** Fig. 4= 8x78 mm
 - 16-163** Fig. 5= 9x84 mm
 - 16-164** Fig. 6= 10x84 mm
 - 16-165** Fig. 7= 11x86 mm
 - 16-166** Fig. 8= 12x88 mm
 - 16-167** Fig. 9= 13x90 mm
 - 16-168** Fig. 10= 14x90 mm

16-159 - 168
JACKSON
German Silver



16-169
BOSE
165 mm



16-170
BOSE
165 mm



16-171 - 173
180 mm



16-171
sharp



16-172
blunt



16-173
stumpf/blunt

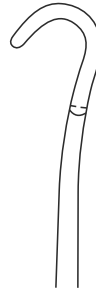

16-174
FINSÉN
50 mm

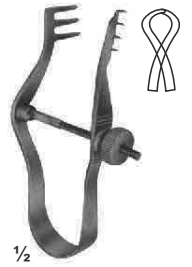

16-175
FINSÉN
70 mm

DENHART
INDUSTRY



16-176
TROUSSEAU
120 mm



16-177
LABORDE
125 mm

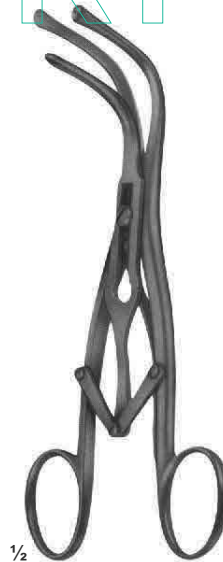

16-178
LABORDE
strong pattern
135 mm



16-179
Cleaning Brush
for tracheal tubes
285 mm

DENHART INDUSTRY



17-101 - 104
SCHMID
Vessel irrigating cannulae,
malleable, silver plated
150 mm

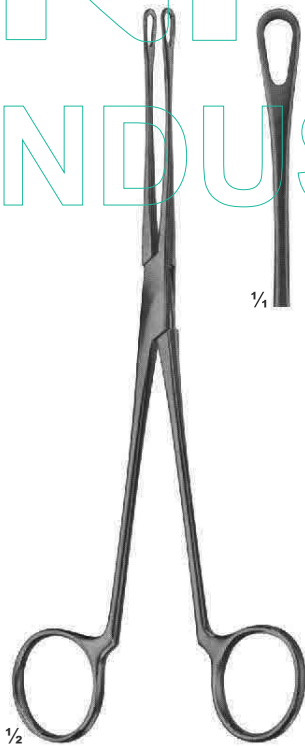

17-105
BLAKE
Embolus grasping
forceps
205 mm

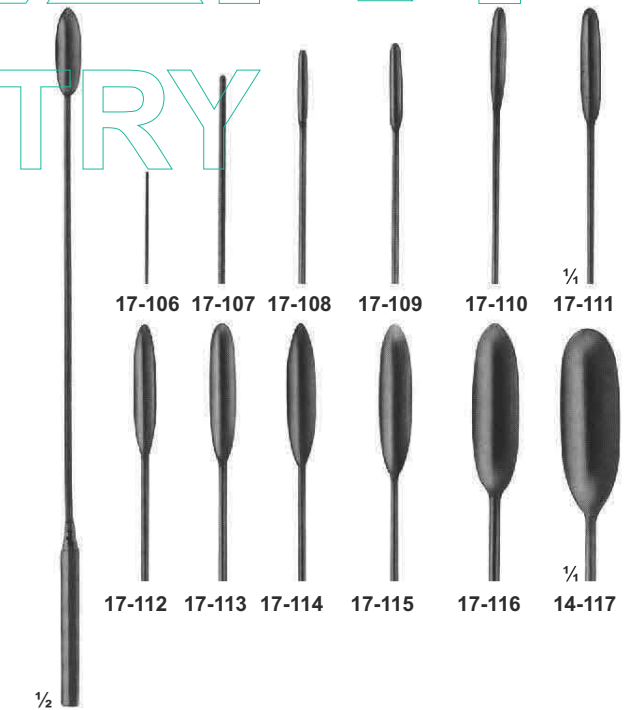

17-106 - 117 DE BAKEY Vascular dilators, malleable 190 mm	17-106 0,5 mm Ø	17-112 3,5 mm Ø
	17-107 1,0 mm Ø	17-113 4,0 mm Ø
	17-108 1,5 mm Ø	17-114 4,5 mm Ø
	17-109 2,0 mm Ø	17-115 5,0 mm Ø
	17-110 2,5 mm Ø	17-116 7,0 mm Ø
	17-111 3,0 mm Ø	17-117 9,0 mm Ø

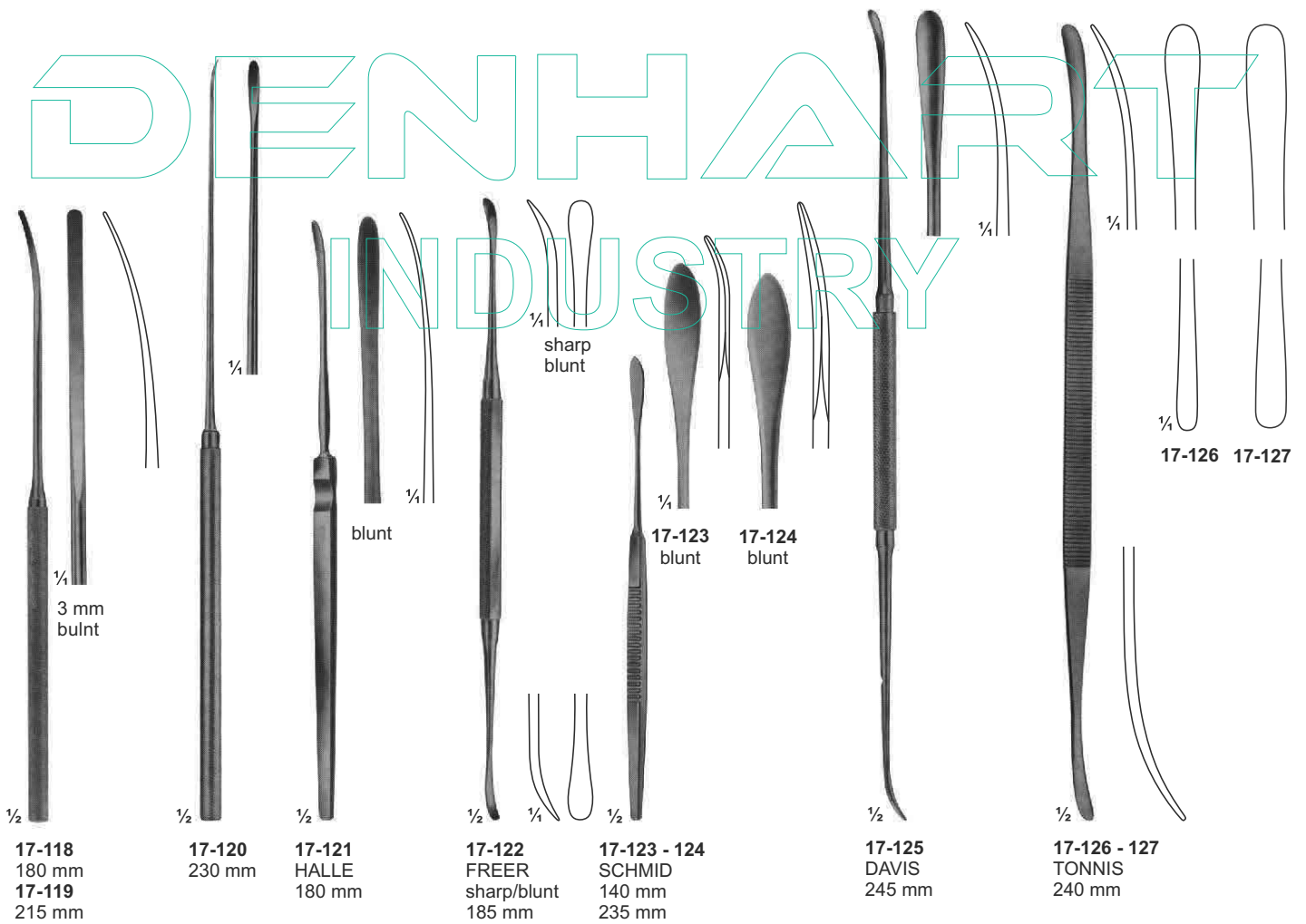

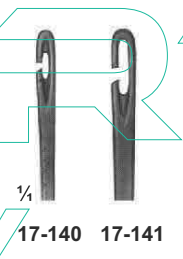
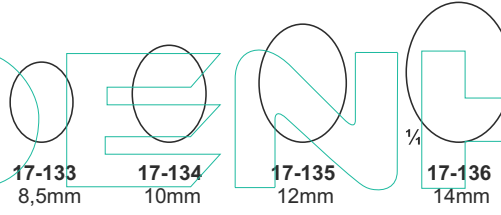
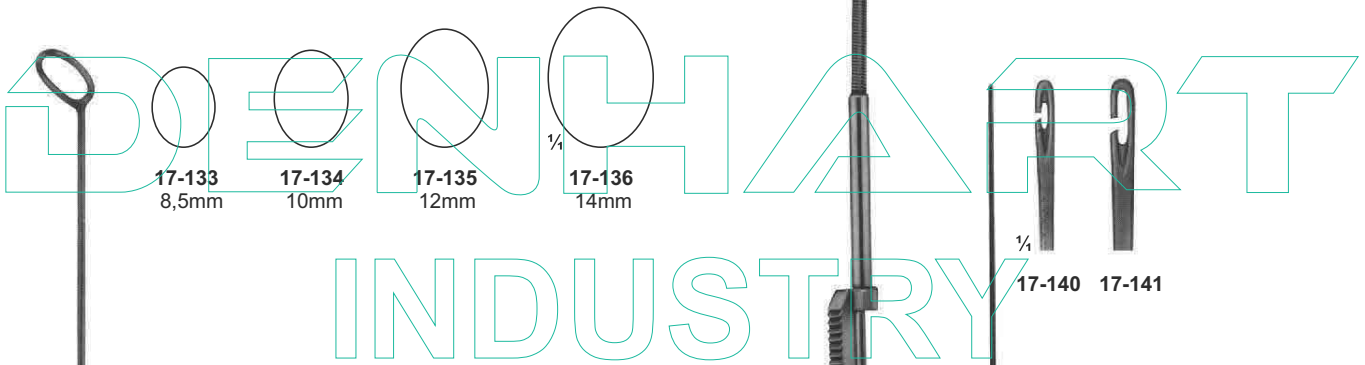
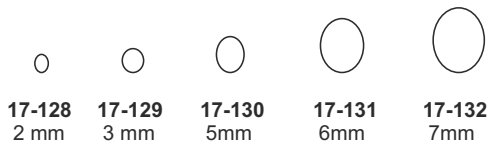

17-128 - 136
Endarterectomy strippers
550 mm



17-137
Handle for
110 mm

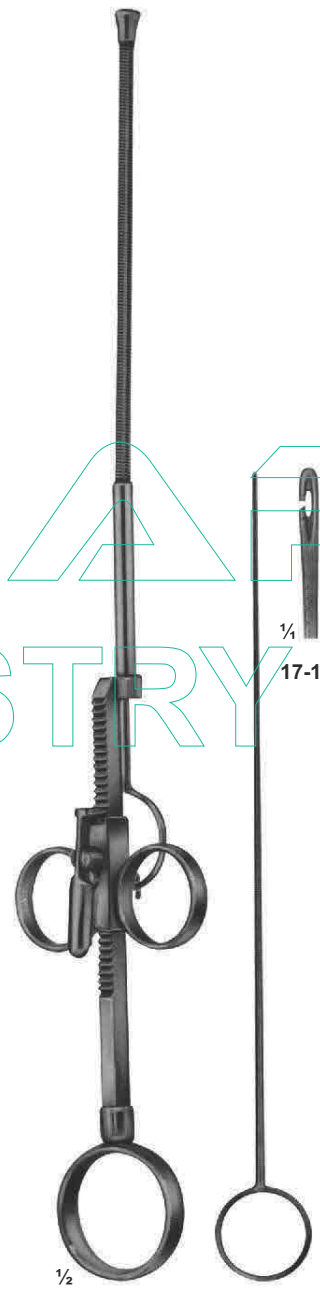

17-138 - 139
RUMEL-BELBONT
325 mm
17-138 - 4,0 mm Ø
17-139 - 6,4 mm Ø



17-140 - 141
Guide only

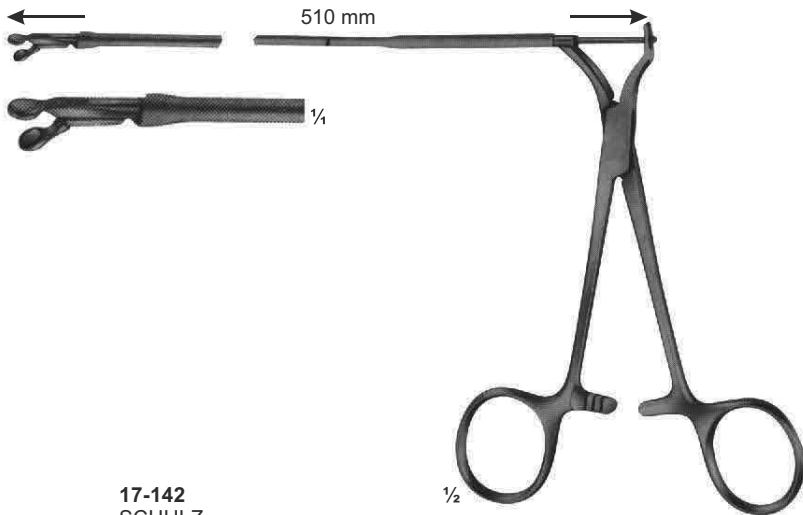

**17-142
SCHULZ**
Biopotome, mit flexiblem Schaft, 510 mm lang,
with round jaws 3 mm diam.

Biopsy forceps, for biopsy from the right atrium
through cava juglaris, prior to heart implantations.

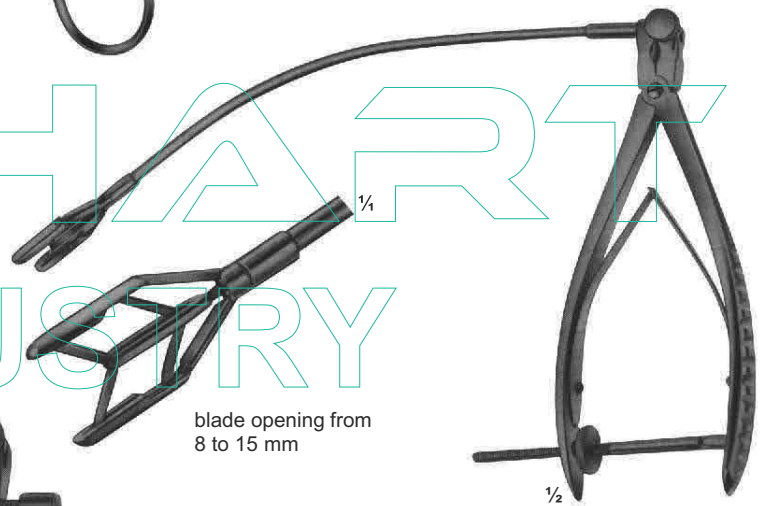

**17-144
COOLEY**
Dilator for
mitral valve
for children

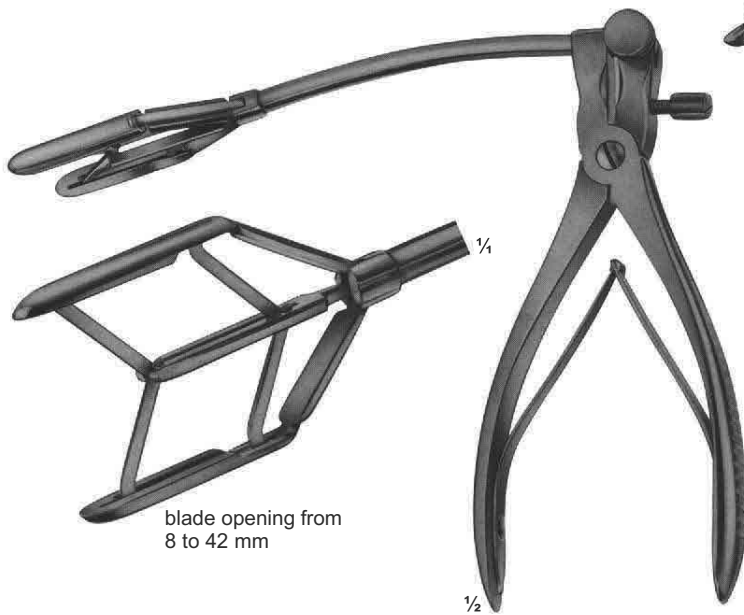

blade opening from
8 to 42 mm

**17-143
TUBBS**
Dilator for
mitral valve

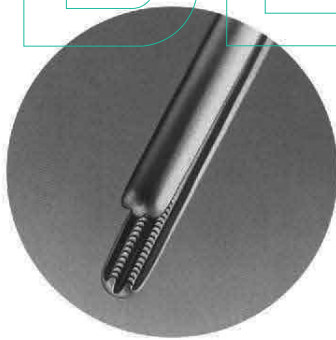
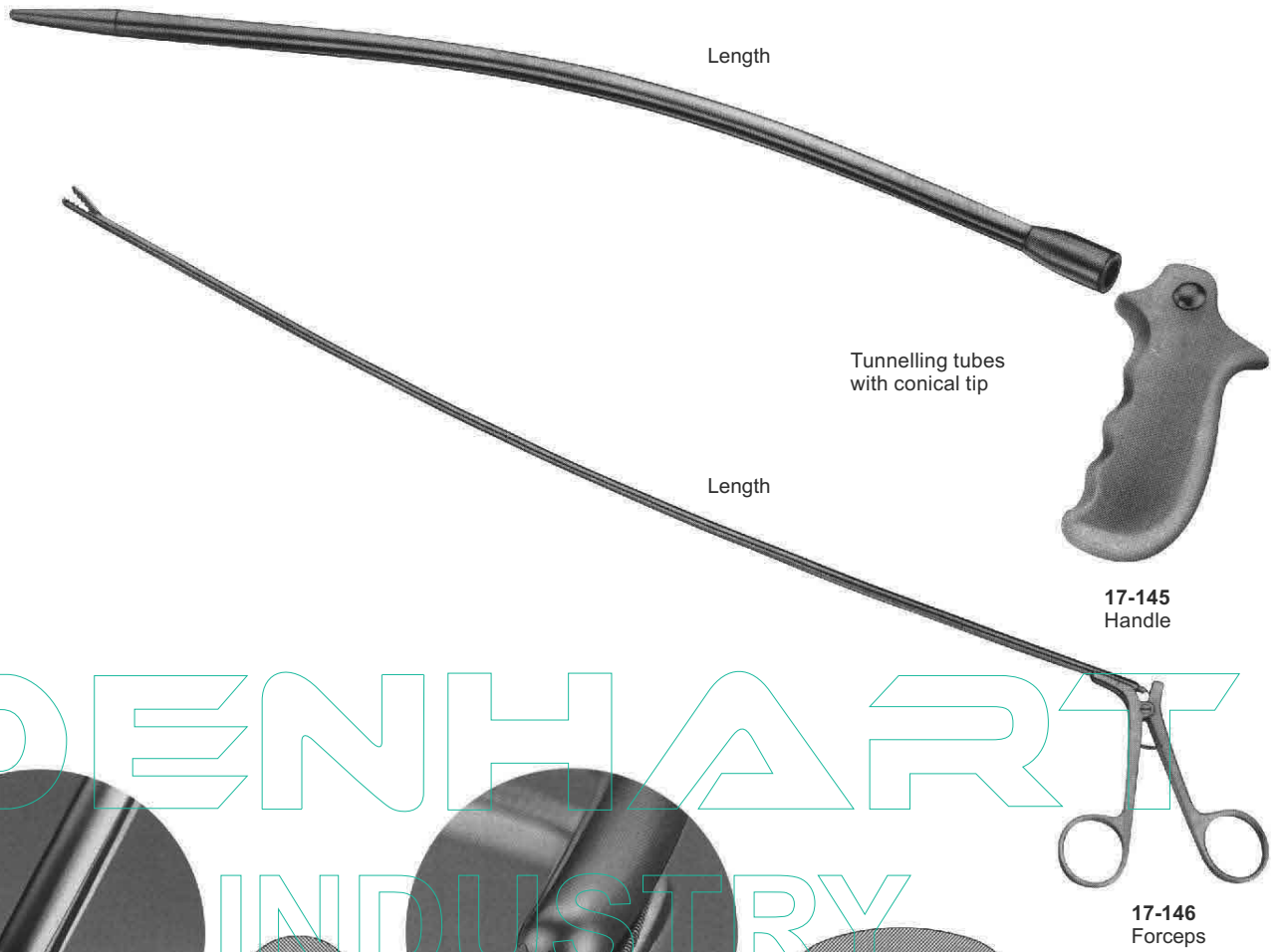

DE BAKEY
17-147
1 : 2 rows of teeth

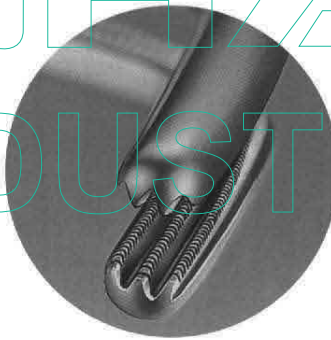
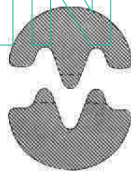

DE BAKEY
17-148
2 : 3 rows of teeth

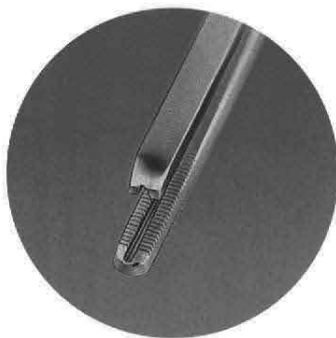
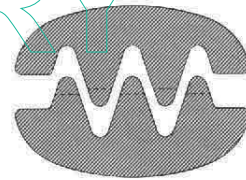

COOLEY
17-149
2 : 2 rows of teeth

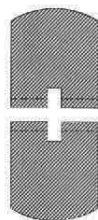

DARDIK
17-150
2 : 3 rows of teeth

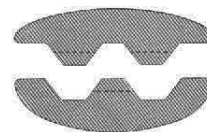

DENHART
INDUSTRY



17-151
Width of jaws
1,5 mm
Length
150mm

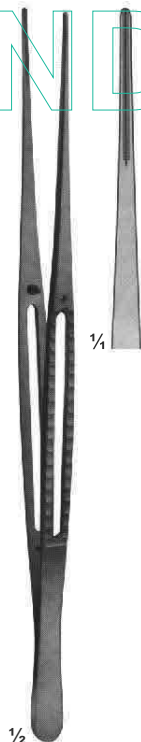

17-152
1,5 mm
200 mm



17-153
1,5 mm
240 mm



17-154
1,5 mm
300 mm

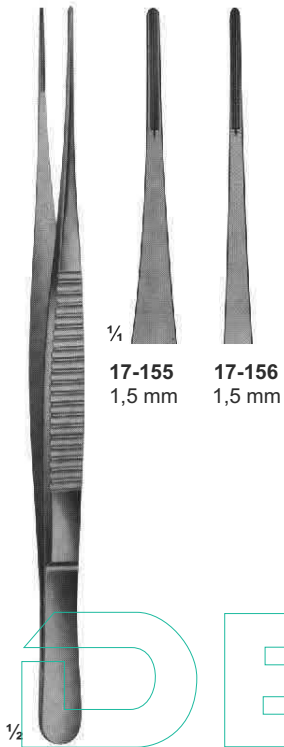

17-155
1,5 mm

17-156
1,5 mm

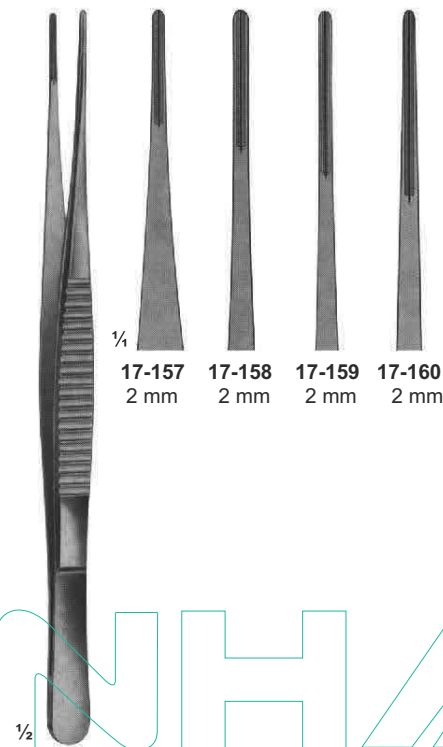

17-157
2 mm

17-158
2 mm

17-159
2 mm

17-160
2 mm

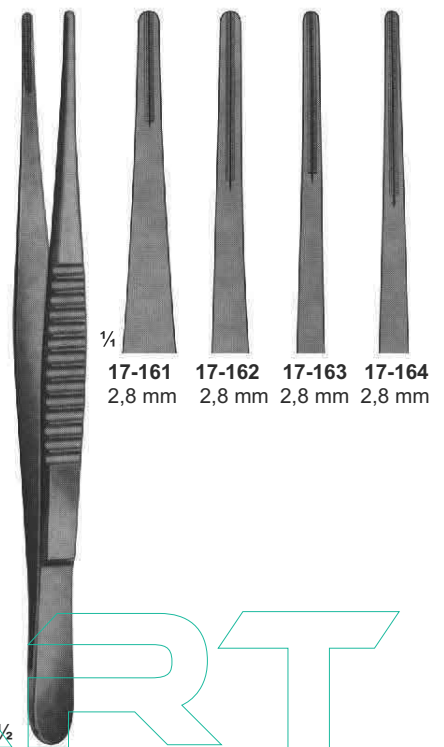

17-161
2,8 mm

17-162
2,8 mm

17-163
2,8 mm

17-164
2,8 mm

17-155 - 156
DE BAKEY
150 mm
300 mm

17-157 - 160
DE BAKEY
150 mm 200 mm
300 mm 240 mm

17-161 - 164
DE BAKEY
150 mm 200 mm
300 mm 240 mm

DENHART
INDUSTRY

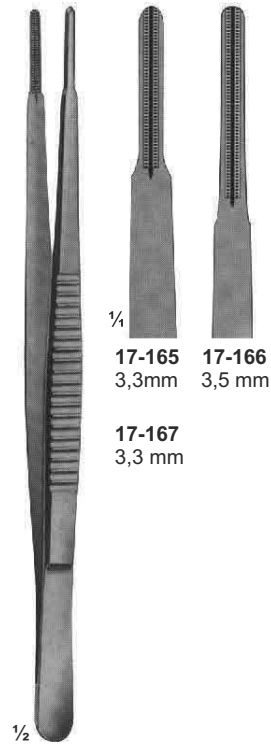

17-165
3,3mm

17-166
3,5 mm

17-167
3,3 mm

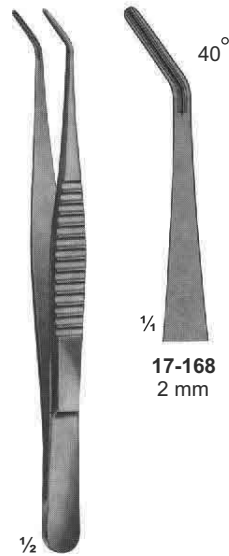

17-168
2 mm

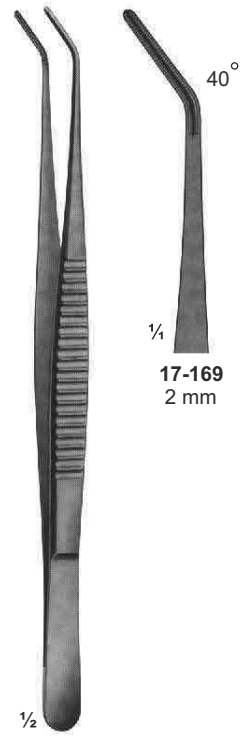

17-169
2 mm

17-165 - 167
DE BAKEY
200 mm
300 mm 240 mm

17-168
DE BAKEY
150 mm

17-169
DE BAKEY
200 mm

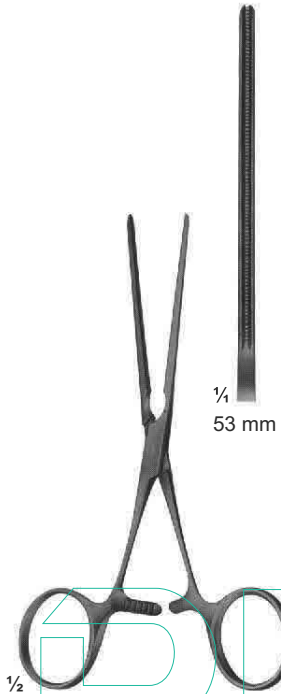

17-170
DE-BAKEY
gerade straight
130 mm

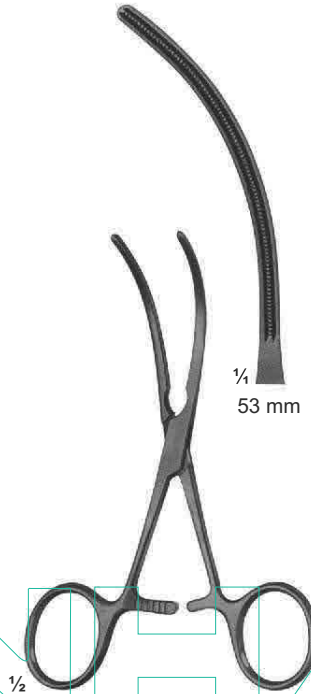

17-171
DE-BAKEY
Maul gebogen
curved jaws
125 mm

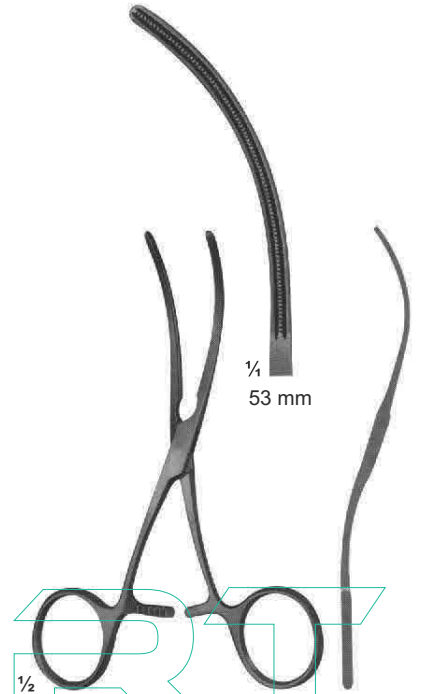

17-172
DE-BAKEY
S-shaped curved
125 mm

INDUSTRY

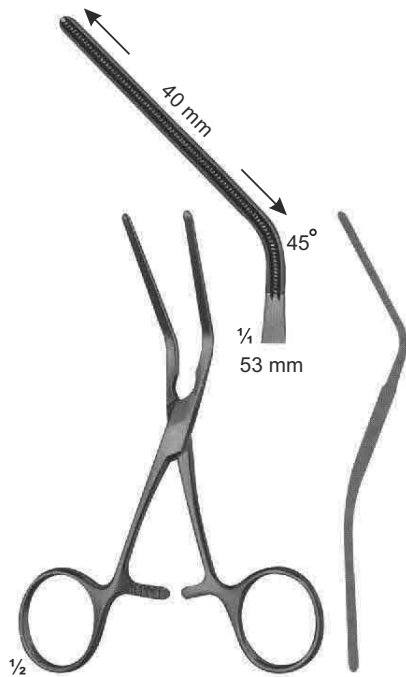

17-173
DE-BAKEY
45° winklig gebogen
angled 45°
125 mm

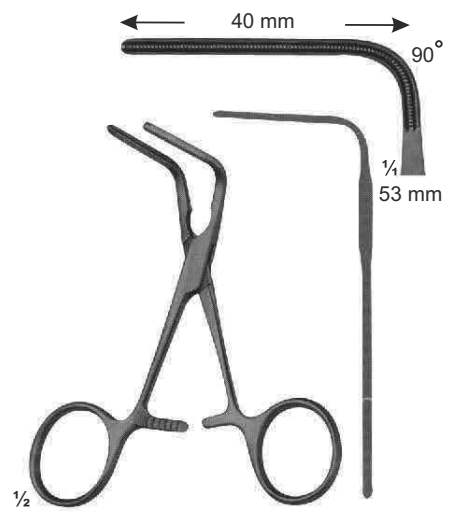

17-174
DE-BAKEY
90° winklig gebogen
angled 90°
105 mm

Anastomosis-and Multi-Purpose-Clamps for Neonatales

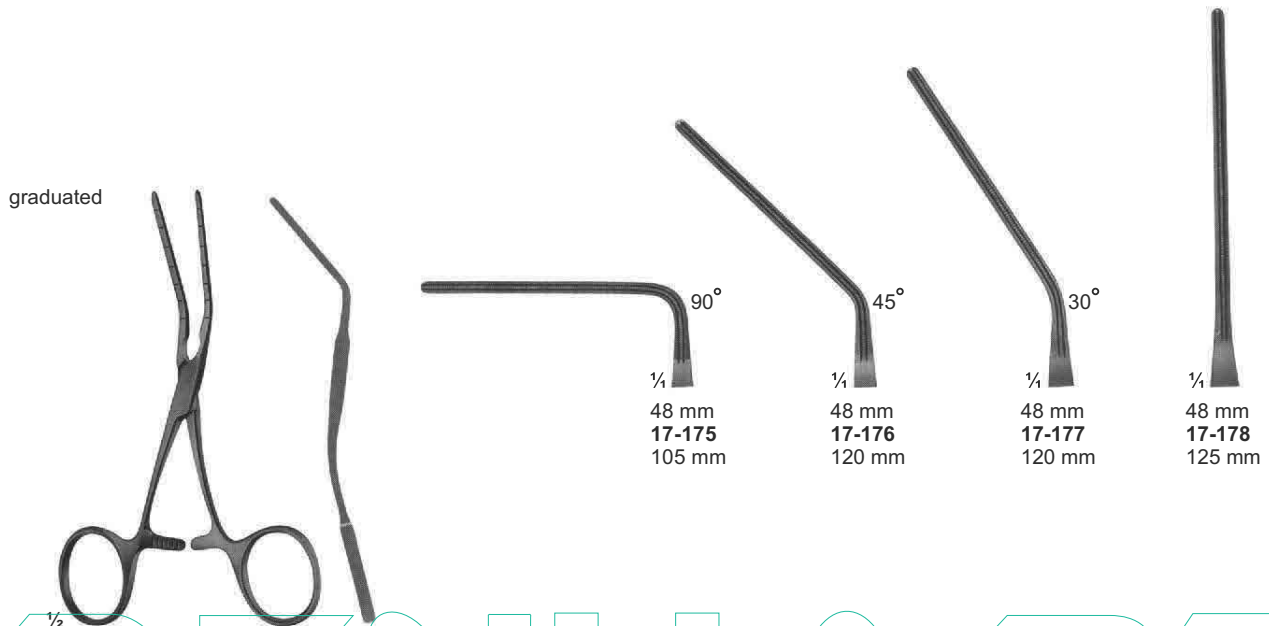

17-175 - 178
CASTANESA

90°
¼
48 mm
17-175
105 mm

45°
¼
48 mm
17-176
120 mm

30°
¼
48 mm
17-177
120 mm

¼
48 mm
17-178
125 mm

DENHART
INDUSTRY

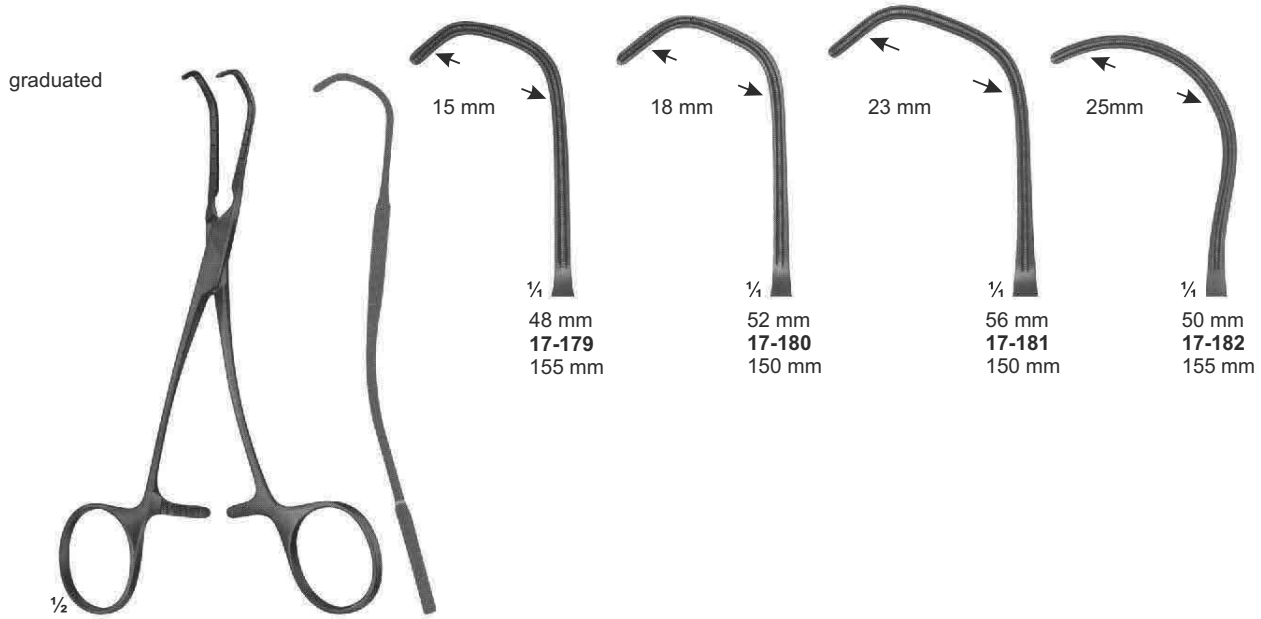

17-179 - 182
CASTANESA

15 mm
¼
48 mm
17-179
155 mm

18 mm
¼
52 mm
17-180
150 mm

23 mm
¼
56 mm
17-181
150 mm

25mm
¼
50 mm
17-182
155 mm

Anastomosis-and Multi-Purpose-Clamps-Pediatric types

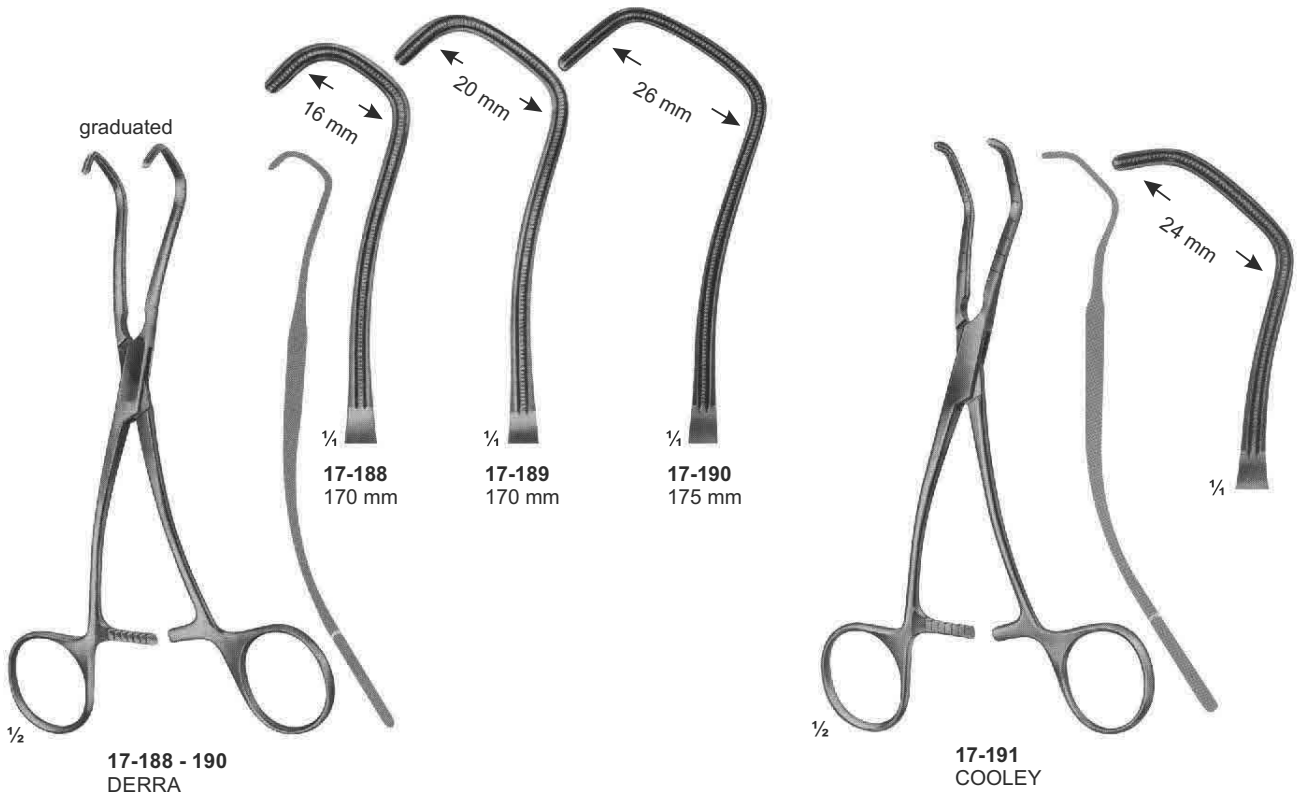
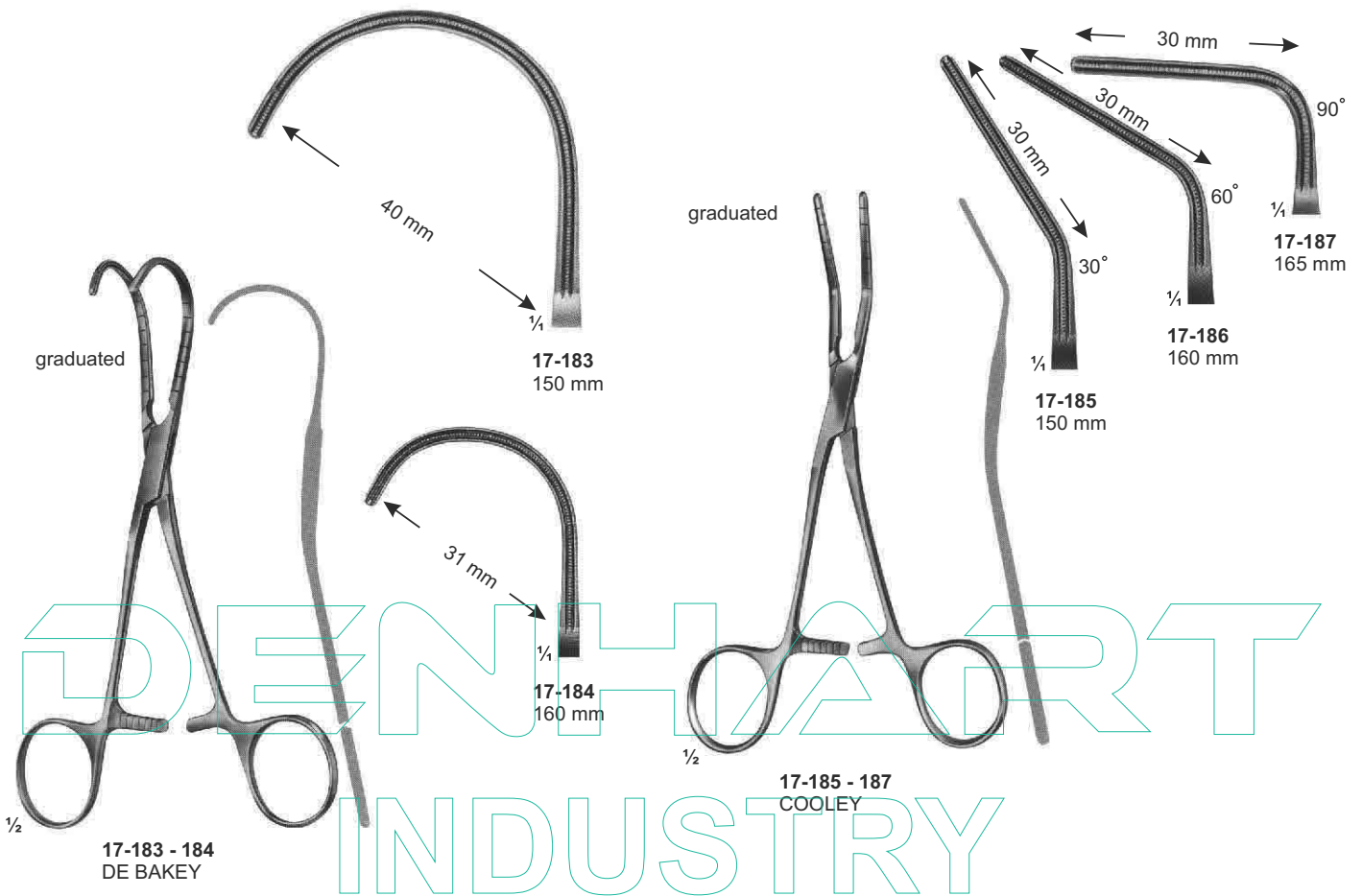



17-192 - 193
125 mm

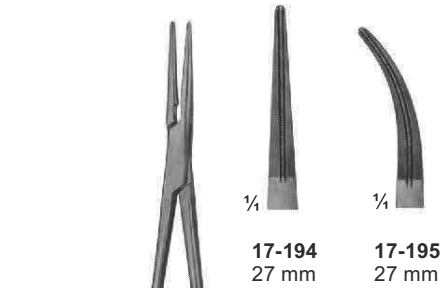

17-194 - 195
165 mm

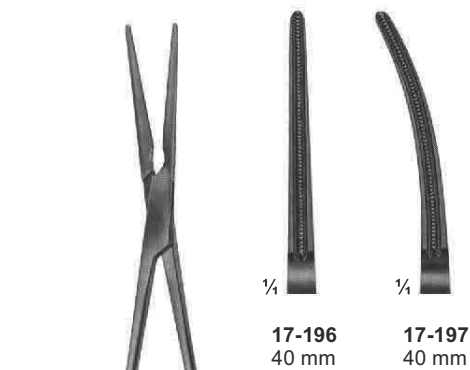

17-196 - 197
DE BAKEY-BAINRIDGE
155 mm

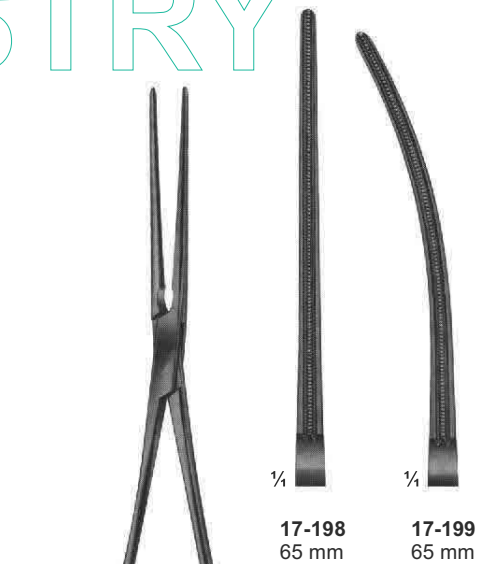

17-198 - 199
DE BAKEY-BAINRIDGE
180 mm

DENHART
INDUSTRY

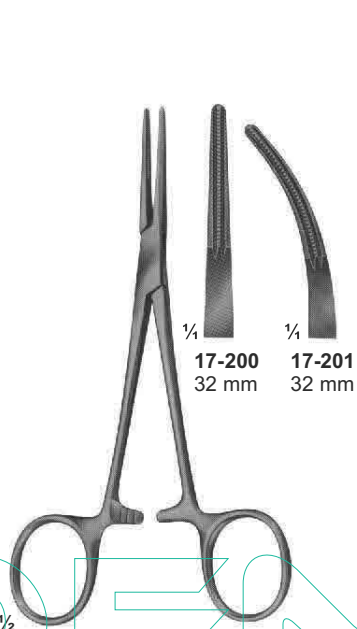

17-200
32 mm

17-201
32 mm

17-200 - 201
DE-BAKEY-KELLY
140 mm



17-202
50 mm

17-203
50 mm

17-202 - 203
PEAN
155 mm

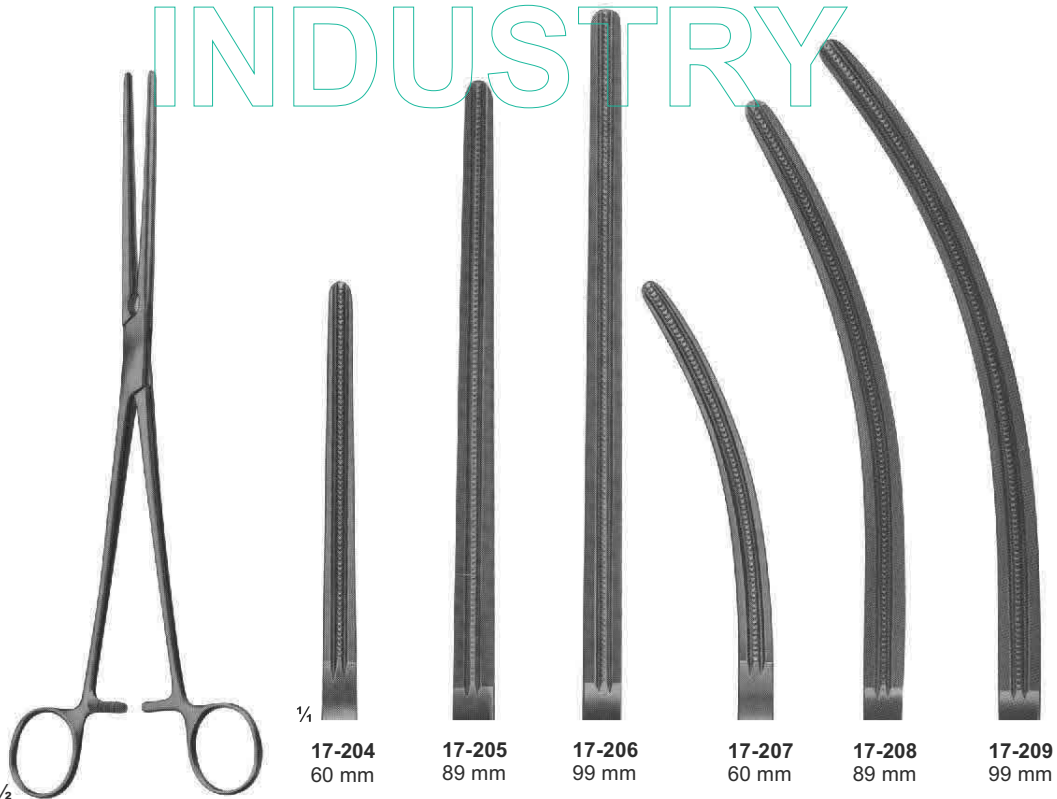

17-204 - 209
DE-BAKEY-PEAN

17-204 200 mm	17-207 200 mm
17-205 265 mm	17-208 260 mm
17-206 280 mm	17-209 275 mm

17-204 60 mm

17-205 89 mm

17-206 99 mm

17-207 60 mm

17-208 89 mm

17-209 99 mm

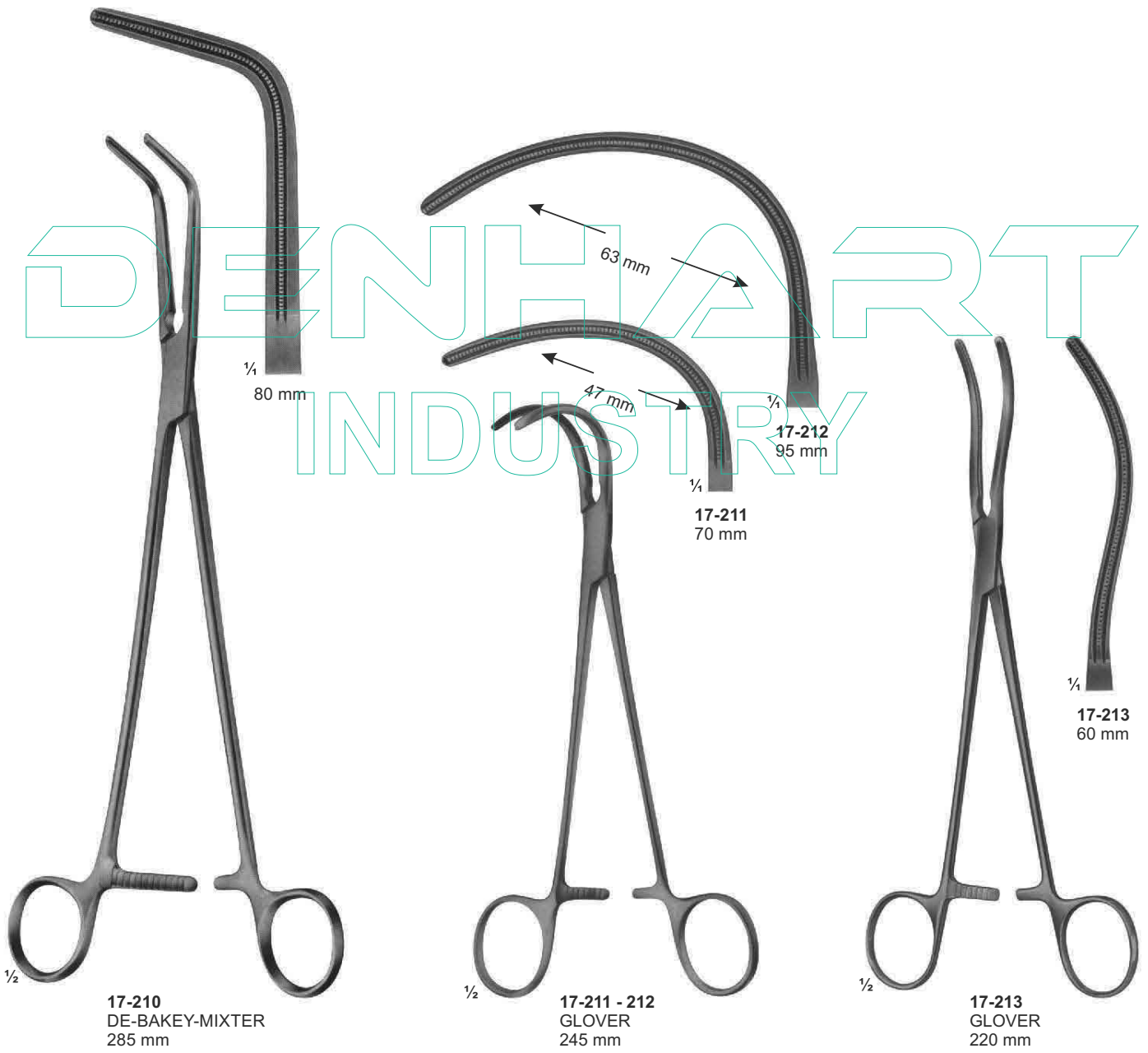

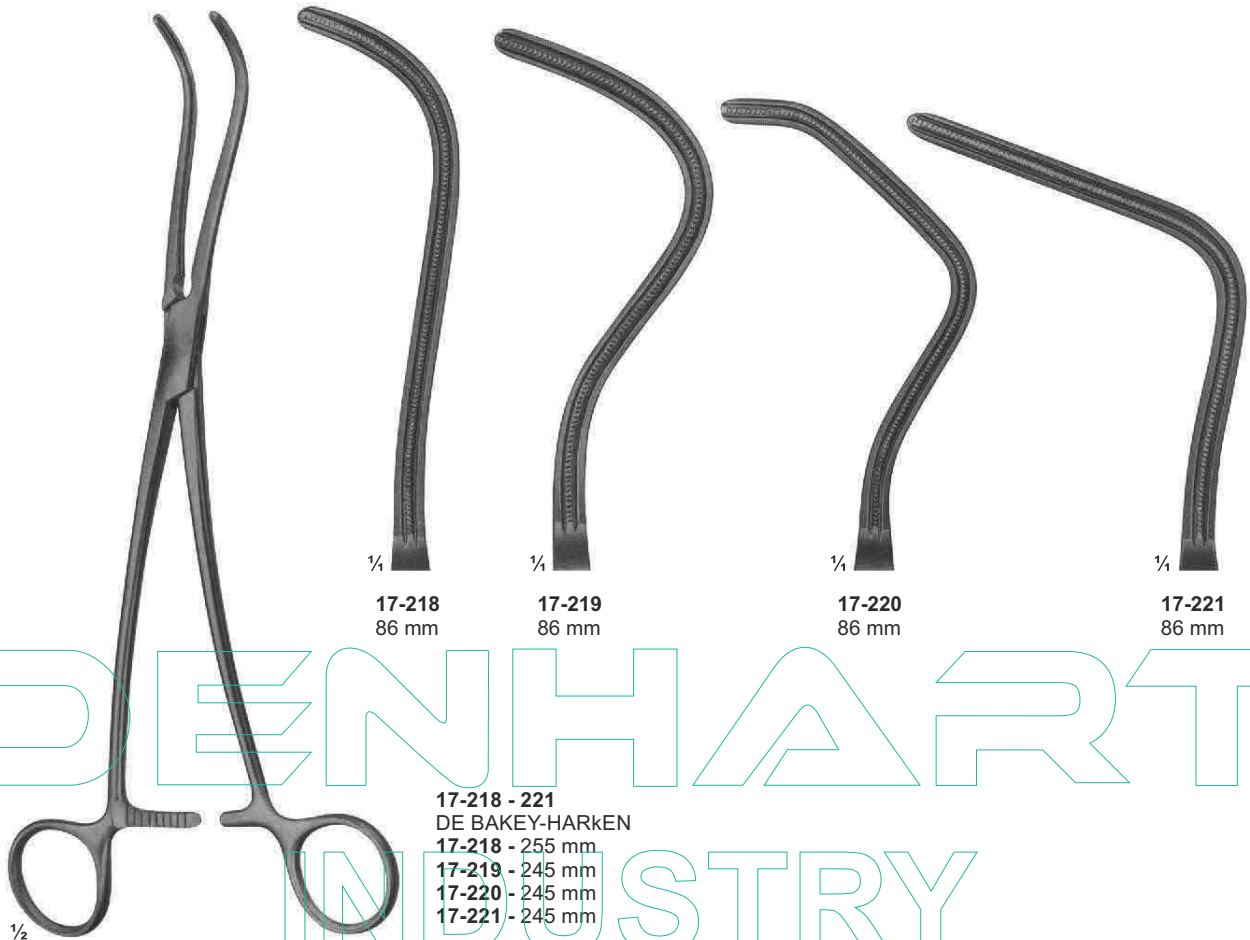

17-218 - 221
DE BAKEY-HARKEN
17-218 - 255 mm
17-219 - 245 mm
17-220 - 245 mm
17-221 - 245 mm

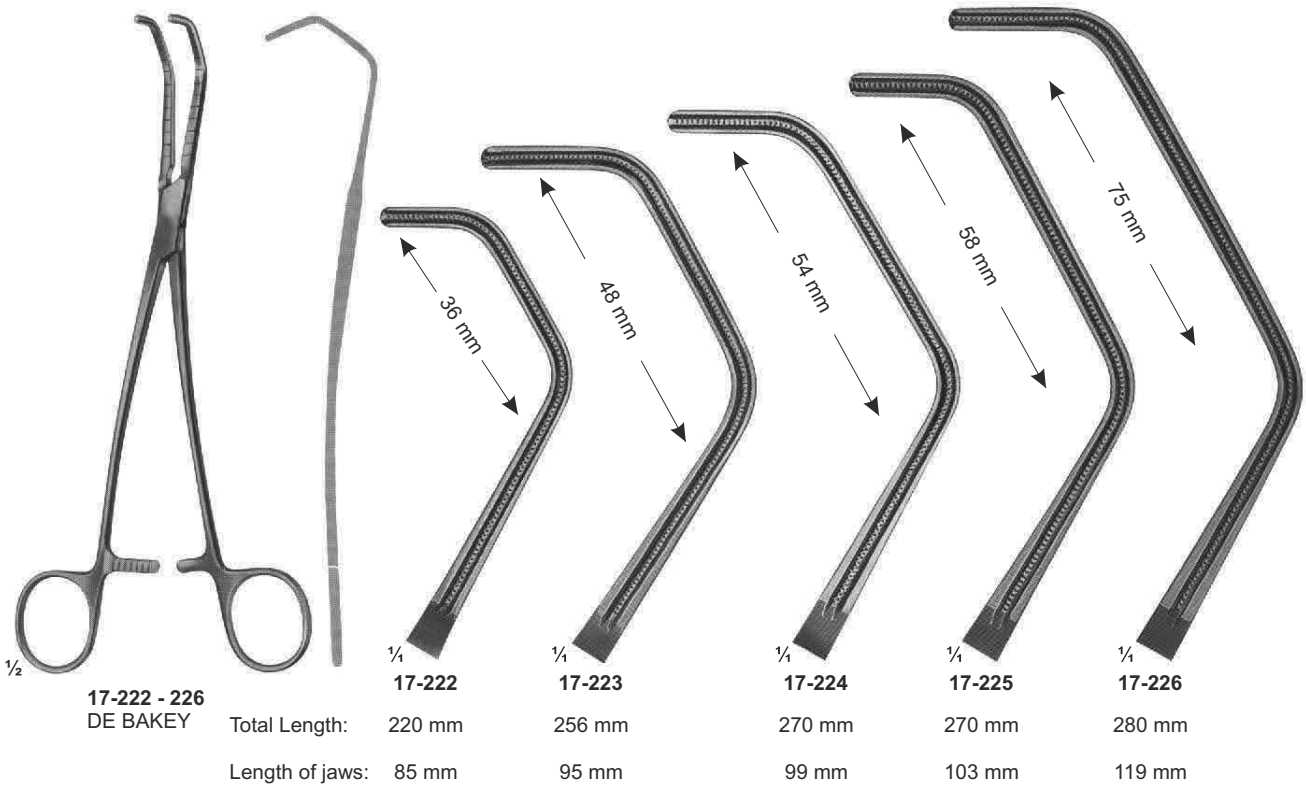

17-222 - 226
DE BAKEY

Total Length:	220 mm	256 mm	270 mm	270 mm	280 mm
Length of jaws:	85 mm	95 mm	99 mm	103 mm	119 mm

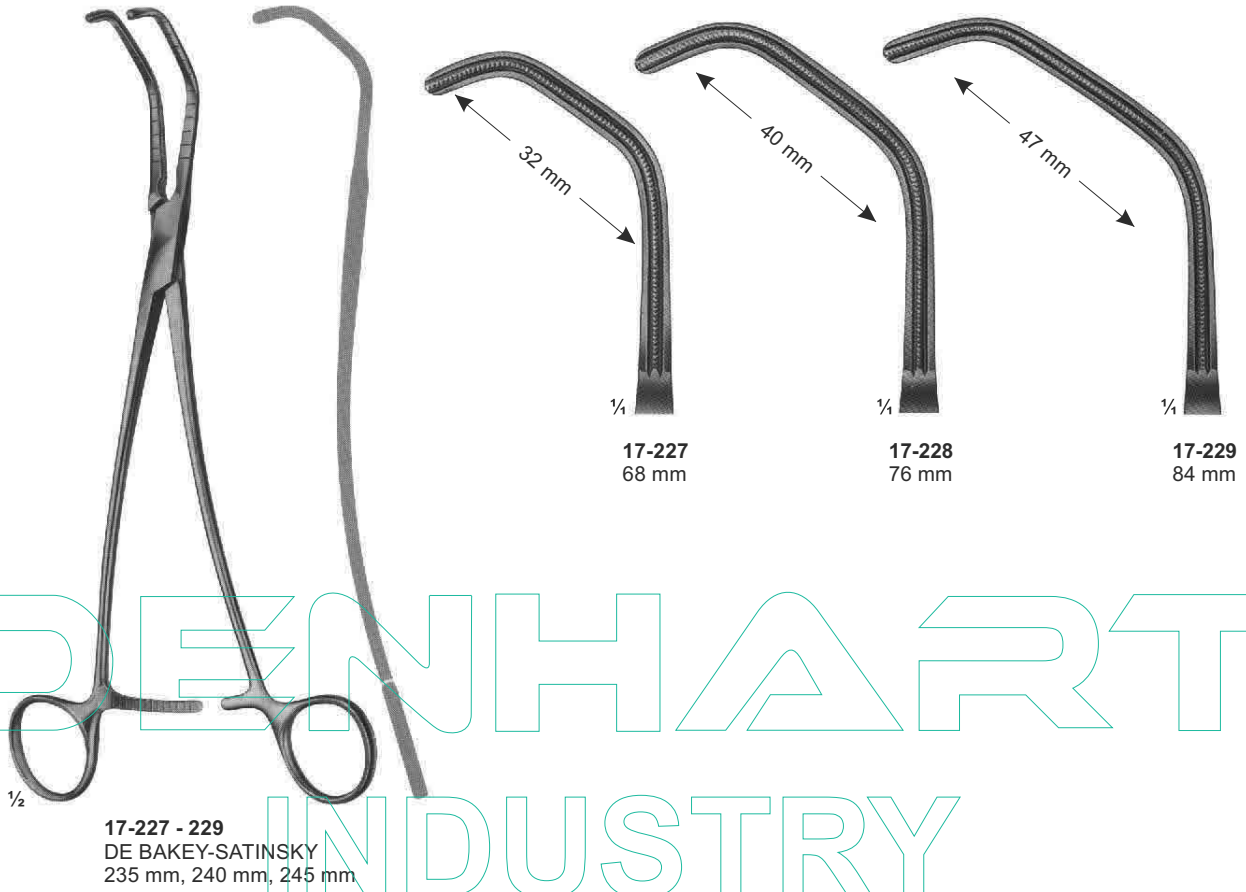

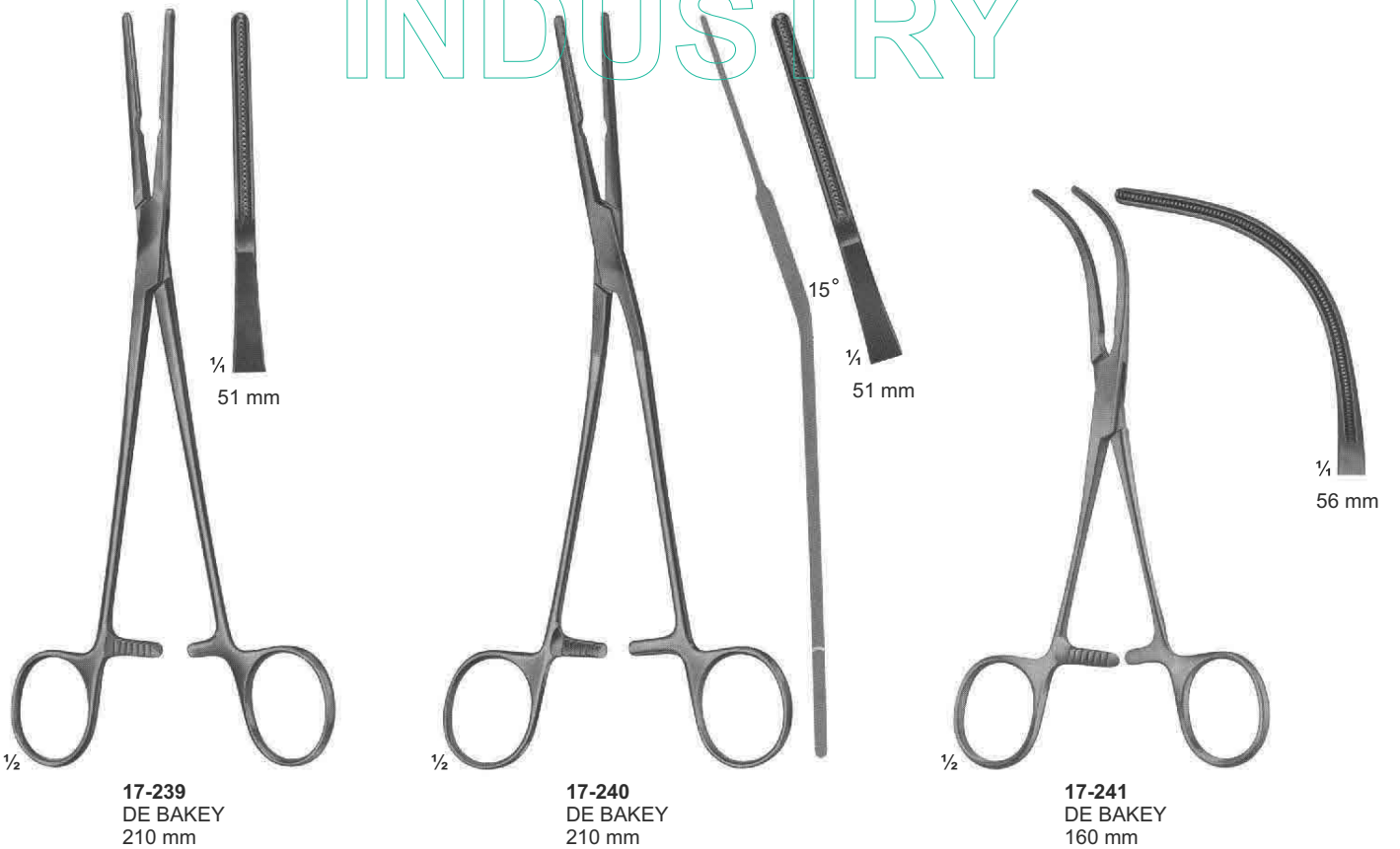
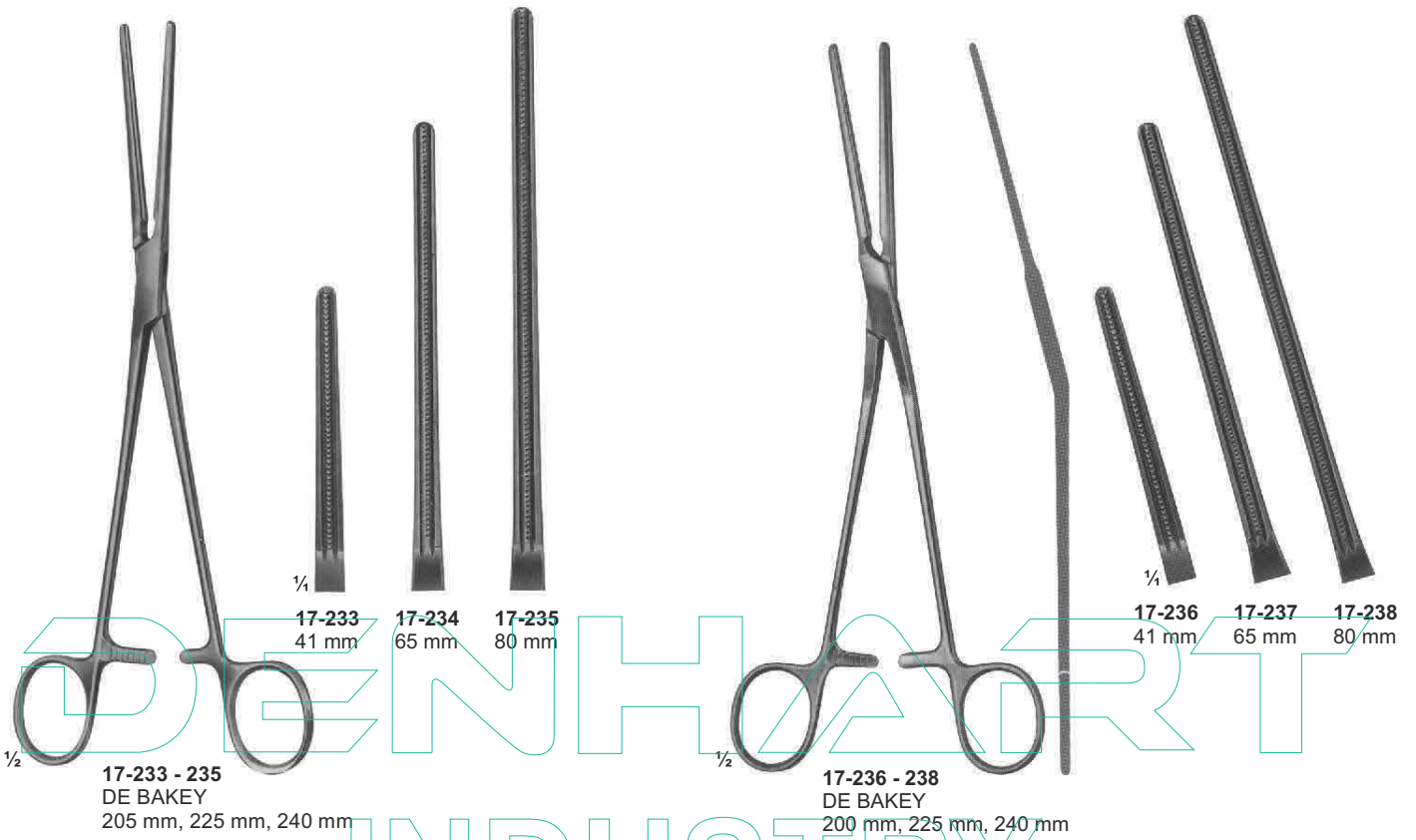

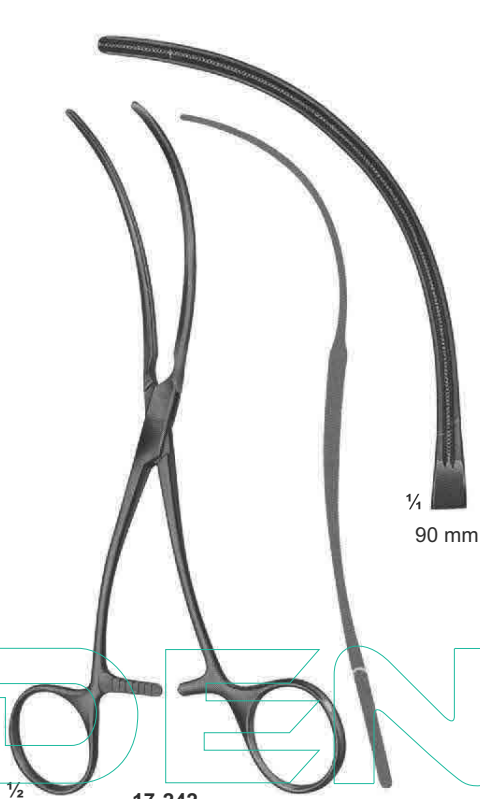

17-242
DE BAKEY
190 mm

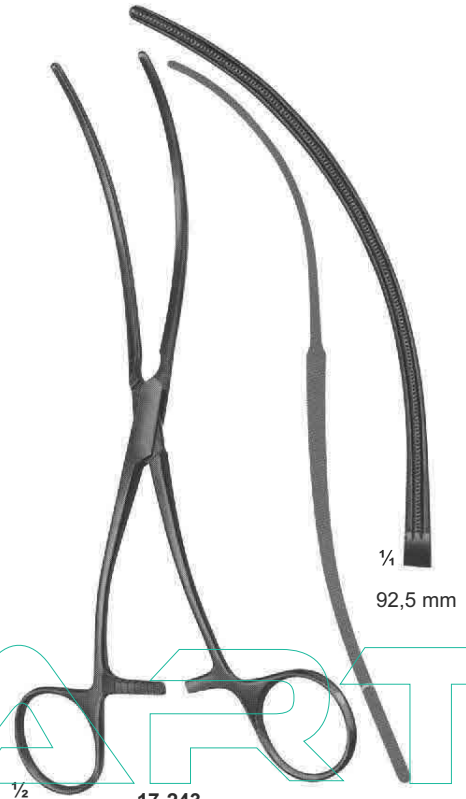

17-243
DE BAKEY
200 mm

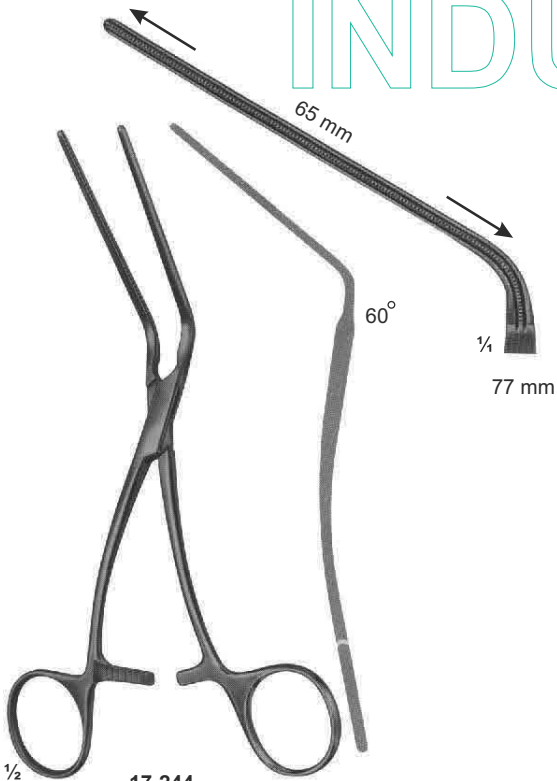

17-244
DE BAKEY
180 mm

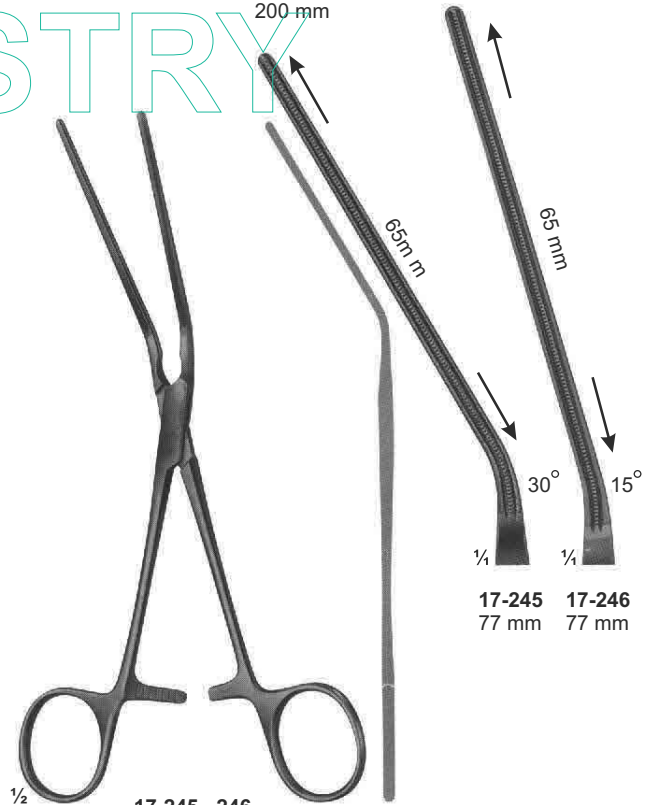

17-245 77 mm
17-246 77 mm

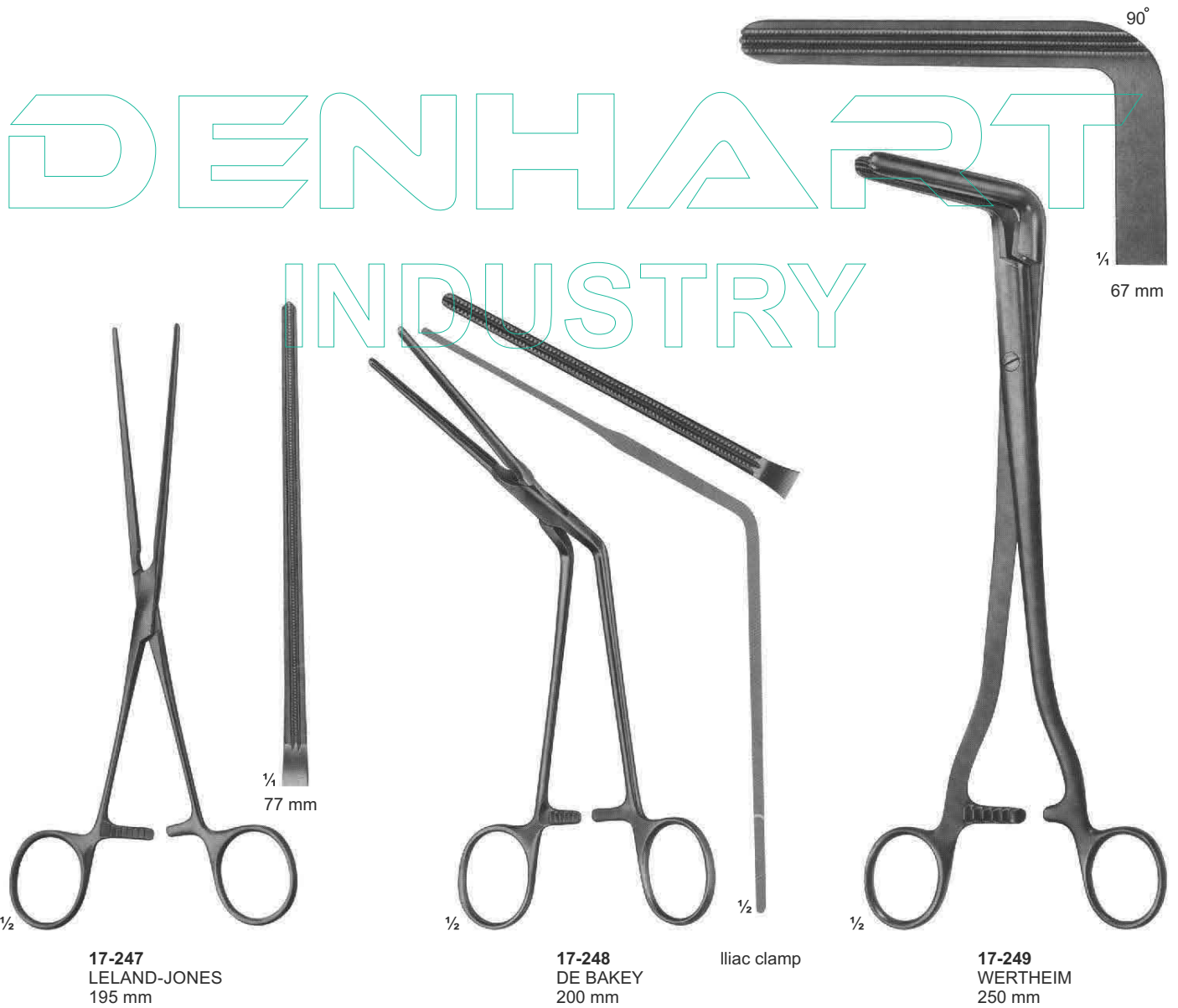

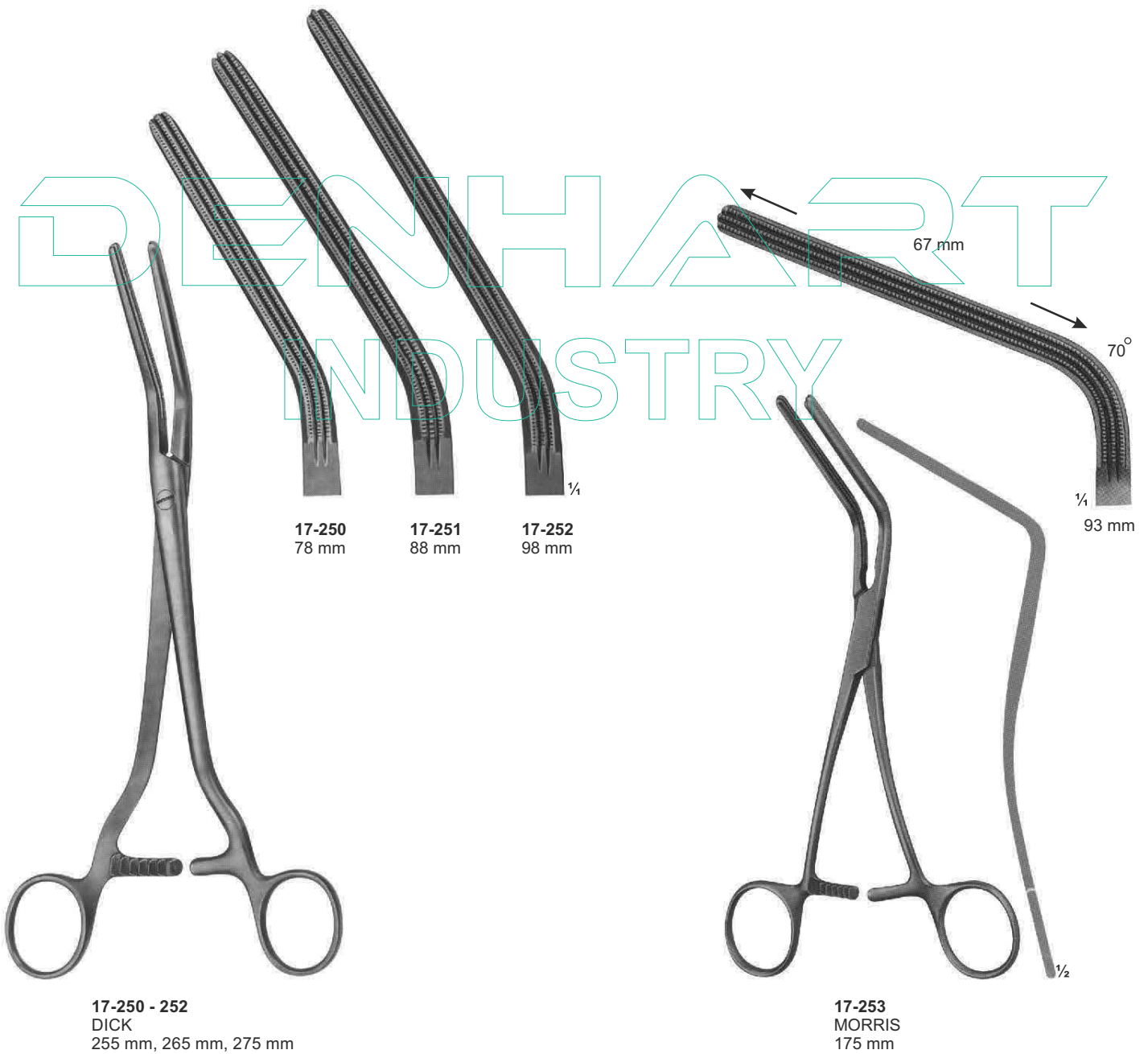

17-250 - 252
DICK
255 mm, 265 mm, 275 mm

17-253
MORRIS
175 mm

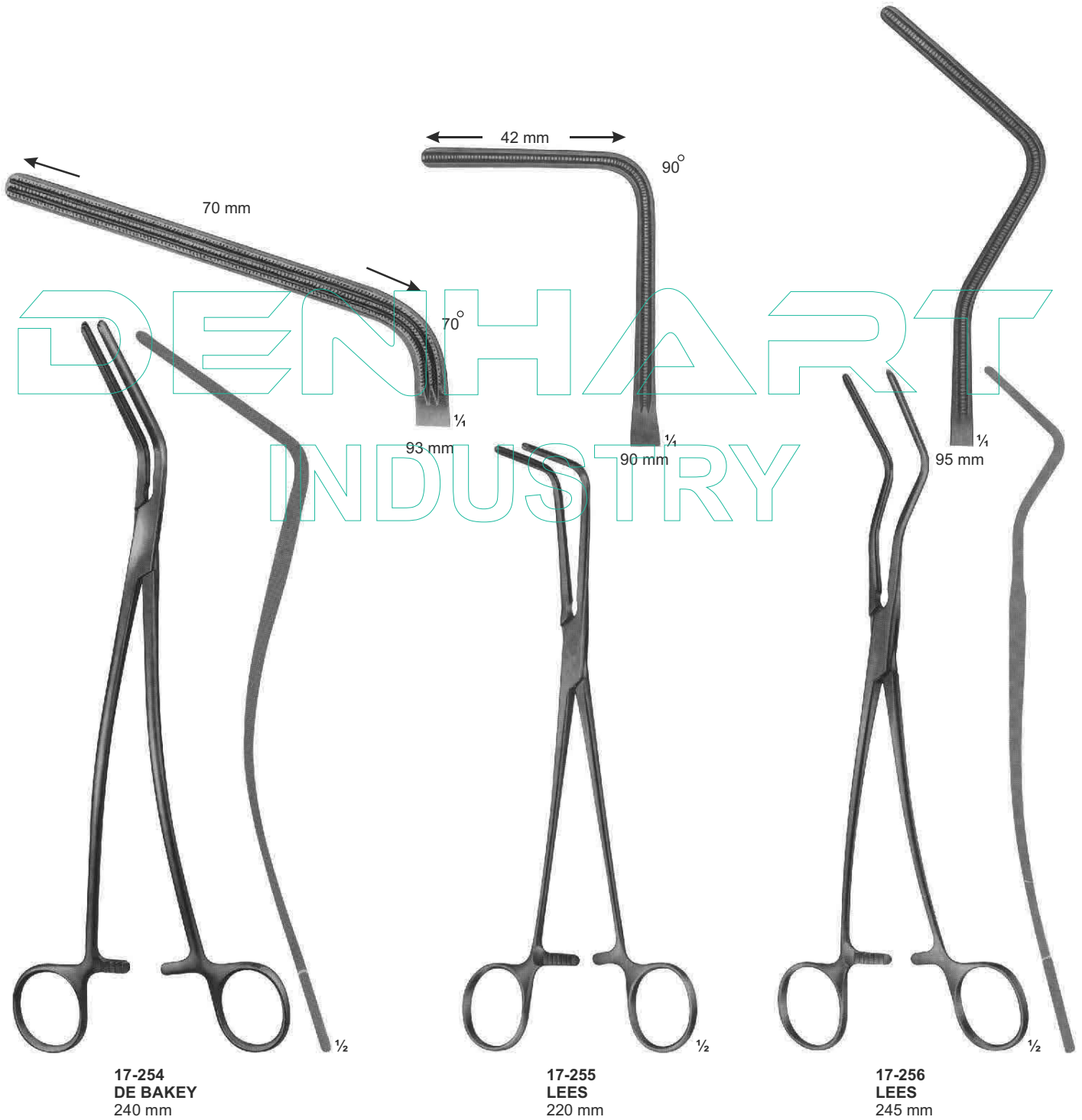

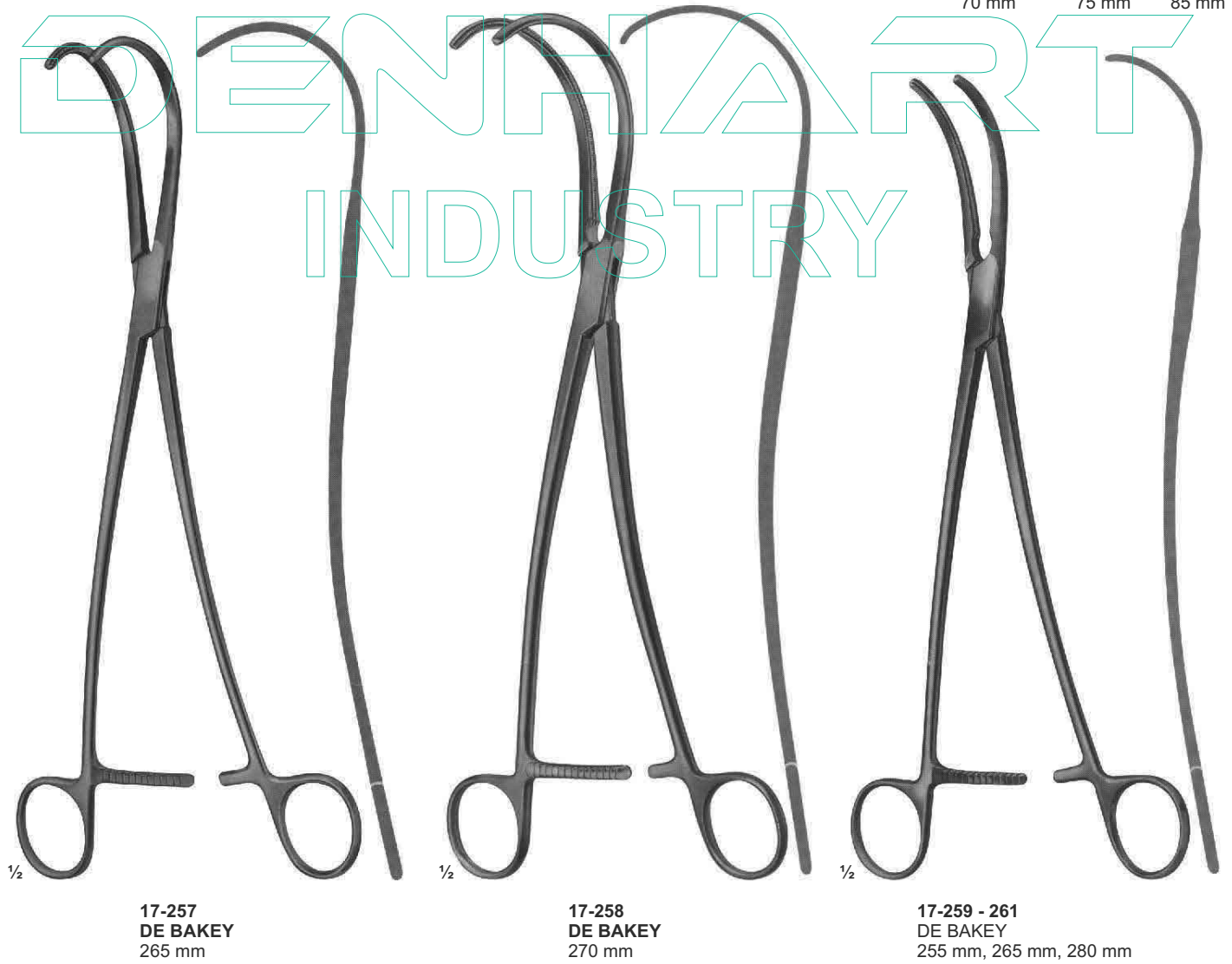
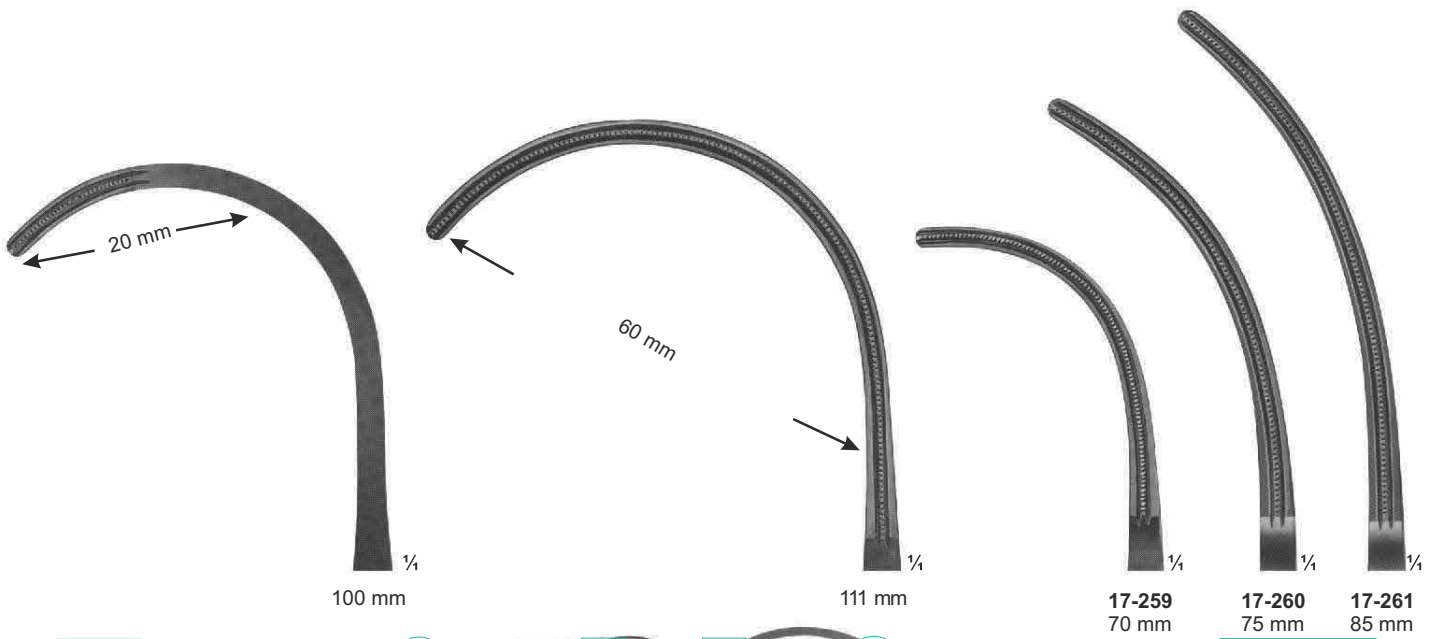

17-257
DE BAKAY
265 mm

17-258
DE BAKAY
270 mm

17-259 - 261
DE BAKAY
255 mm, 265 mm, 280 mm



17-262 - 265
DE BAKEY
250 mm, 300 mm,
315 mm, 330 mm

17-262 95 mm
17-263 110 mm
17-264 130 mm
17-265 140 mm

17-266
DE BAKEY
300 mm

DENHART INDUSTRY



**17-267
DIETRICH**
210 mm

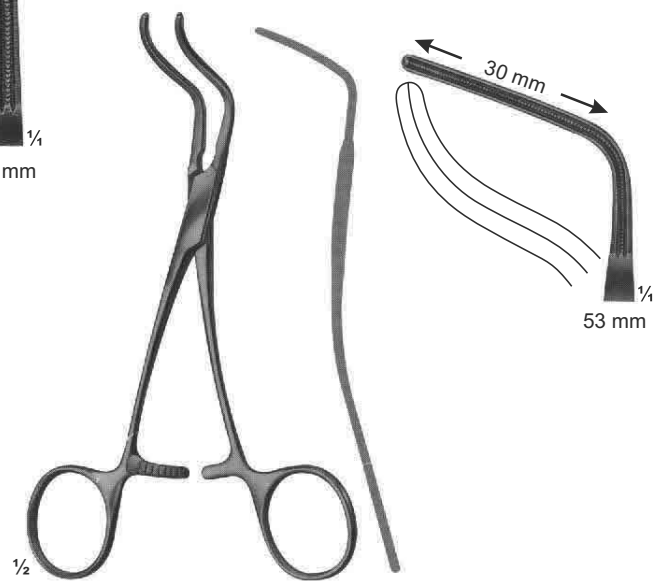

**17-268
SUBRAMANIAN**
155 mm

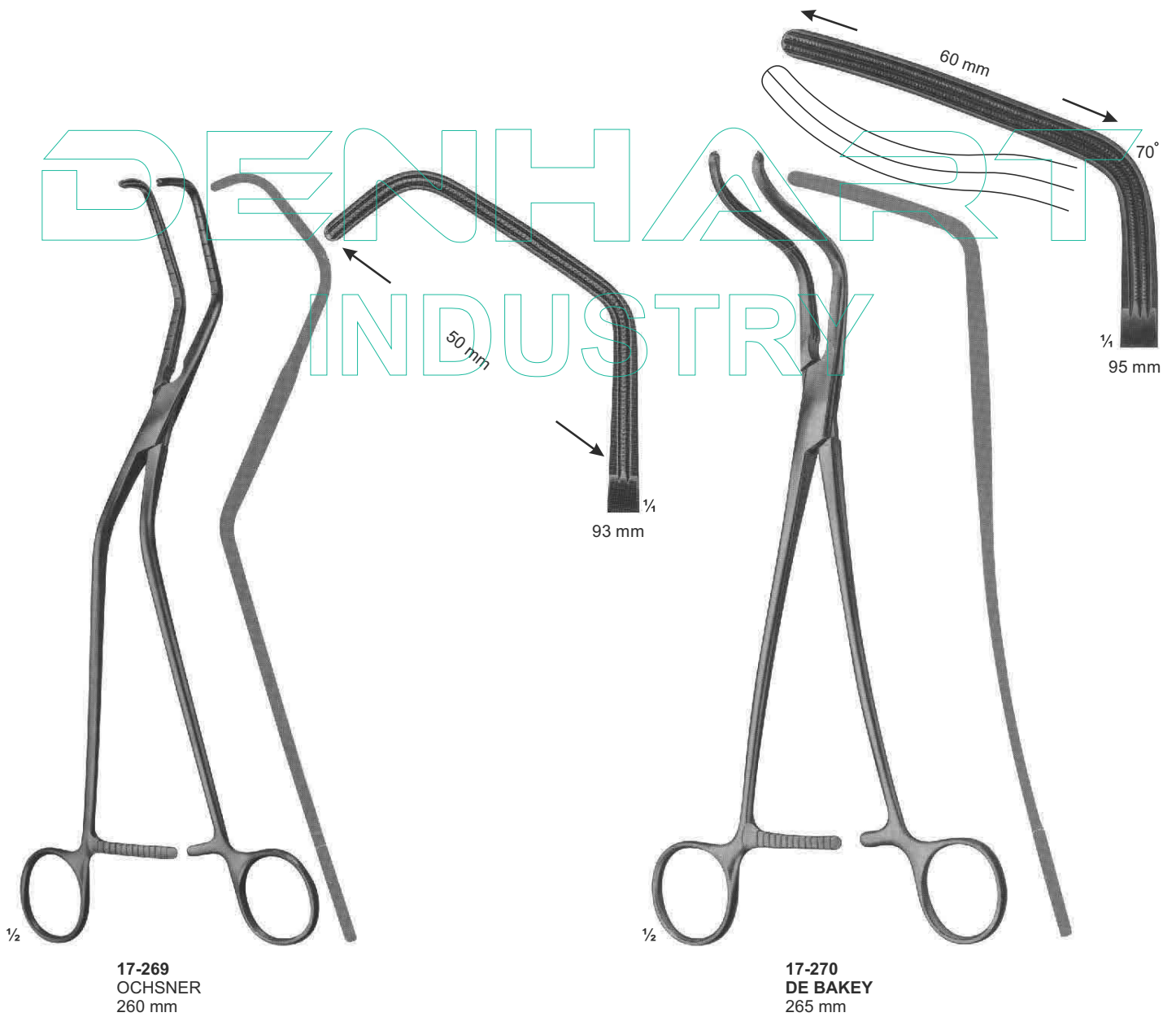

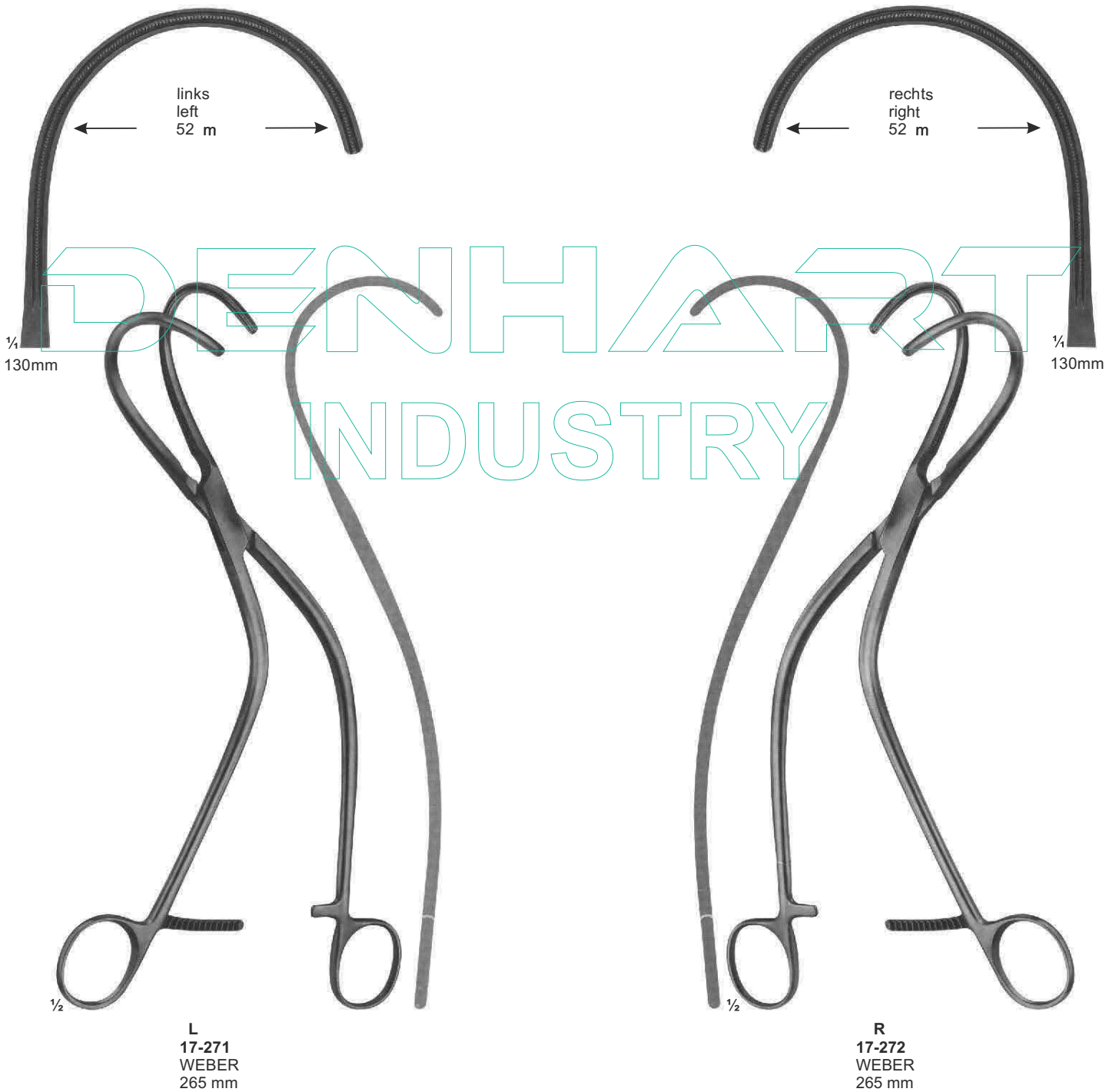



17-273 - 276
DE BAKY

1/2

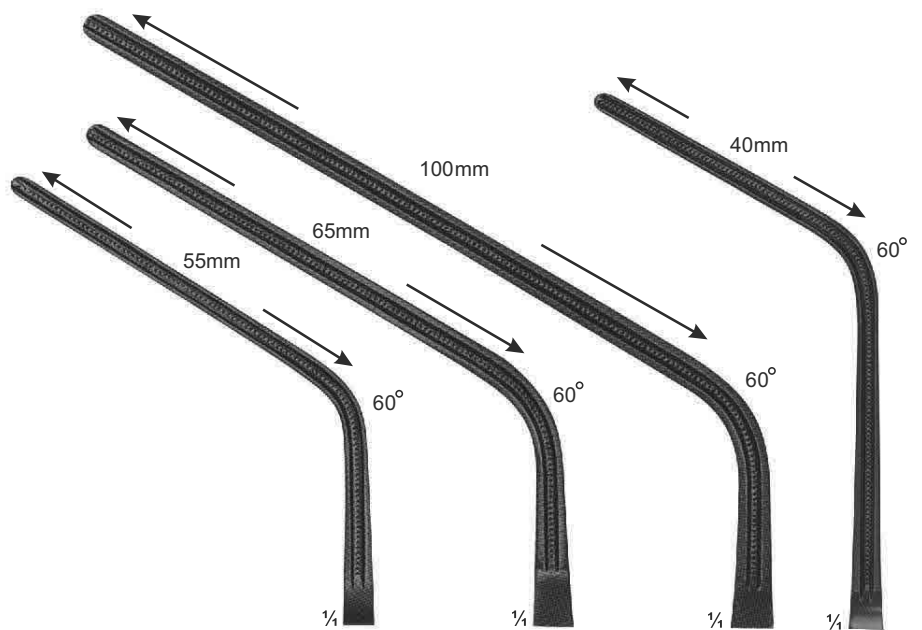

17-273

17-274

17-275

17-276

Total Length:

230 mm

280 mm

305 mm

240 mm

Length of jaws:

85 mm

100 mm

135 mm

93 mm



17-277 - 280
DE BAKY

1/2

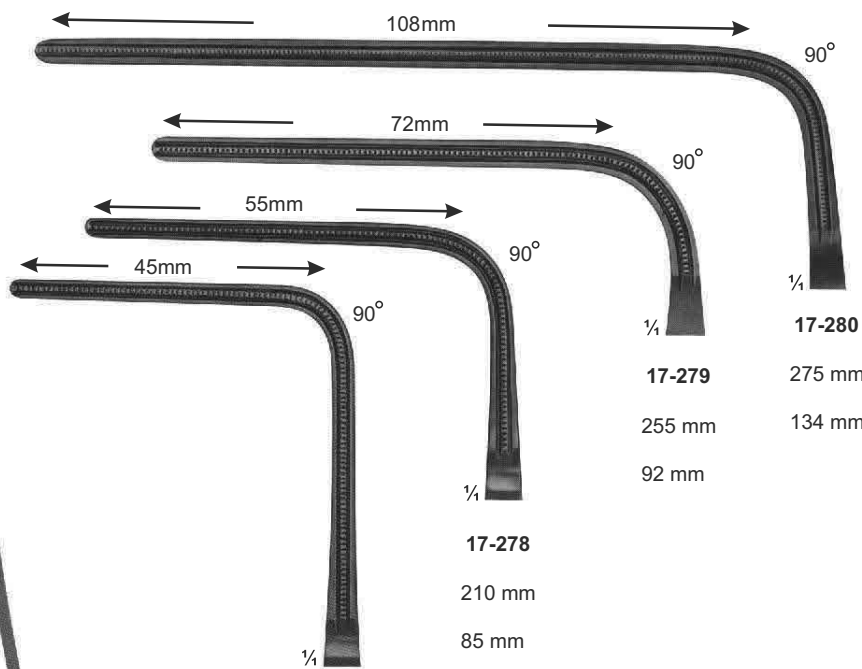

17-277

17-278

17-279

17-280

Total Length:

225 mm

Length of jaws:

93 mm

275 mm

255 mm

210 mm

134 mm

85 mm

92 mm

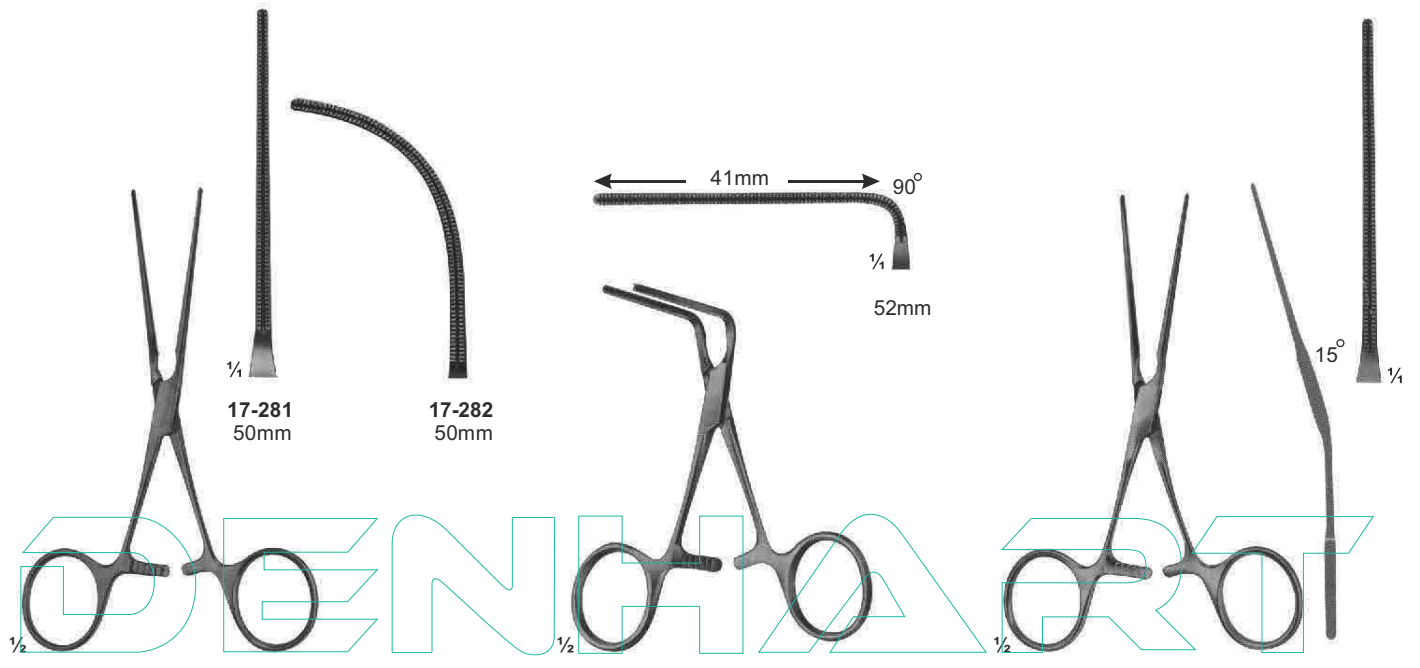

17-281 - 282
COOLEY
125 mm, 115 mm

17-283
COOLEY
100 mm

17-284
COOLEY
125 mm

INDUSTRY

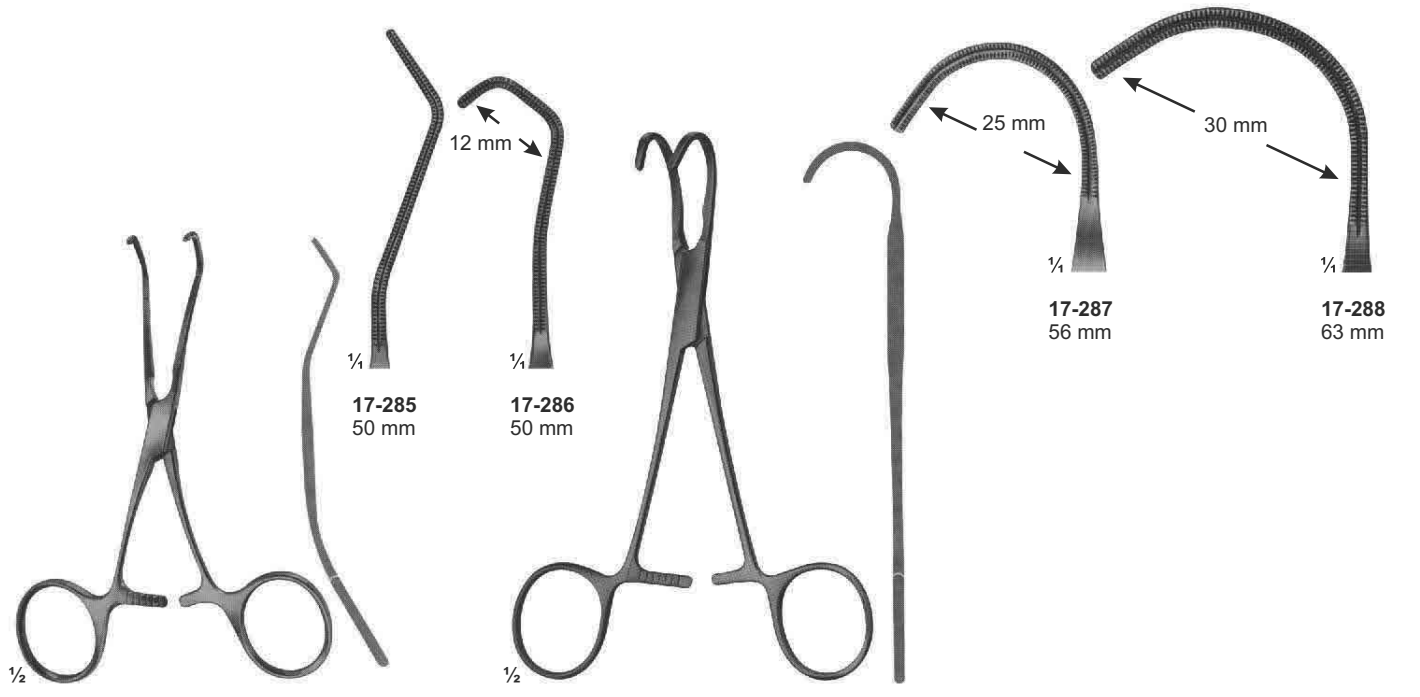

17-285 - 286
COOLEY
120 mm, 115 mm

17-287 - 288
COOLEY-BACK
150 mm, 115 mm

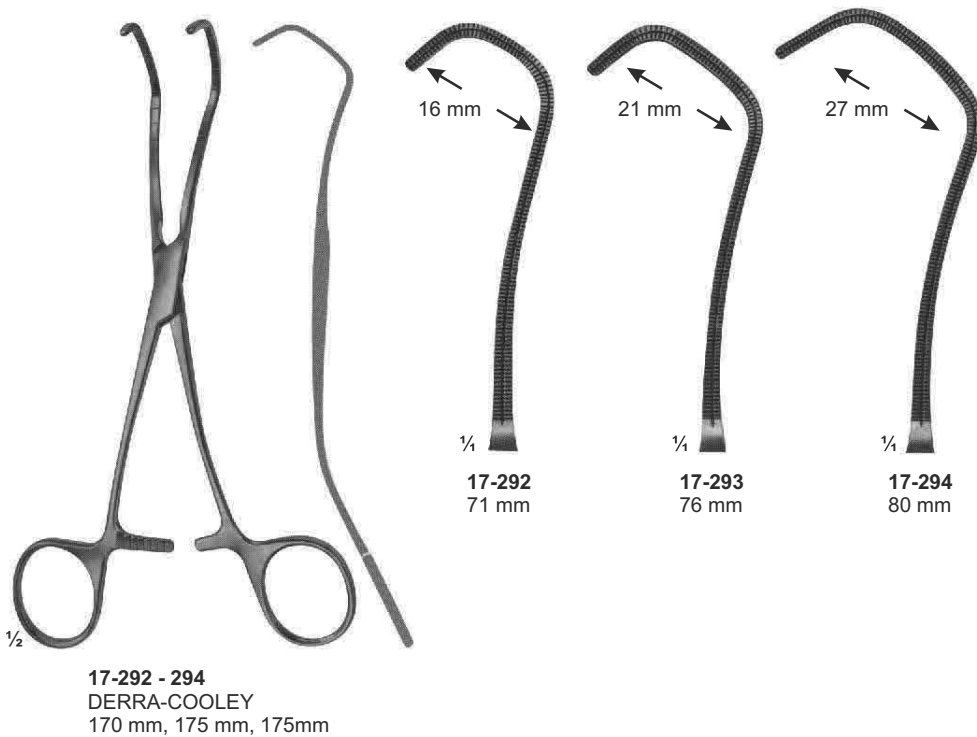
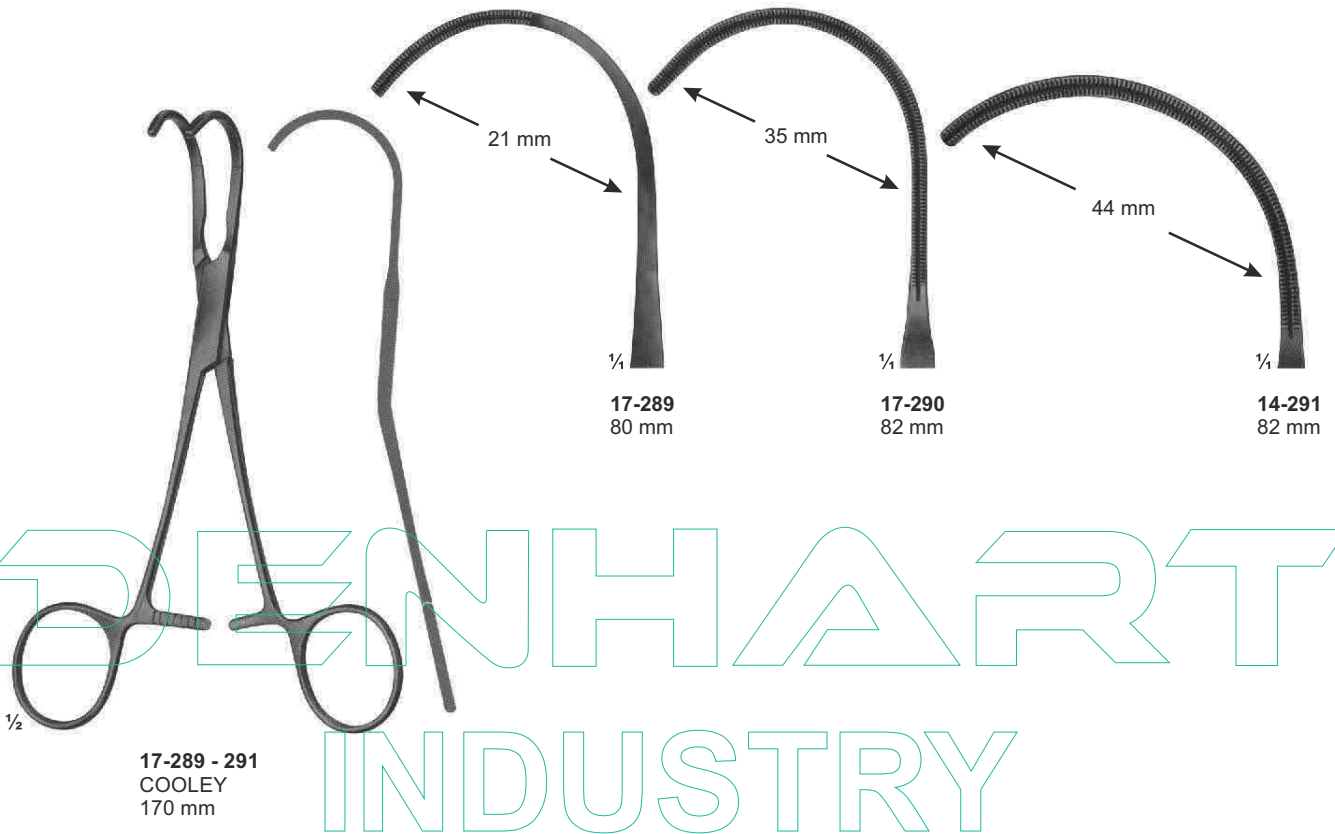

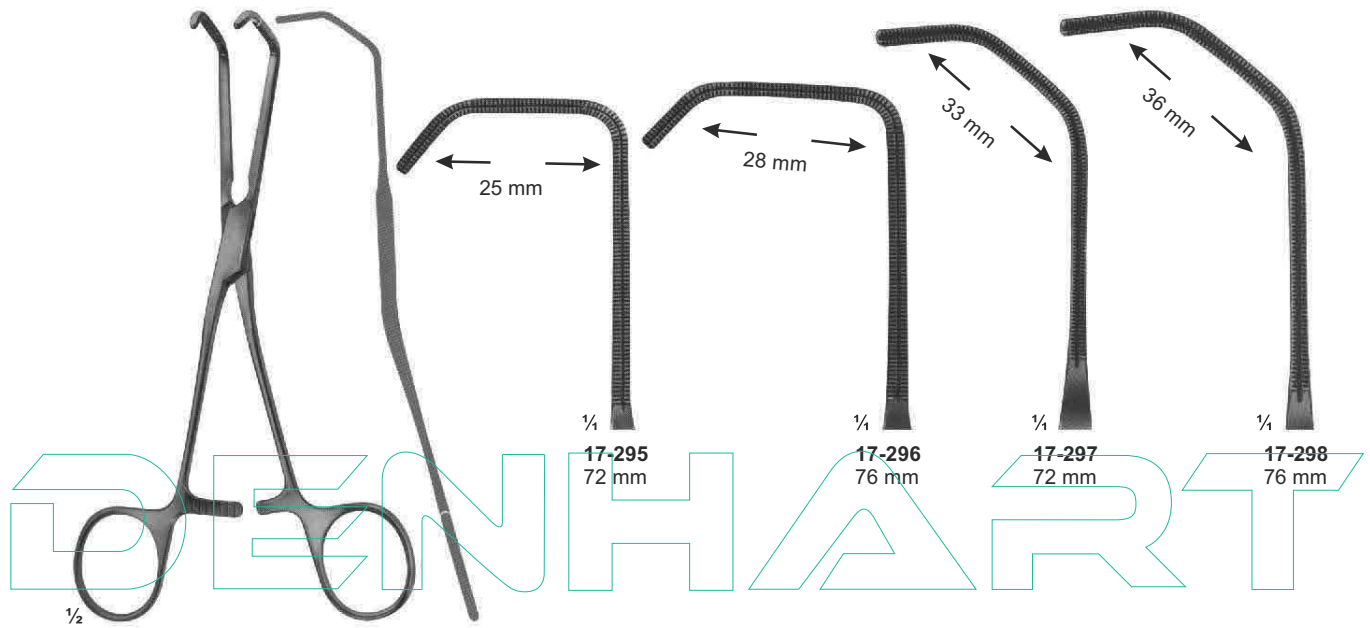

17-295 - 298
COOLEY
165 mm, 165 mm
175 mm, 180 mm

INDUSTRY

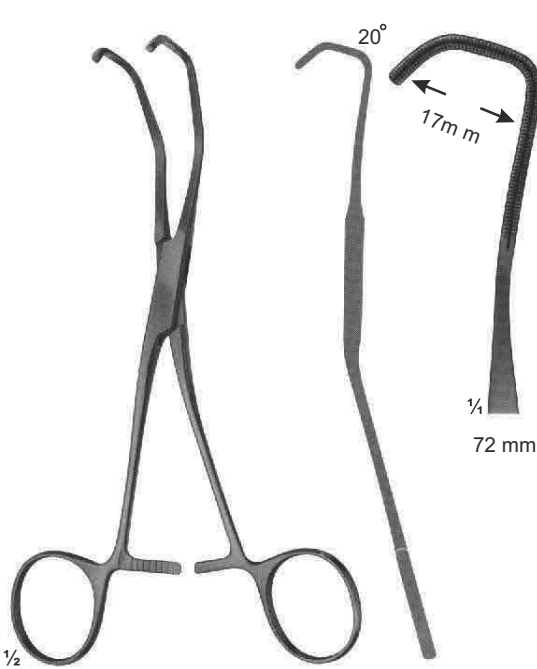

17-299
COOLEY
170 mm

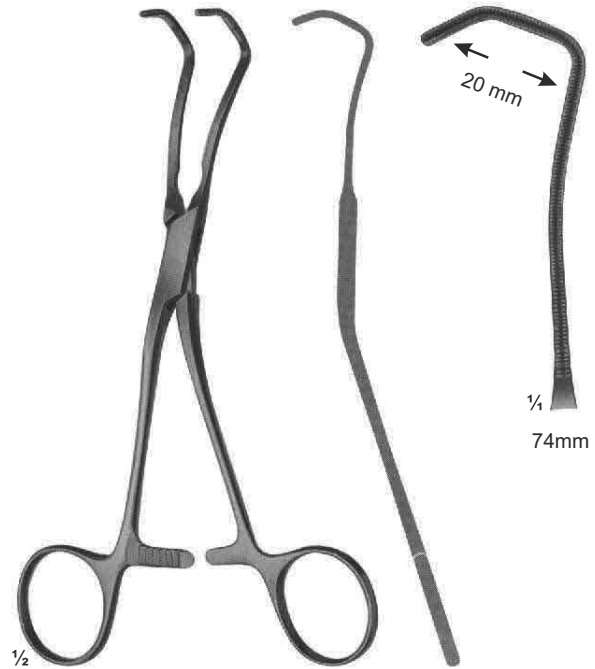

17-300
COOLEY
175 mm

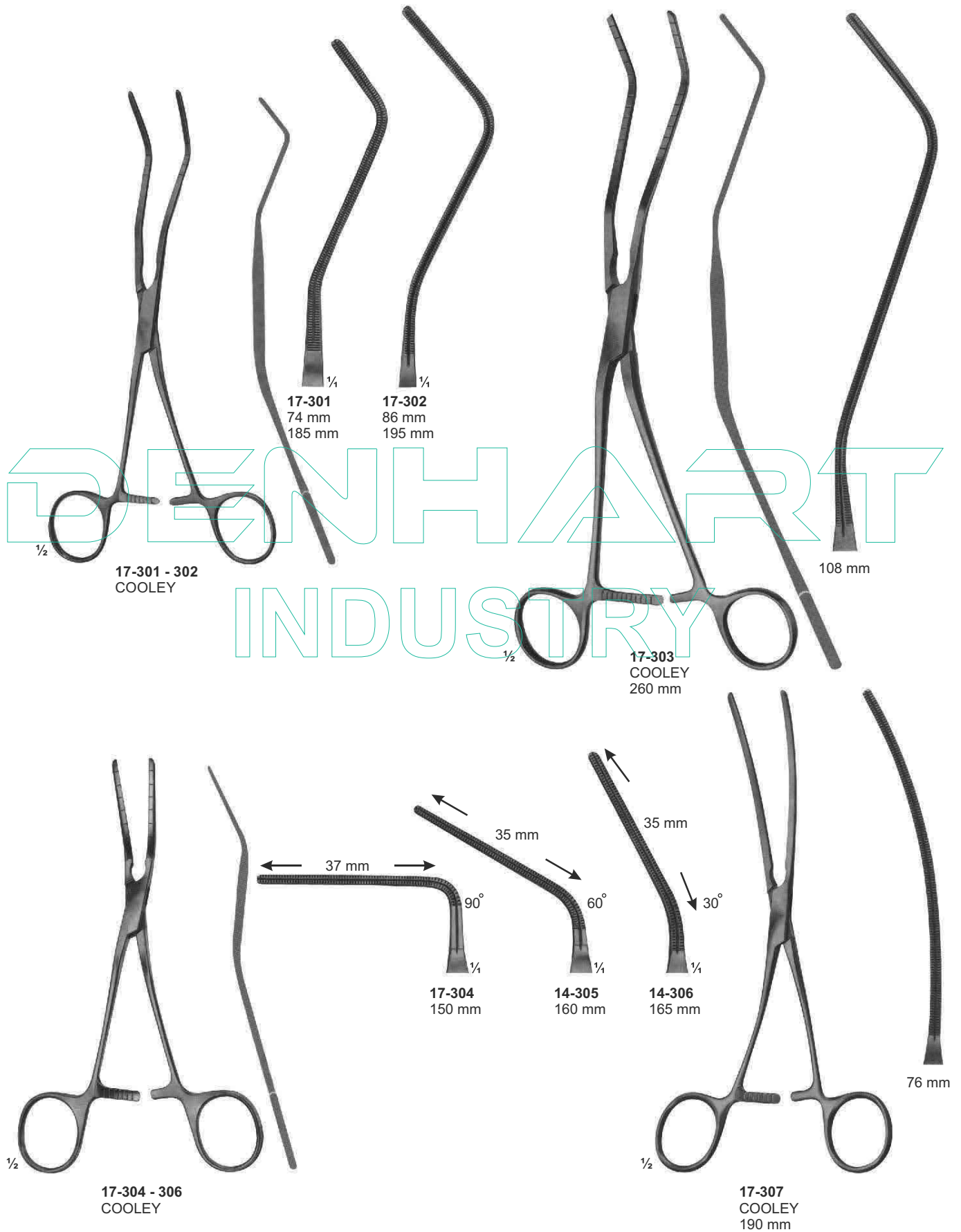

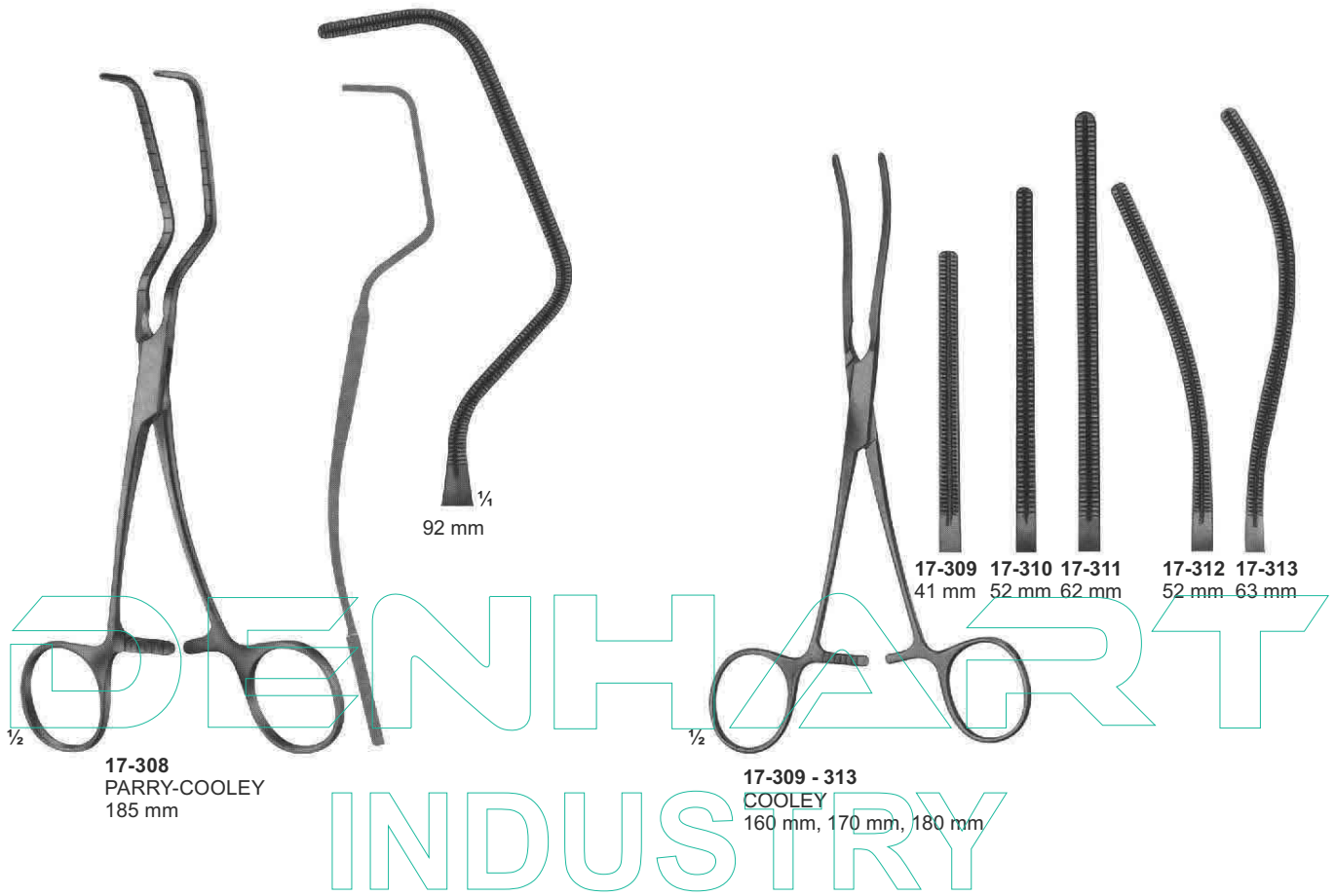

17-308
PARRY-COOLEY
185 mm

17-309 - 313
COOLEY
160 mm, 170 mm, 180 mm

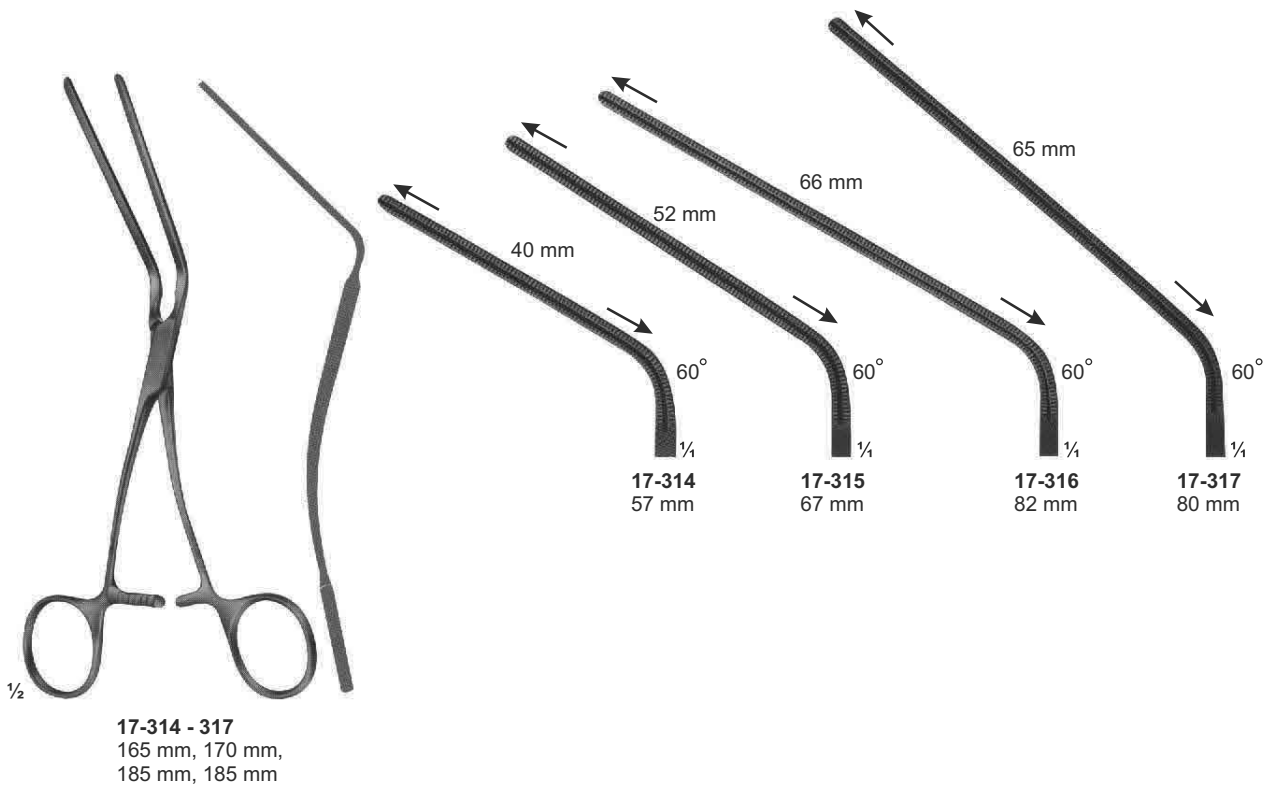

17-314 - 317
165 mm, 170 mm,
185 mm, 185 mm

17-314
57 mm

17-315
67 mm

17-316
82 mm

17-317
80 mm

DENHART INDUSTRY



DARDIK			
17-318	150 mm	17-323	170 mm
17-319	150 mm	17-324	170 mm
17-320	150 mm	17-325	170 mm
17-321	145 mm	17-326	160 mm
17-322	130 mm	17-327	135 mm

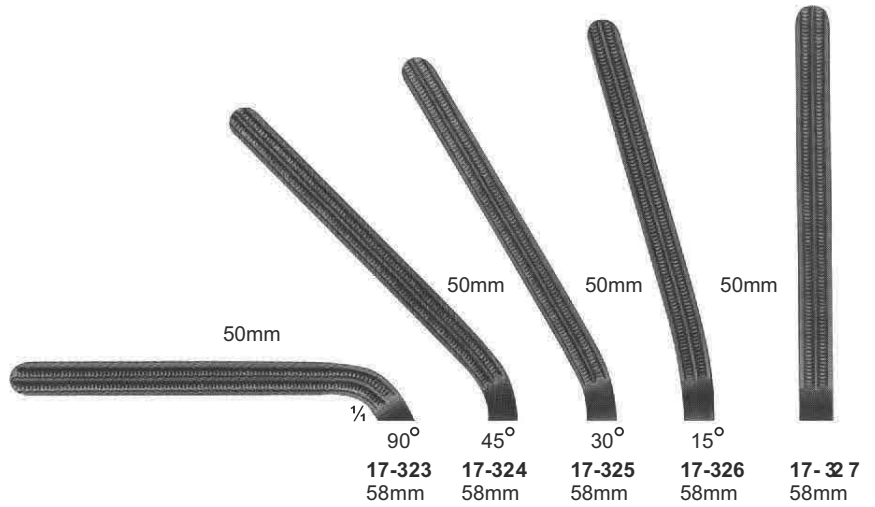
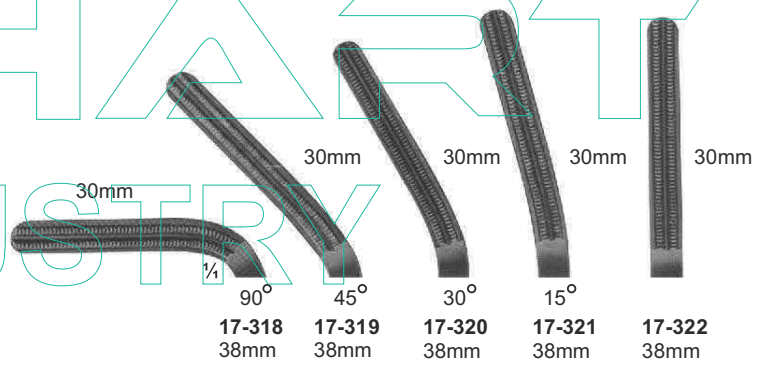

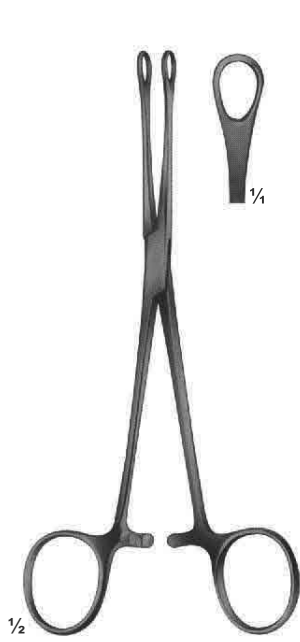

17-328
WILLIAMS
160 mm



17-329
TUTTLE
230 mm



17-330
NELSON
230 mm



17-331
DUVAL
230 mm

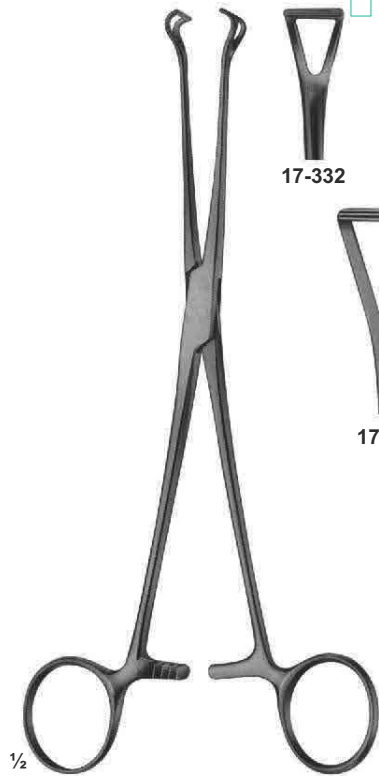

BABCOCK
17-332 170 mm
17-333 215 mm
17-334 220 mm

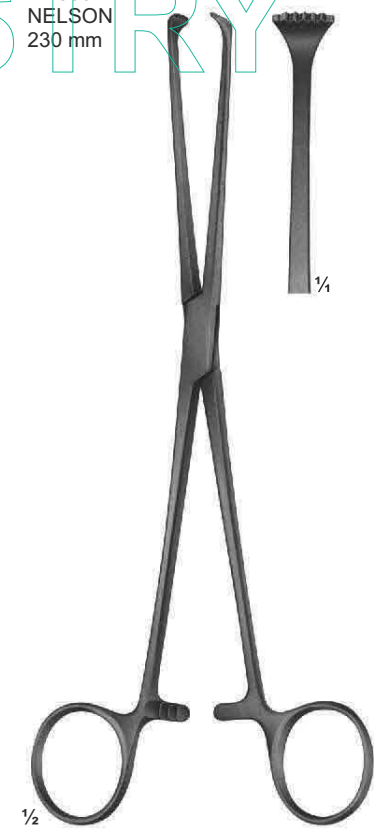
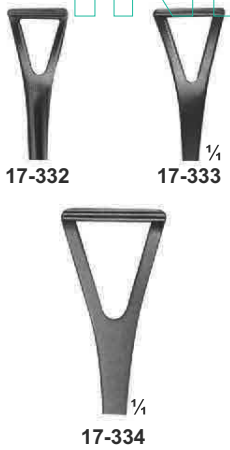

17-335
ALLIS
220 mm

DENHART
INDUSTRY

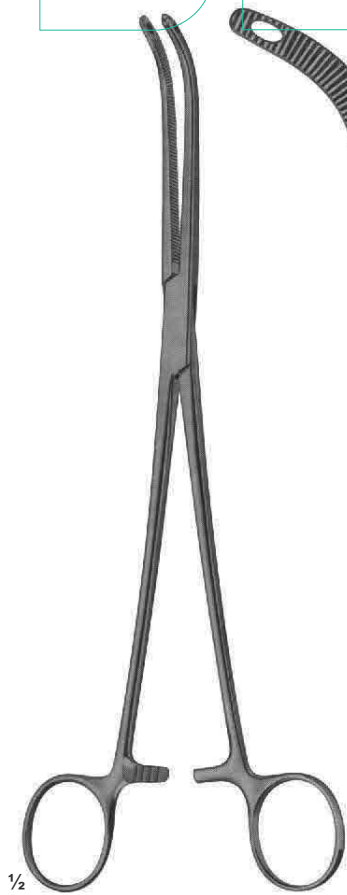

17-336
FINOCHIETTO
245 mm

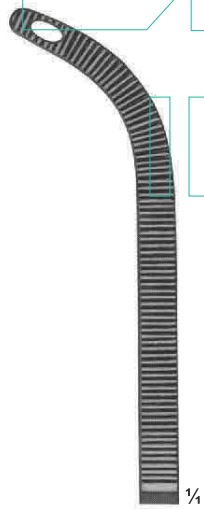

17-337 - 338
SEMB
244 mm



17-337



17-338

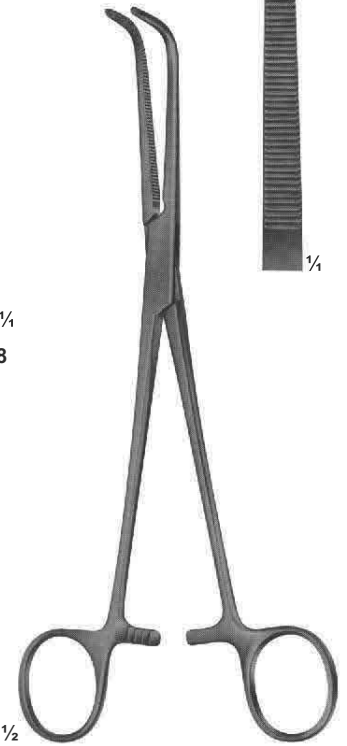

17-339
WIKSTROEM
205 mm

DENHART
INDUSTRY



17-340
MIXTER
230 mm

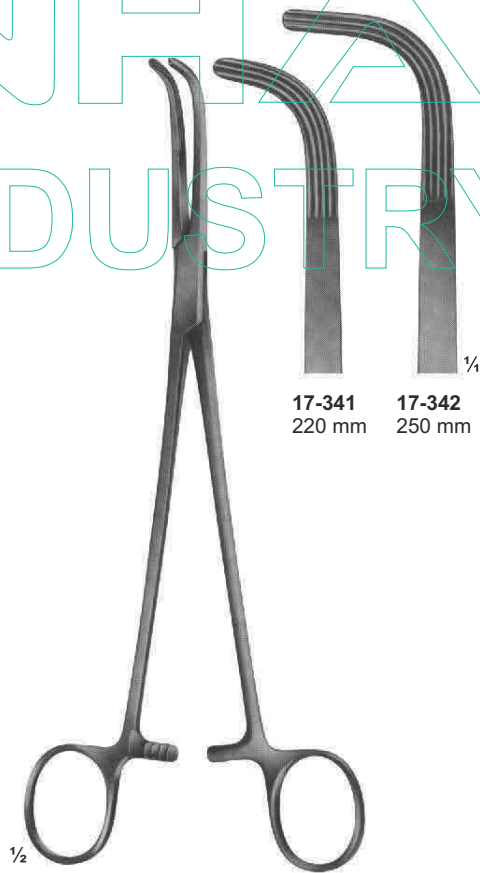

17-341 220 mm
17-342 250 mm

17-341 - 342
MIXTER

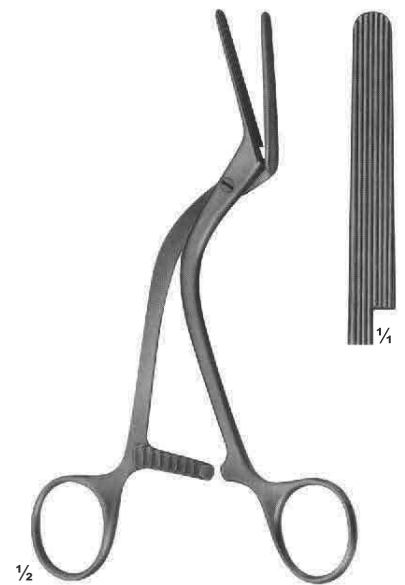

17-343
HOPFNER
160 mm

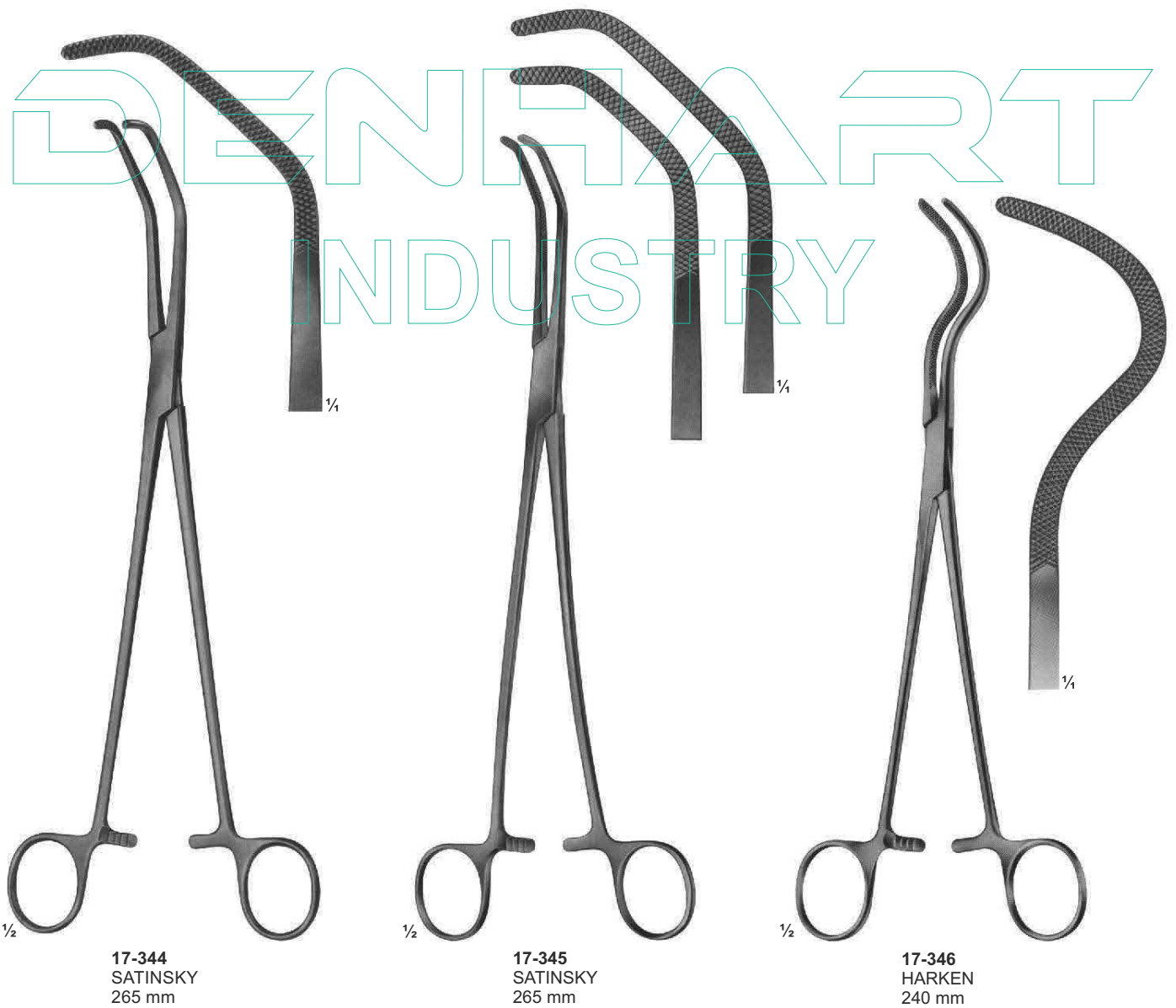

DENHART
INDUSTRY



17-347
PERTUISET
Carotid Clamp
90 mm

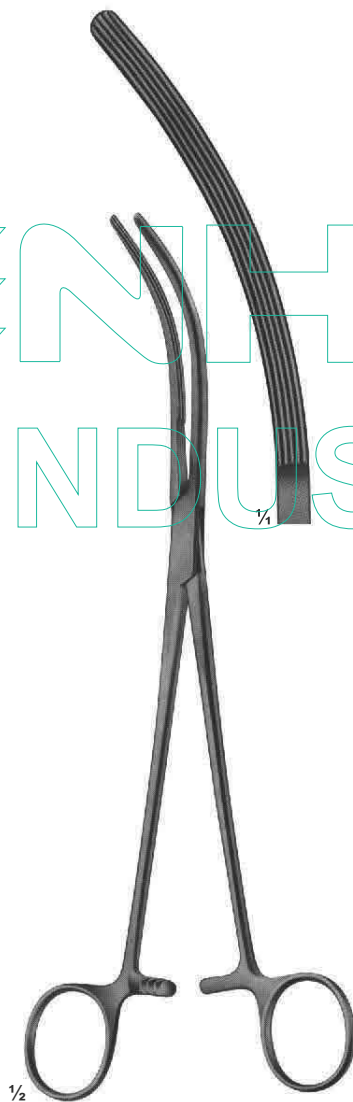

17-348
CRAFOORD-SELLORS
240 mm

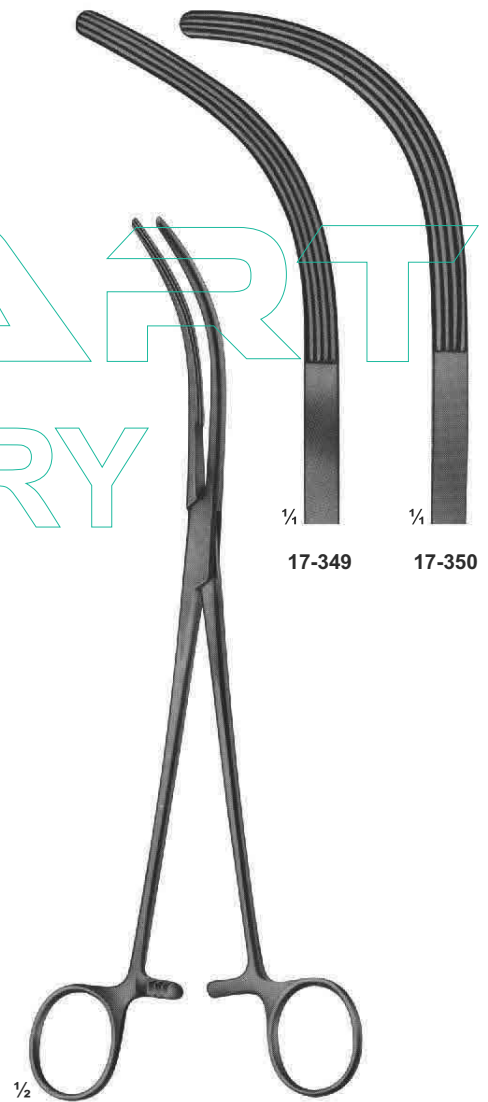

17-349 - 350
CRAFOORD
240 mm

DENHART
INDUSTRY



17-351
PRICE THOMAS
225 mm

¼

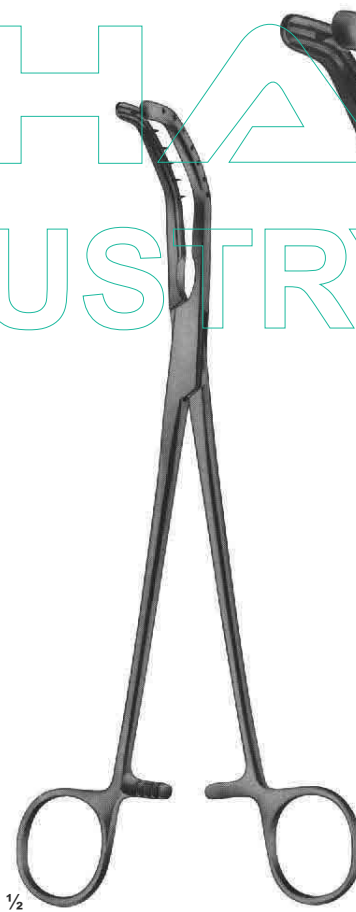

17-352 - 353
PRICE THOMAS
225 mm

½



¼

17-352
jaws with pins

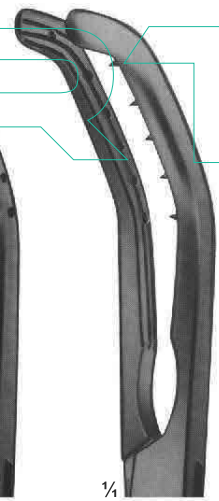

¼

17-353
jaws with pins



17-354
SCHUMACHER
Sternum shears
210 mm



17-355
LEBSCHKE
Sternum chisel
200 mm



17-356
230 mm



17-357
COLLIN
195 mm

DENHART
INDUSTRY



17-358
GLUCK
190 mm



17-359
GLUCK
190 mm



17-360
BRUNNER
Universal Pattern
340 mm



17-361
GIERTZ-STILLE
250 mm

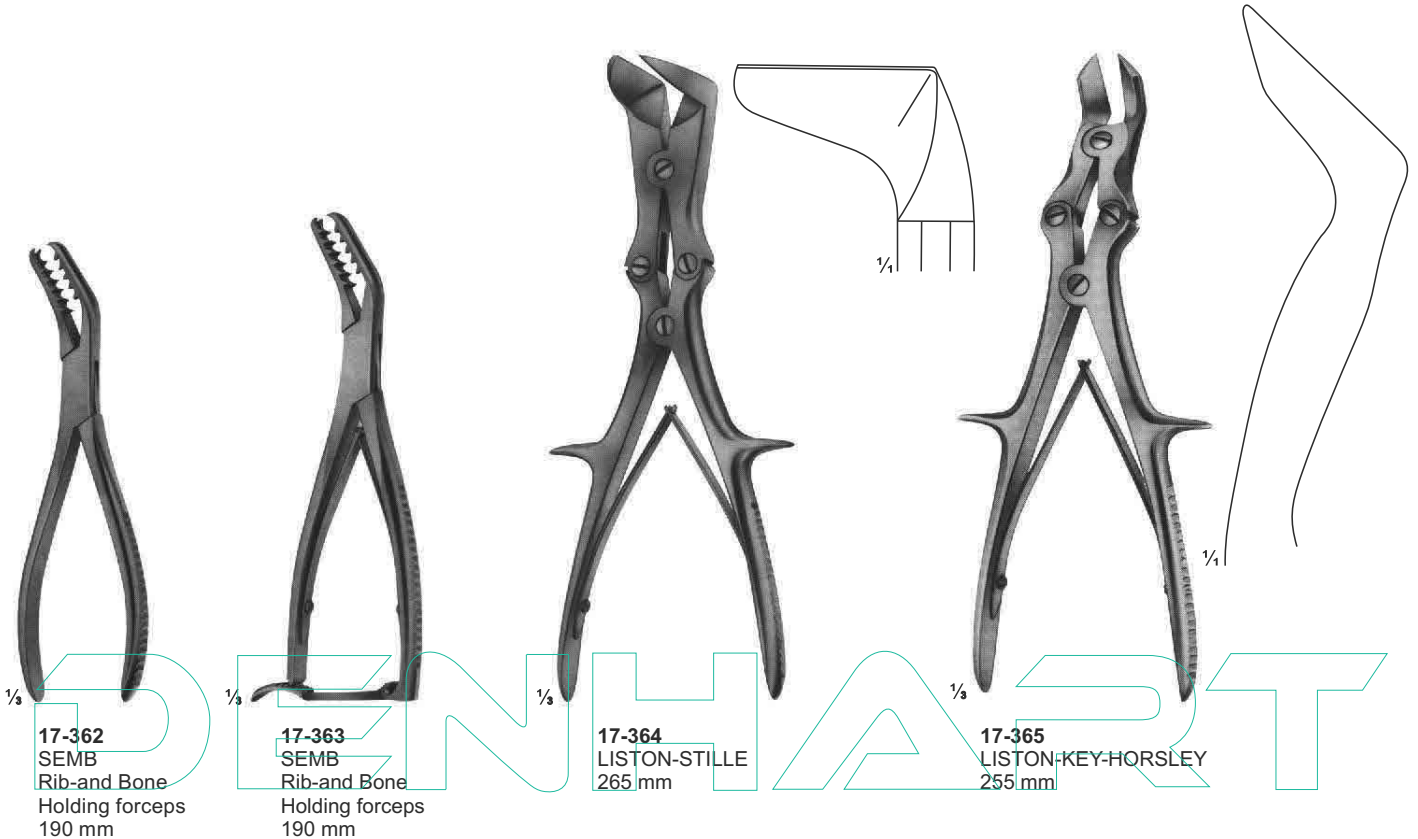

17-362
SEMB
Rib-and Bone
Holding forceps
190 mm

17-363
SEMB
Rib-and Bone
Holding forceps
190 mm

17-364
LISTON-STILLE
265 mm

17-365
LISTON-KEY-HORSLEY
255 mm

INDUSTRY

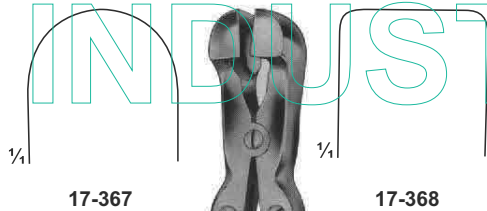

17-367

17-368

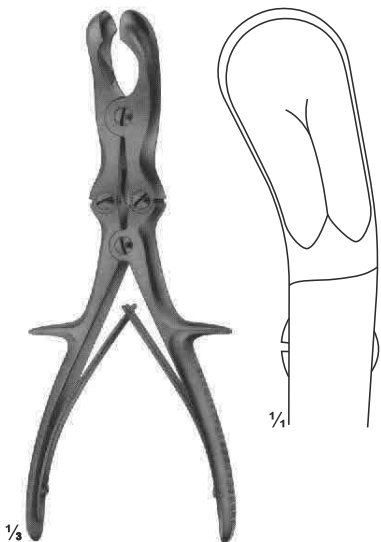

17-366
SEME
Rib Rongeur to shorten
the rib stumps
240 mm



17-367-368
SAUERDRUCH-CORYLLOS
Rib rongeurs to shorten
the rib stumps
310 mm

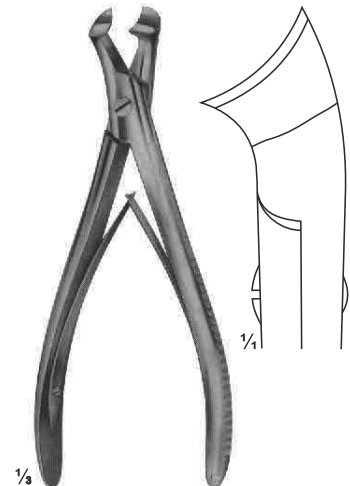

17-369
MARKWALDER
Rib Rongeur to Round
the rib stumps
190 mm



17-370 - 371
DOYEN
for children
175 mm

17-372 - 373
DOYEN
for adults
175 mm

17-374 - 375
DOYEN
240 mm

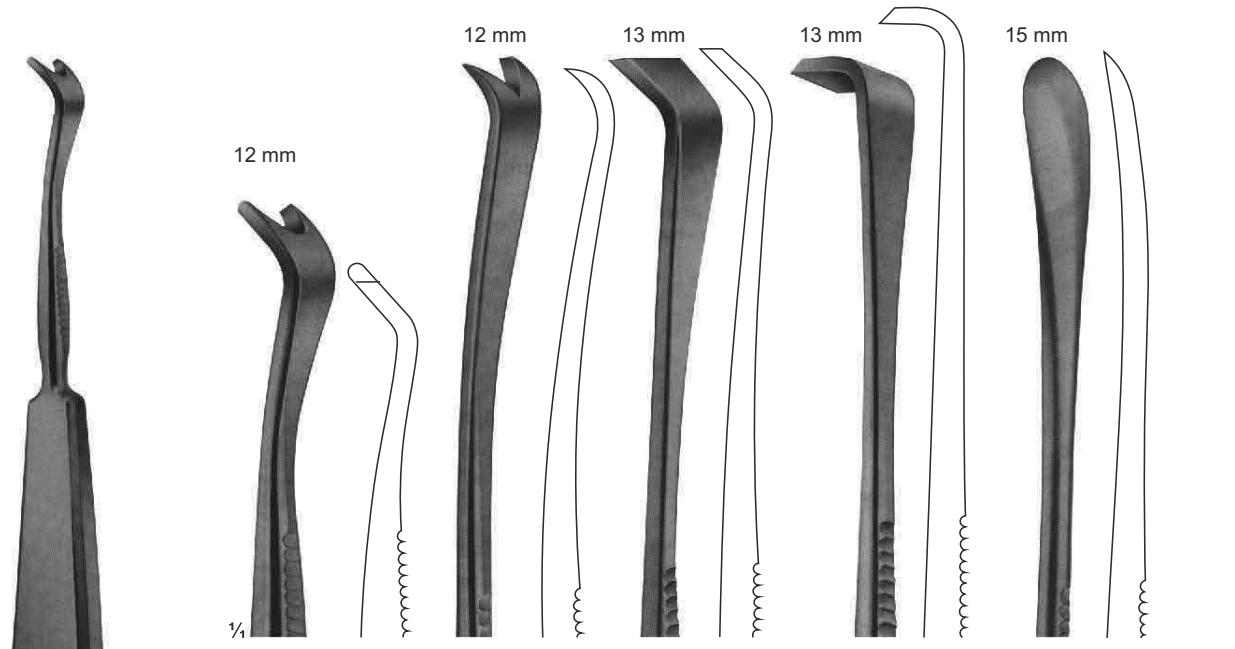

17-376
190 mm

17-377

17-378

17-379

17-380

DENHART
INDUSTRY

1/2
17-376 - 380
SEMB
230 mm

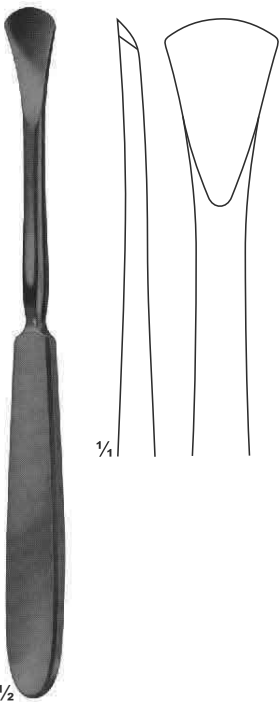

17-381
LANGENBECK
190 mm

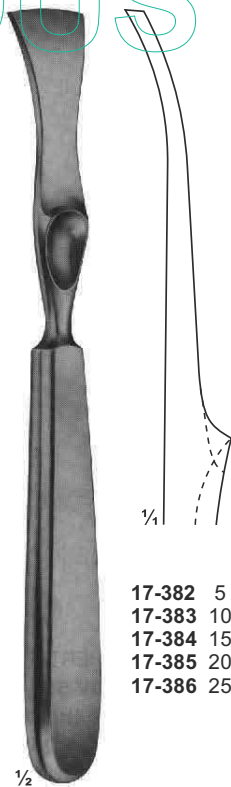

17-382 - 386
LAMBOTTE
215 mm

- 17-382 5 mm
- 17-383 10 mm
- 17-384 15 mm
- 17-385 20 mm
- 17-386 25 mm

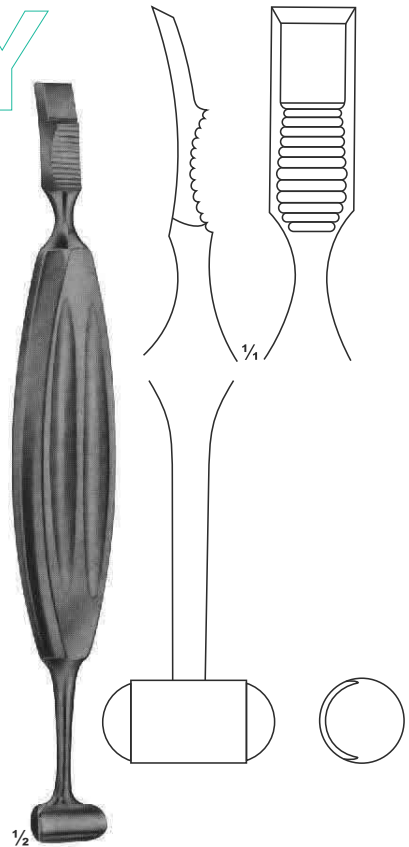

17-387
ALEXANDER
210 mm

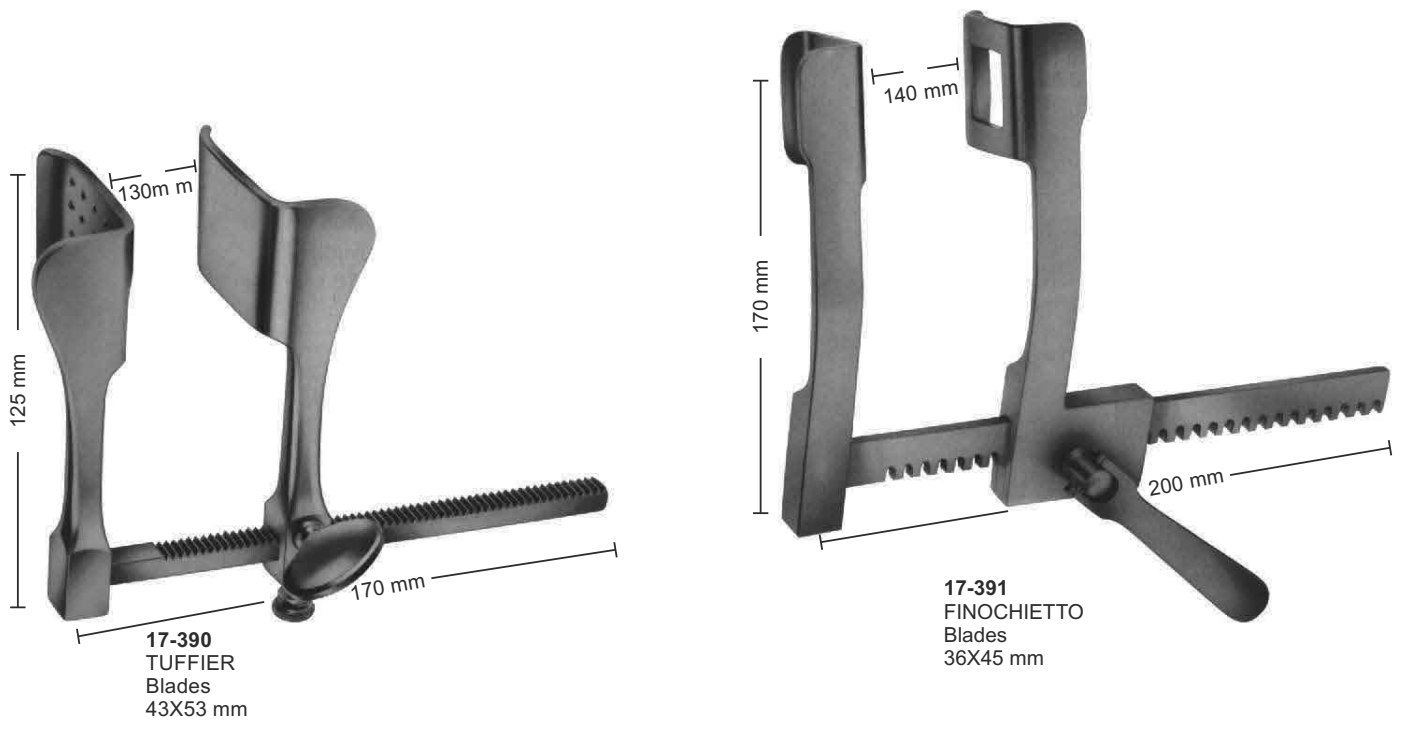
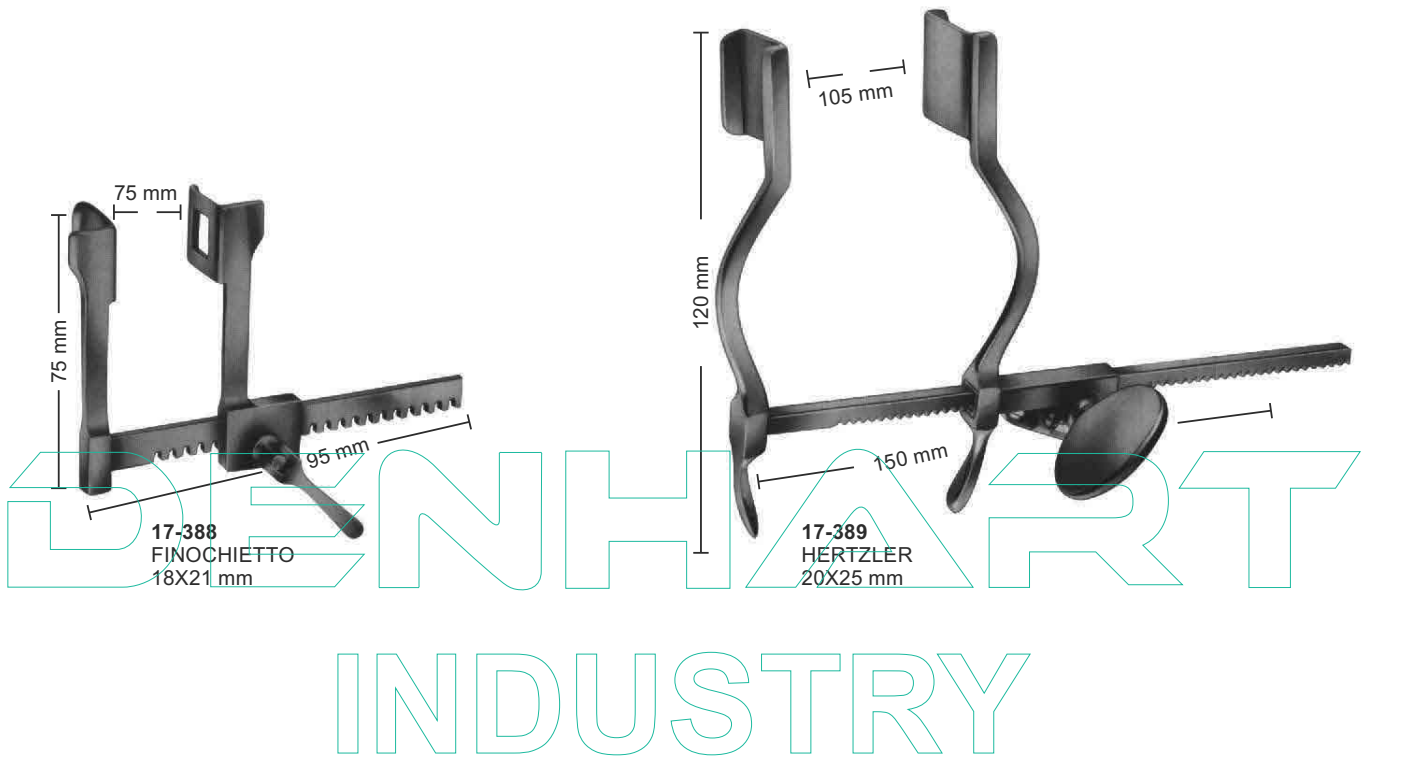

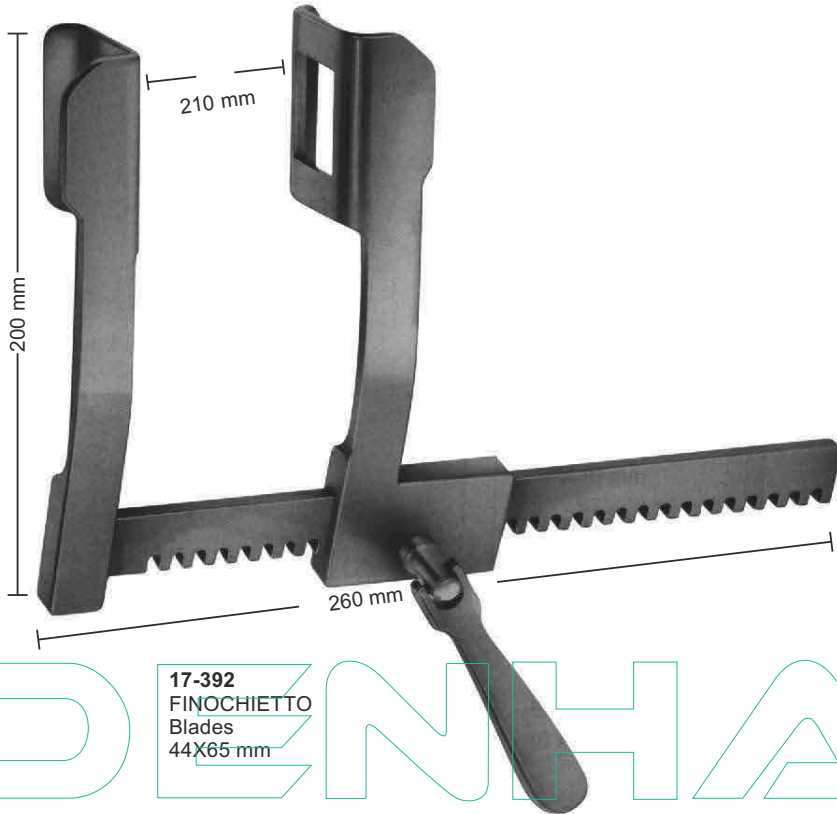

DENHART
INDUSTRY

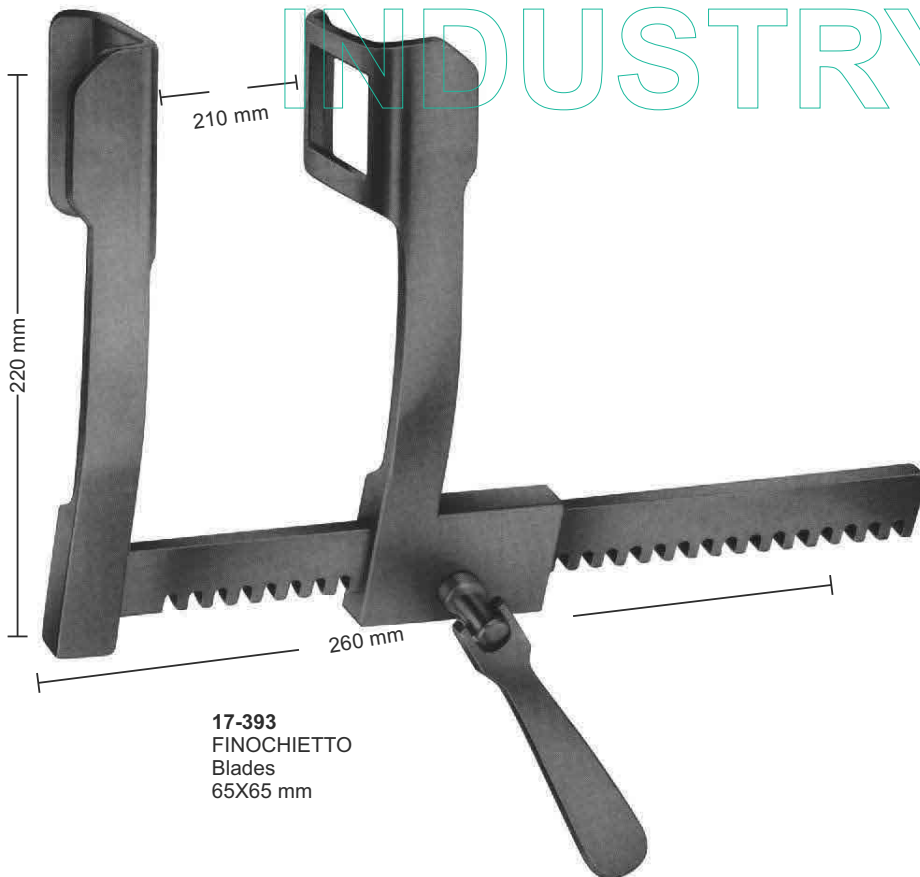

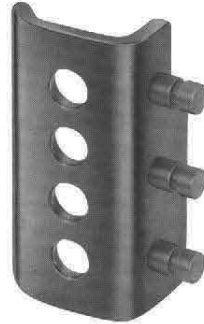

17-395
Blades
46x67 mm



17-396
Blades
80x67 mm



17-397
Blades
46x67 mm

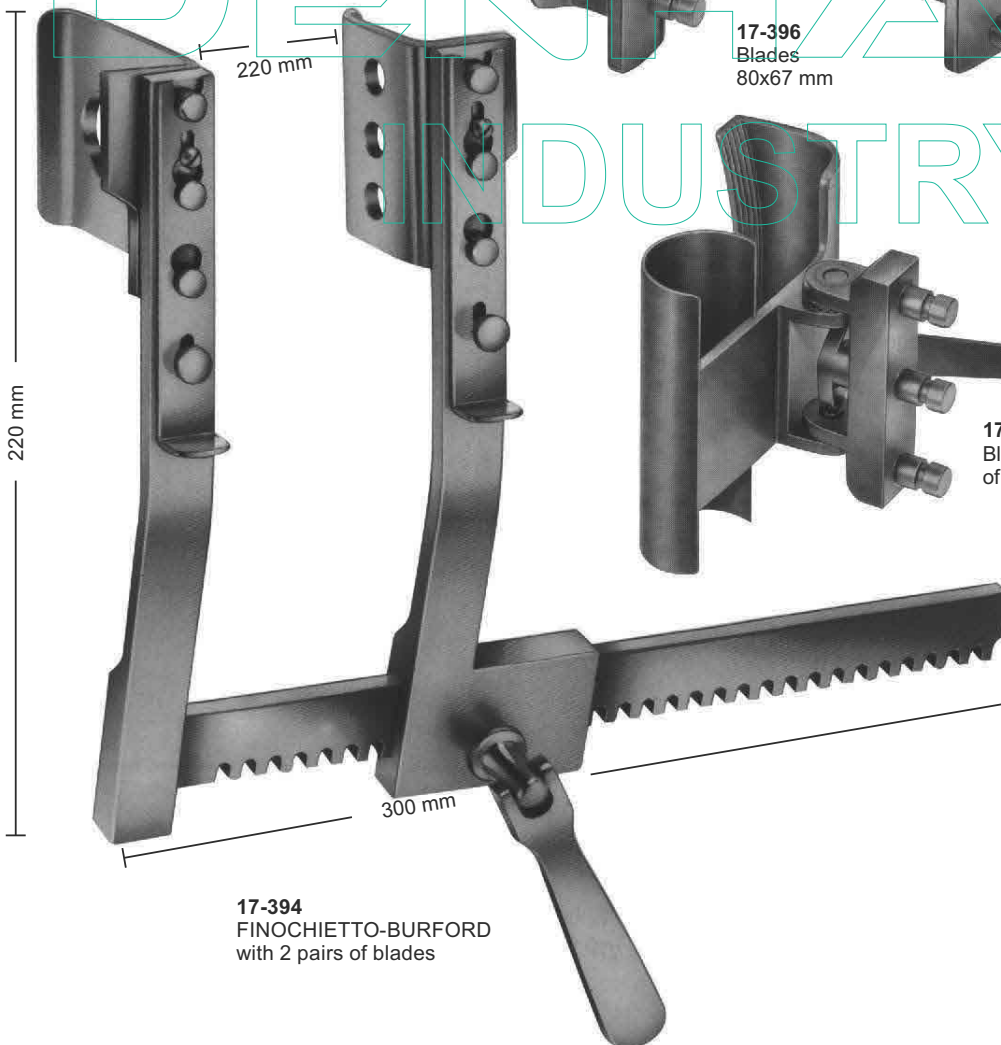
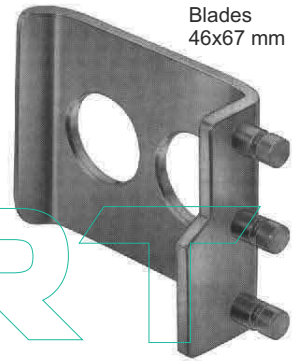
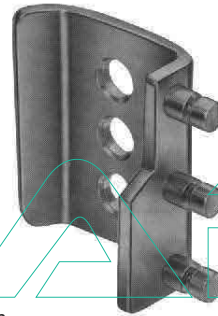
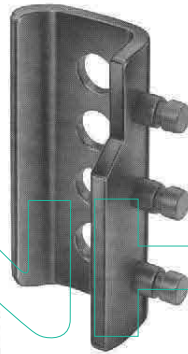

17-394
FINOCHIETTO-BURFORD
with 2 pairs of blades

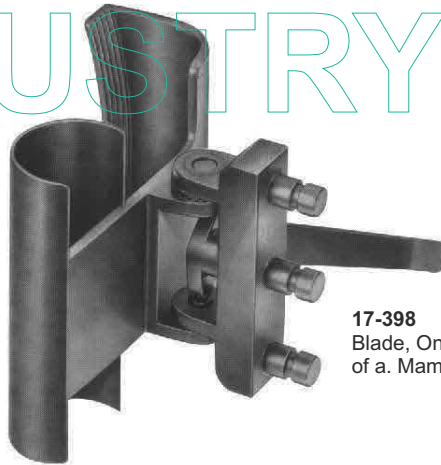

17-398
Blade, Only, for preparation
of a. Mammaria, 25.5x80mm

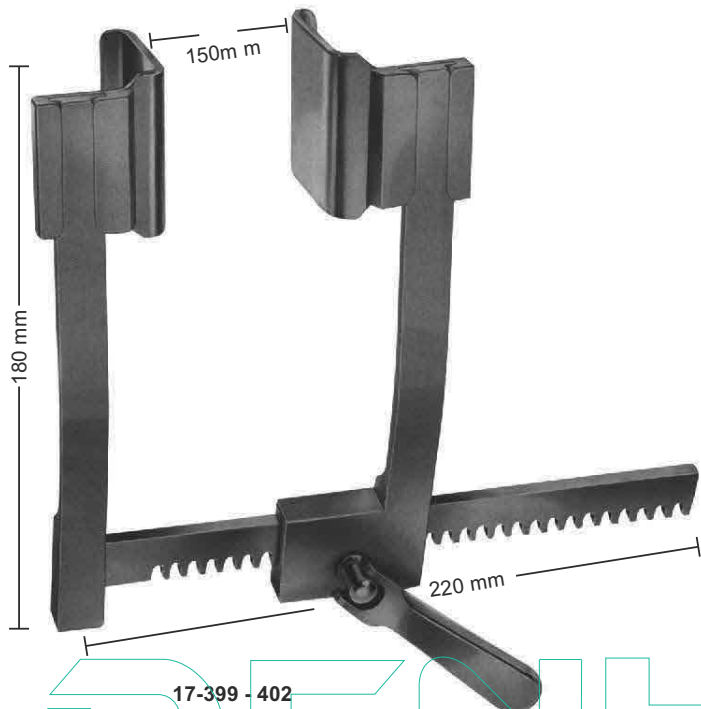

17-399 - 402
DE-BAKEY
with 3 pairs of blades

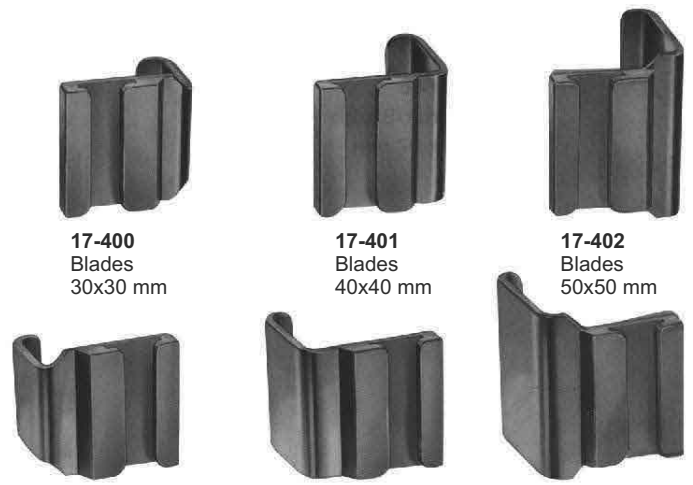

17-400
Blades
30x30 mm

17-401
Blades
40x40 mm

17-402
Blades
50x50 mm

DENHART
INDUSTRY

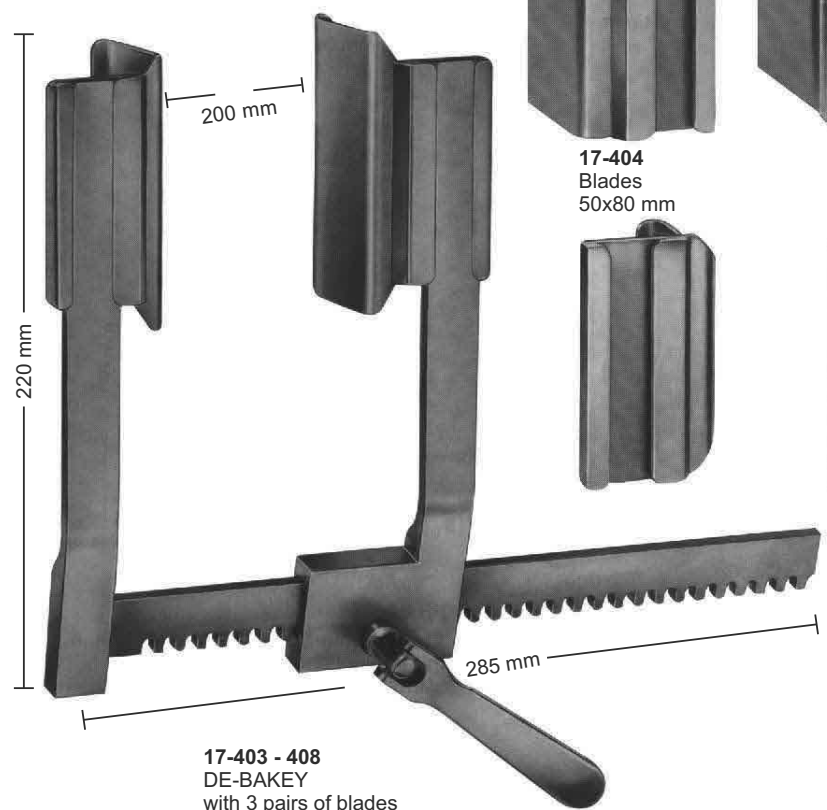

17-403 - 408
DE-BAKEY
with 3 pairs of blades

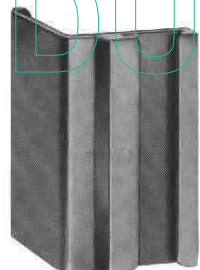

17-404
Blades
50x80 mm

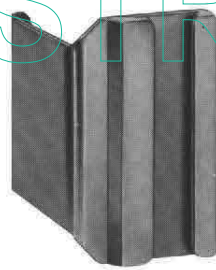

17-405
Blades
80x60 mm

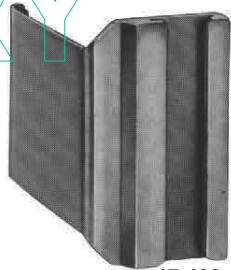

17-406
Blades
50x80 mm

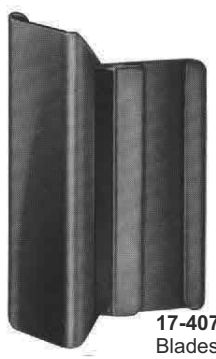

17-407
Blades
40x100 mm

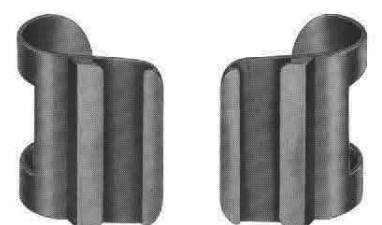
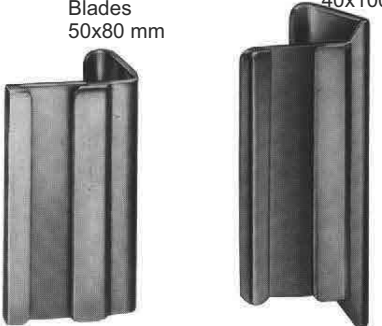

17-408
Sternotomy Blades
50x660 mm

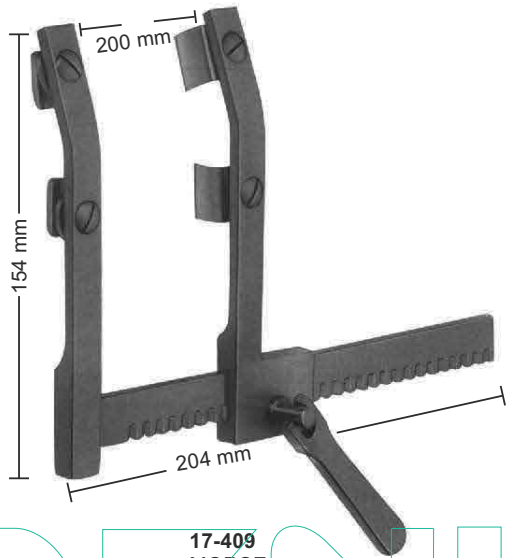

17-409
MORSE
Sternotomy spreader
for children, with moveable
double, each blade
12x20 mm

DENHART
INDUSTRY

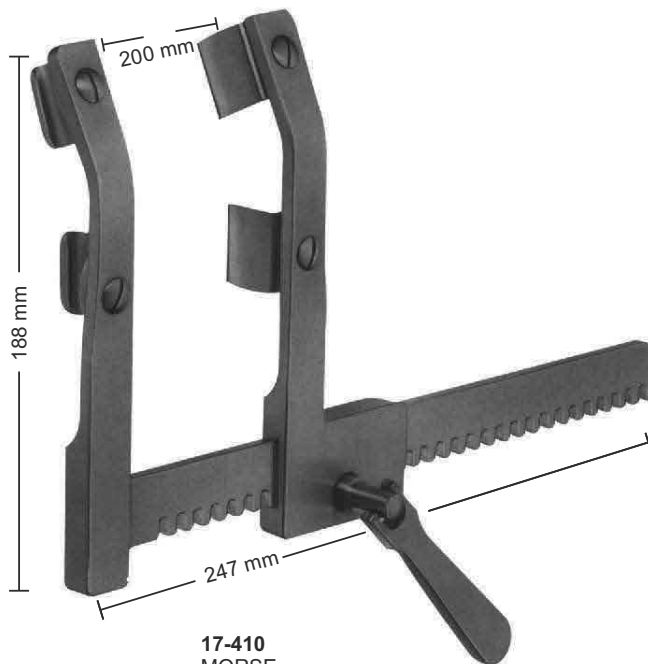

17-410
MORSE
Sternotomy spreader
for adults, with moveable
double, each blade
19x19 mm

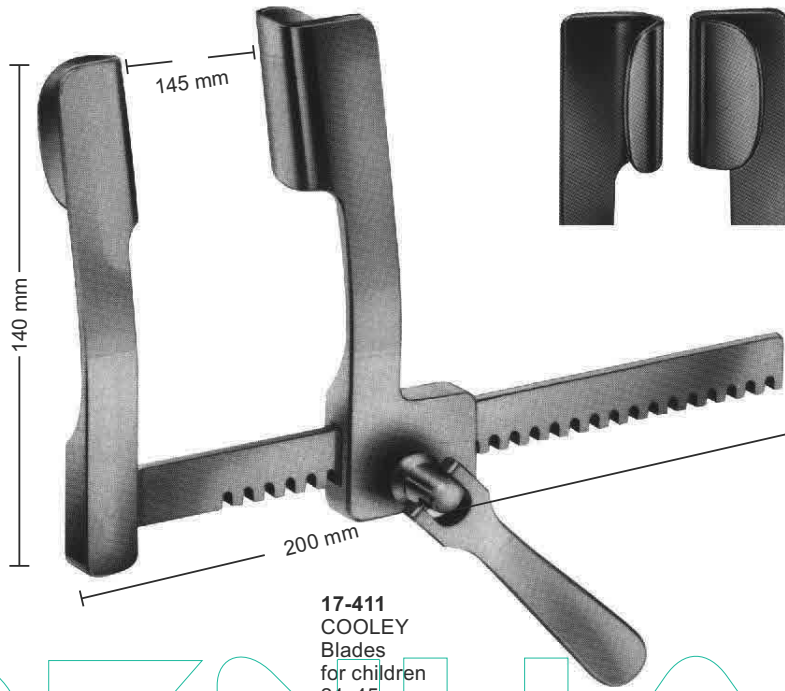

DENHART
INDUSTRY

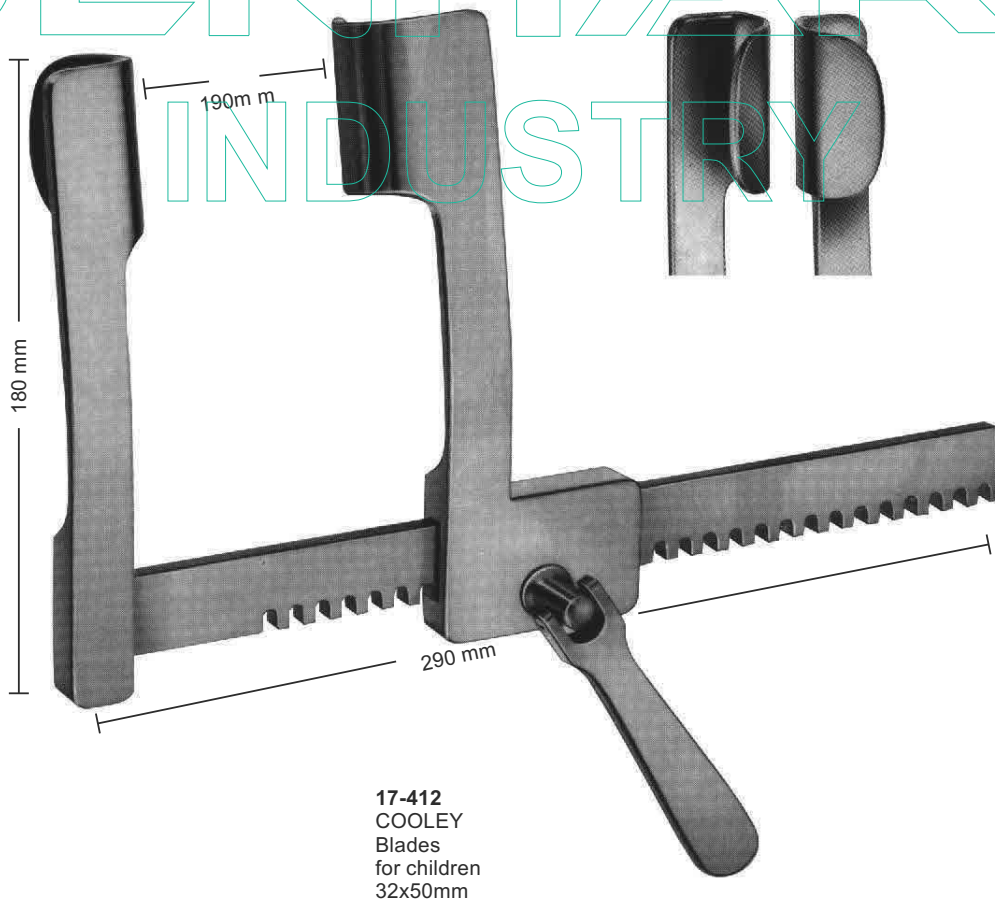



17-414
Blades
75x75 mm



17-415
Blades
42x65 mm

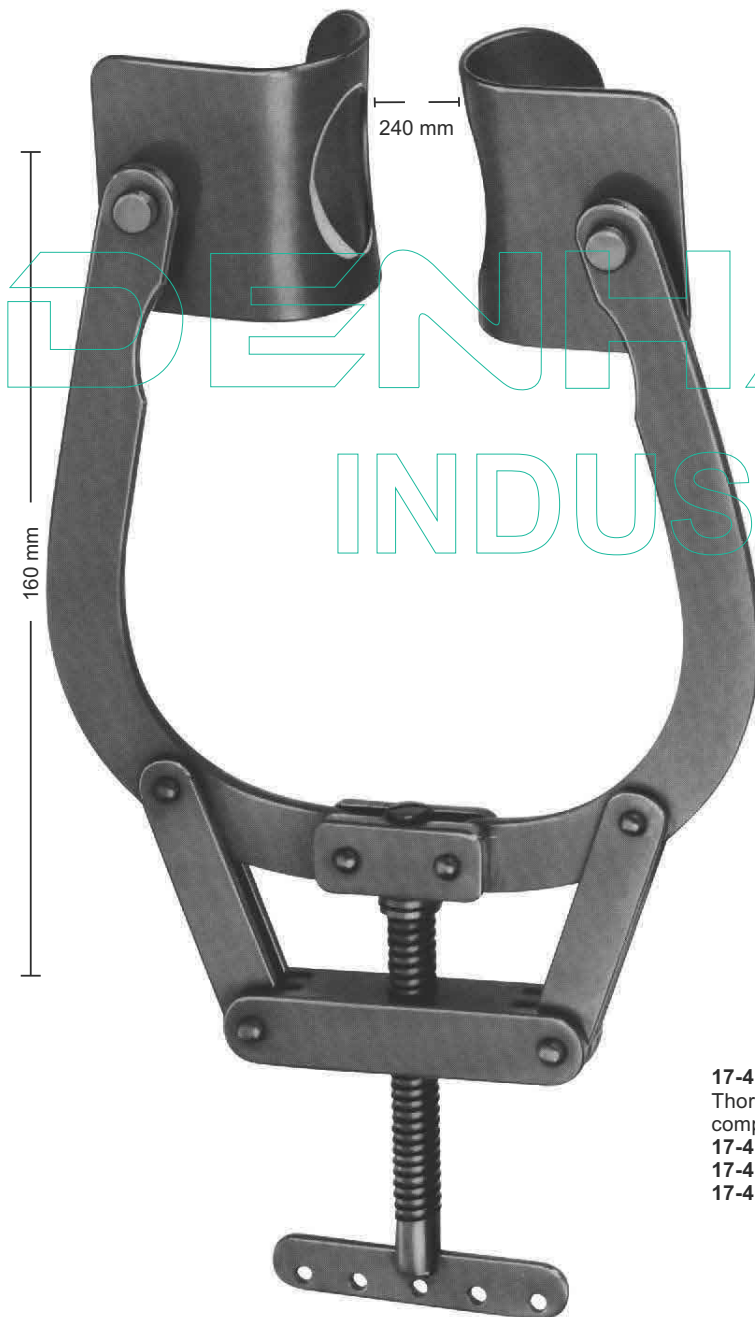

Blades with Ball Snap System
Delivery: in Pairs

- 17-413 - 415**
Thoraxsperrer (Mercedes-Sperrer)
complete consisting of:
17-413 Retractor only
17-414 1 Pair of blades 42x65 mm
17-415 1 Pair of blades 75x75 mm

DENHART INDUSTRY



17-416
SELLORS
Rib spreader-and contractor
with swivel blades
200 mm



17-417
BAILEY
150 mm



17-418
for children

17-419
for children

17-418 - 419
BAILEY
200 mm

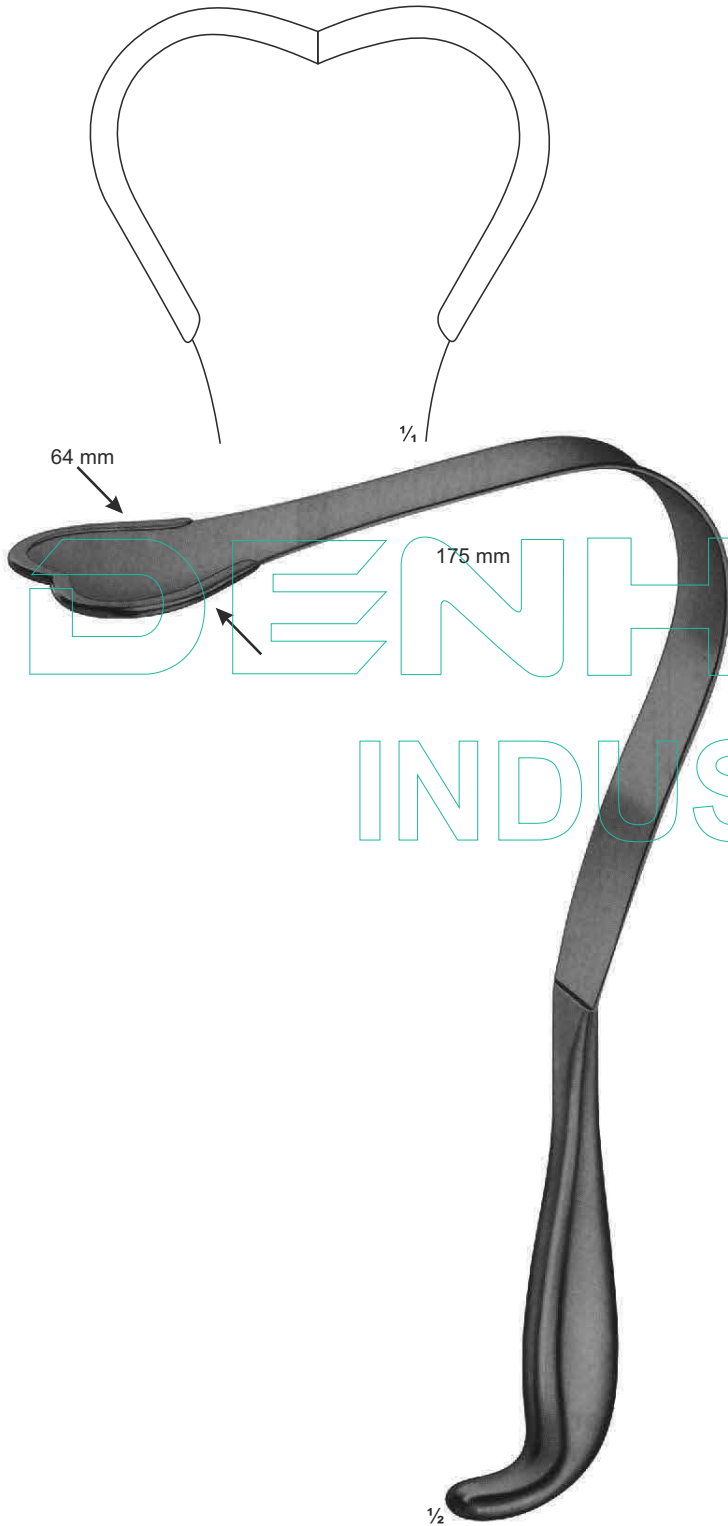

17-420
HARRINGTON-PEMBERTON
federnd/flexible
295 mm

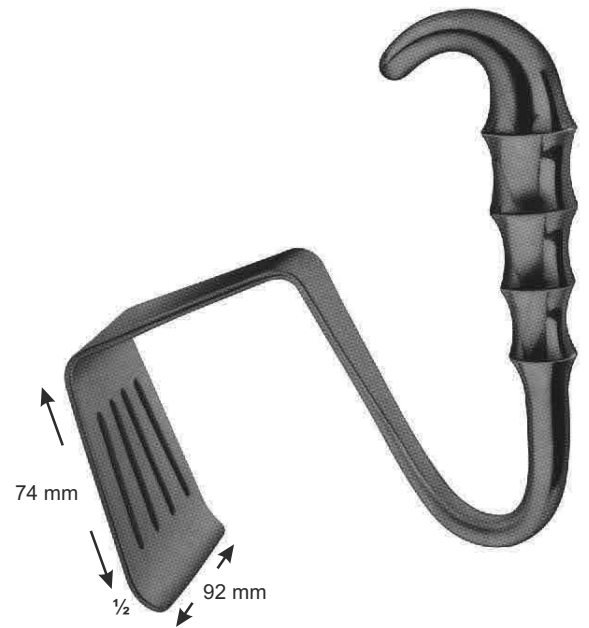

17-421
DAVIDSON
Scalpel haken

DENHART
INDUSTRY

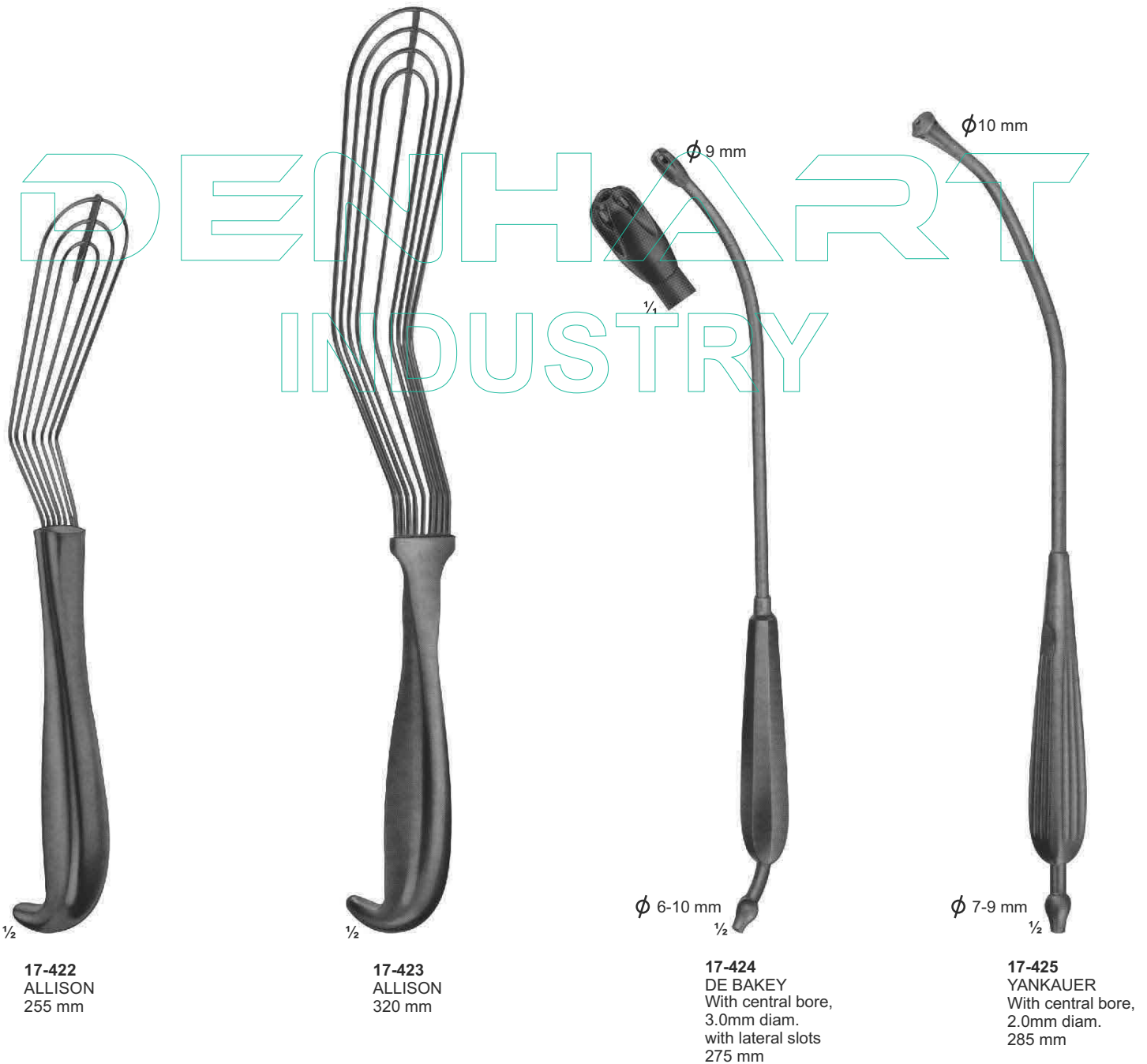

17-422
ALLISON
255 mm

17-423
ALLISON
320 mm

17-424
DE BAKEY
With central bore,
3.0mm diam.
with lateral slots
275 mm

17-425
YANKAUER
With central bore,
2.0mm diam.
285 mm

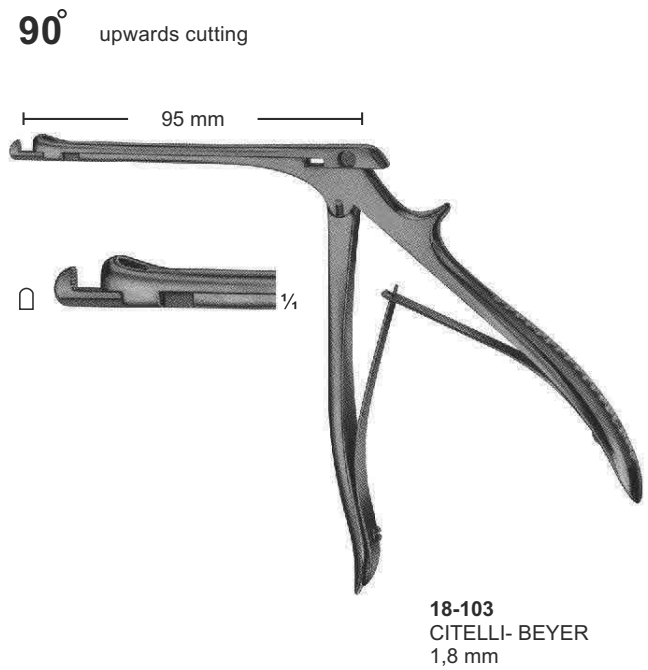
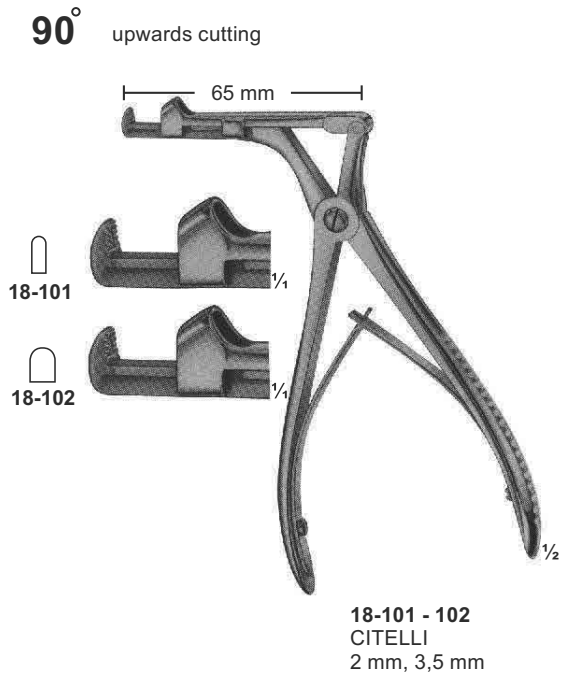
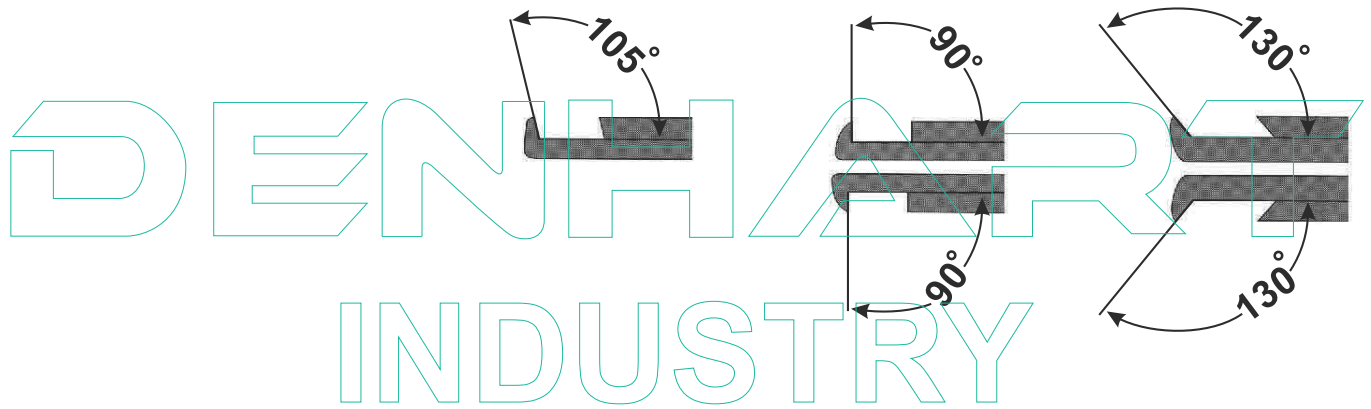

90° upwards cutting

85 mm

18-104
4 mm



1/4

18-105
5 mm



1/4



1/2

18-104 - 105
KERRISON

DENHART
INDUSTRY

90° upwards cutting

140 mm

18-106
3,3 mm



1/4

18-107
4,0 mm

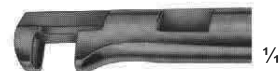

1/4

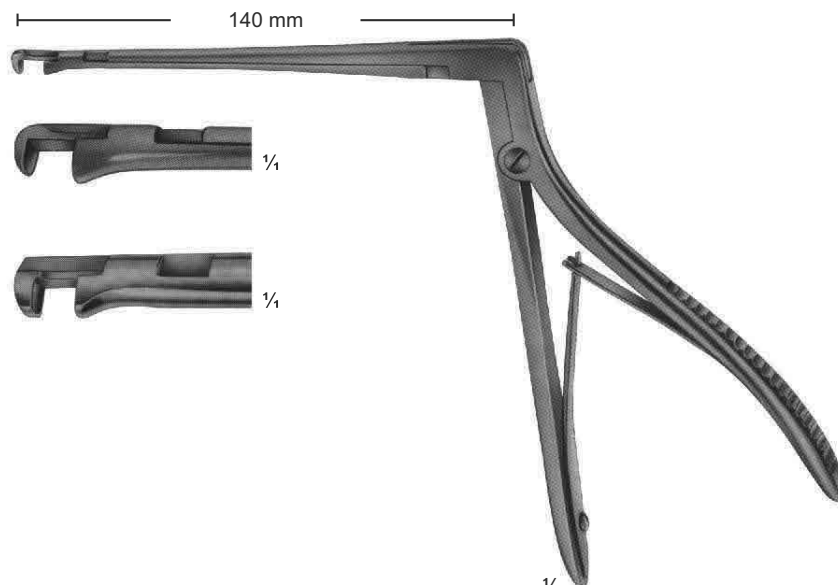

1/2

18-106 - 107
HAJEK-KOFLER

130° upwards cutting

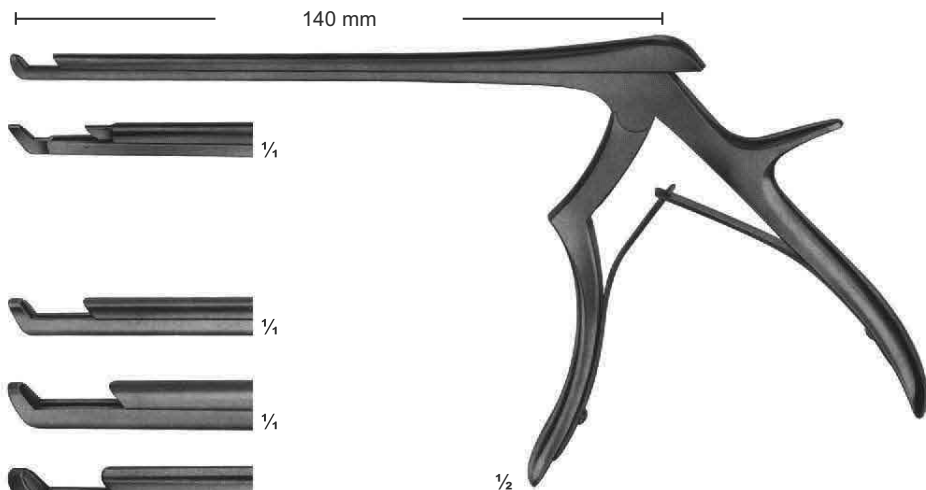

18-108
1 mm



18-109
2 mm



18-110
3 mm



18-111
4 mm



18-112
5 mm



18-108 - 112
KERRISON-JACOBY

INDUSTRY

90° upwards cutting

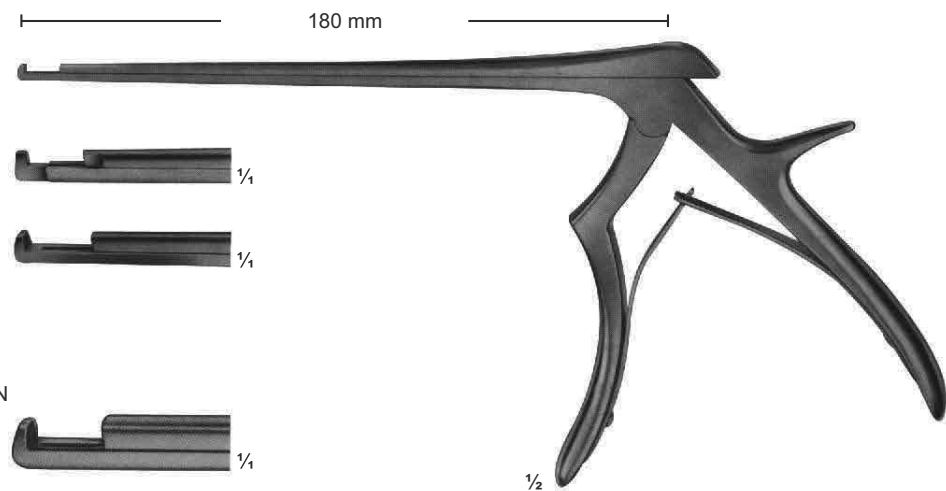

18-113
1 mm



18-114
2 mm



FERRIS-SMITH-KERRISON

18-115
3 mm



18-116
4 mm



18-117
5 mm



18-113 - 117
KERRISON-JACOBY

Angled positions for rongeurs

- 18-118**
3,0 mm
- 18-119**
3,6 mm
- 18-120**
4,2 mm
- 18-121**
4,8 mm
- 18-122**
5,8 mm

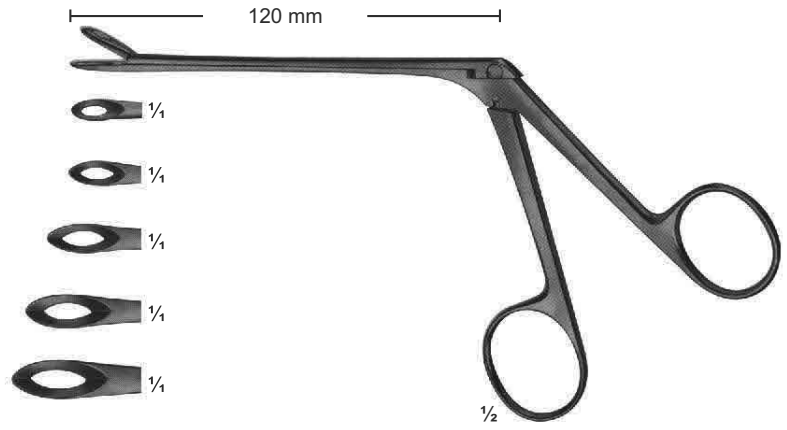

18-118 - 122
WEIL-BLAKESLEY

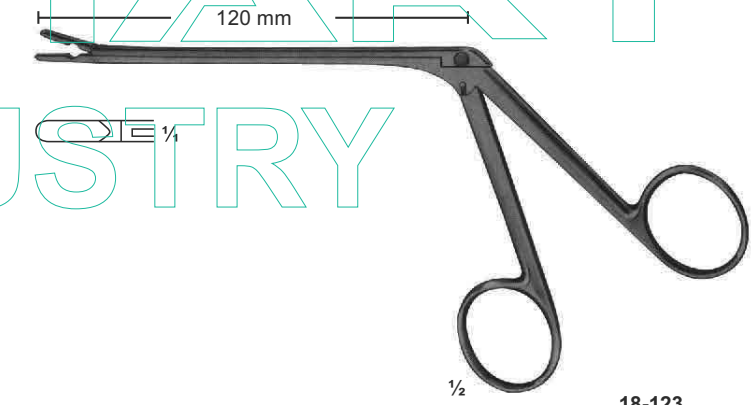
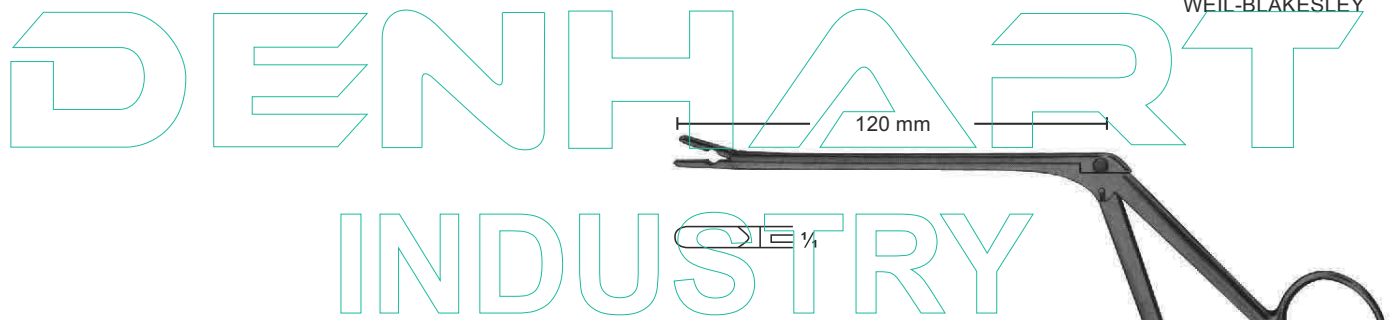

18-123
TAKAHASHI
3 mm

130°

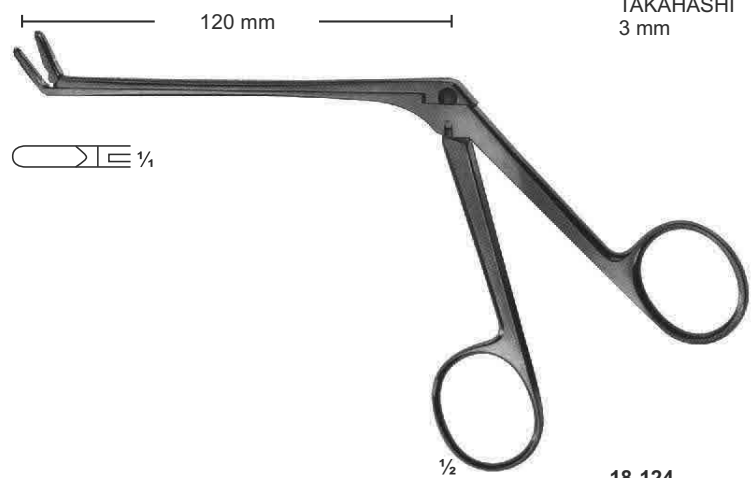

18-124
TAKAHASHI
3 mm

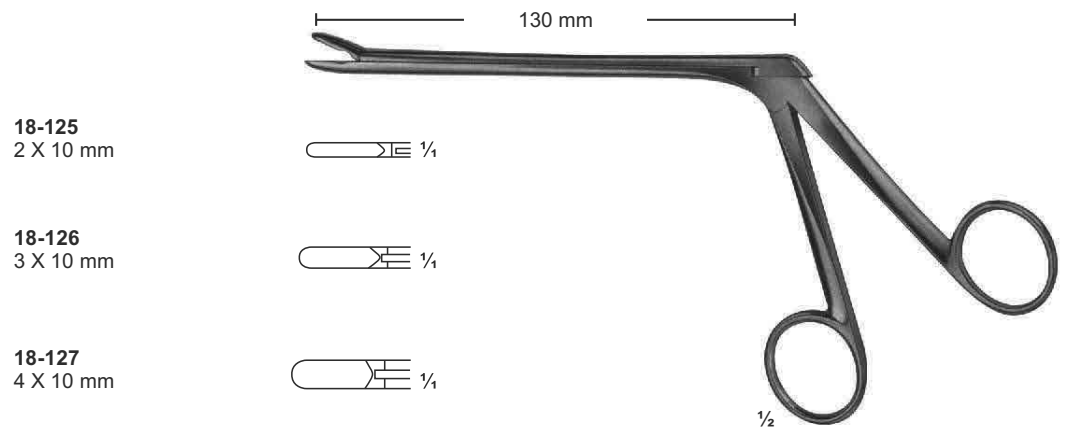

18-125 - 127
LOVE-GRUENWALD

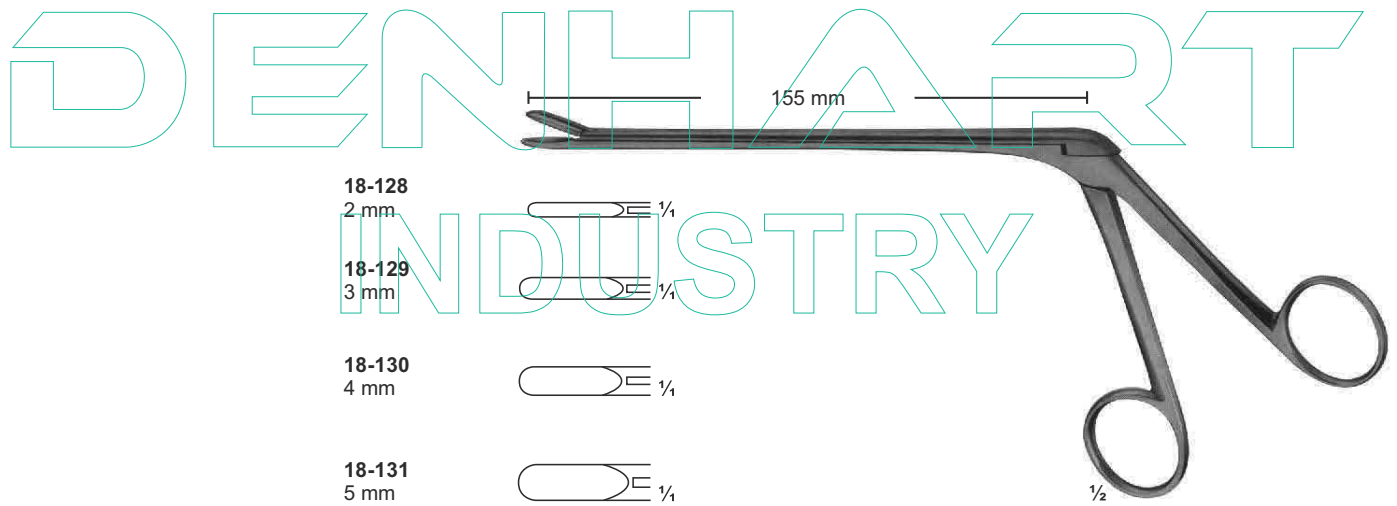

18-128 - 131
CASPAR

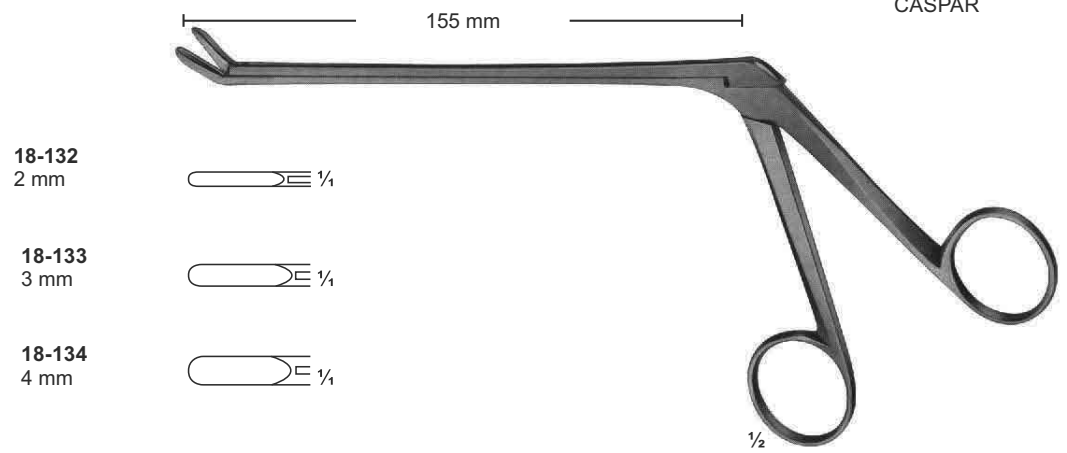

18-132 - 134
CASPAR

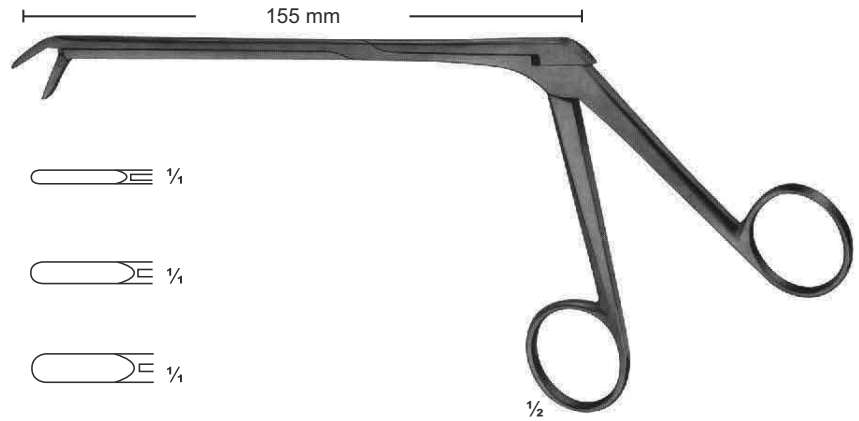

18-135
2 mm

18-136
3 mm

18-137
4 mm

18-135 - 137
CASPAR

DENHART

Length of shaft 140 mm	Length of shaft 160 mm	Length of shaft 185 mm	size of jaws	
18-138	18-143	18-148	2 X12 mm	1/4
18-139	18-144	18-149	3 X12 mm	1/4
18-140	18-145	18-150	4 X14 mm	1/4
18-141	18-146	18-151	5 X14 mm	1/4
18-142	18-147	18-152	6 X16 mm	1/4

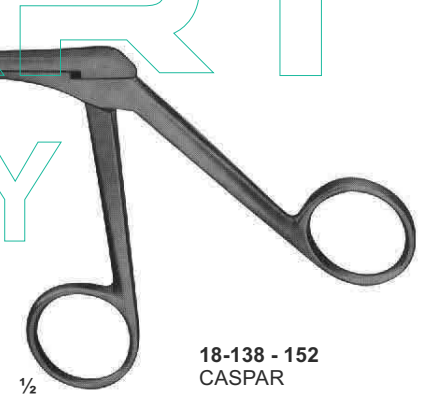

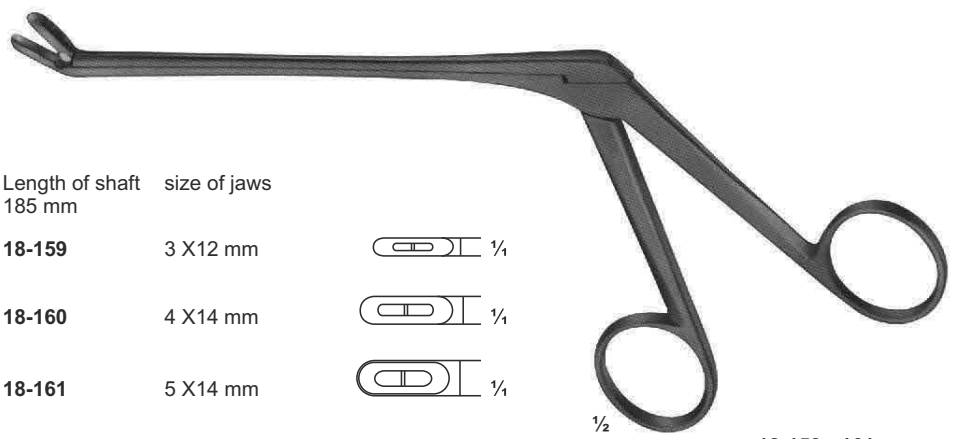

18-138 - 152
CASPAR

Length of shaft 140 mm	Length of shaft 160 mm	Length of shaft 185 mm	size of jaws	
18-153	18-156	18-159	3 X12 mm	1/4
18-154	18-157	18-160	4 X14 mm	1/4
18-155	18-158	18-161	5 X14 mm	1/4



18-153 - 161
CASPAR

Length of shaft 140 mm	Length of shaft 160 mm	Length of shaft 185 mm	size of jaws
18-162	18-164	185-166	3 X12 mm  ¼
18-163	18-165	18-167	4 X14 mm  ¼

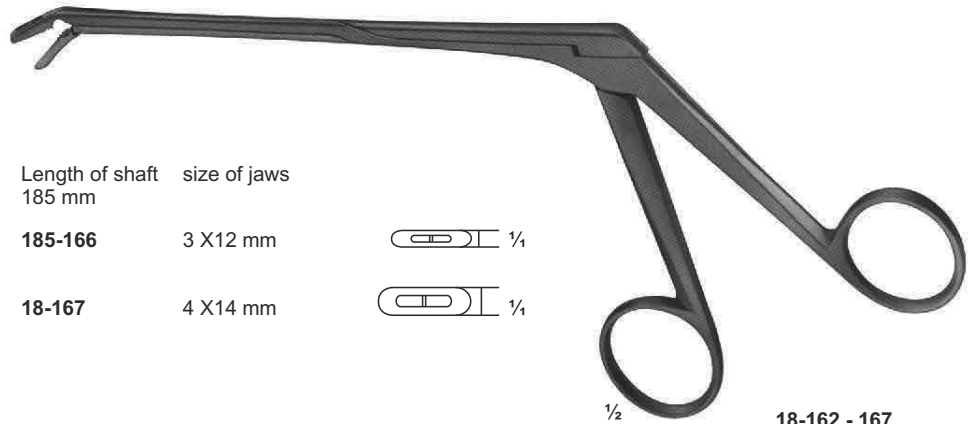

18-162 - 167
GUSHING

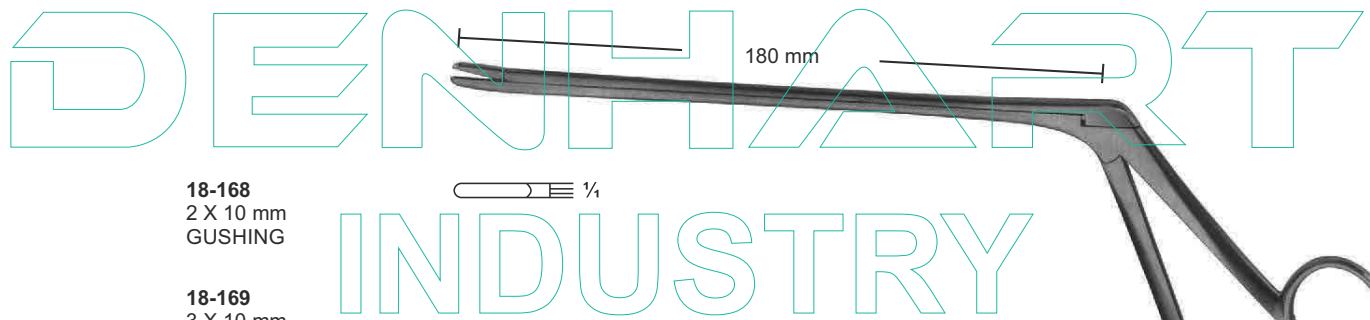

18-168
2 X 10 mm
GUSHING

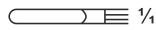

18-169
3 X 10 mm
LOVE-GRUENWALD

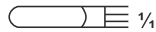

18-170
4 X 10 mm
SPURLING

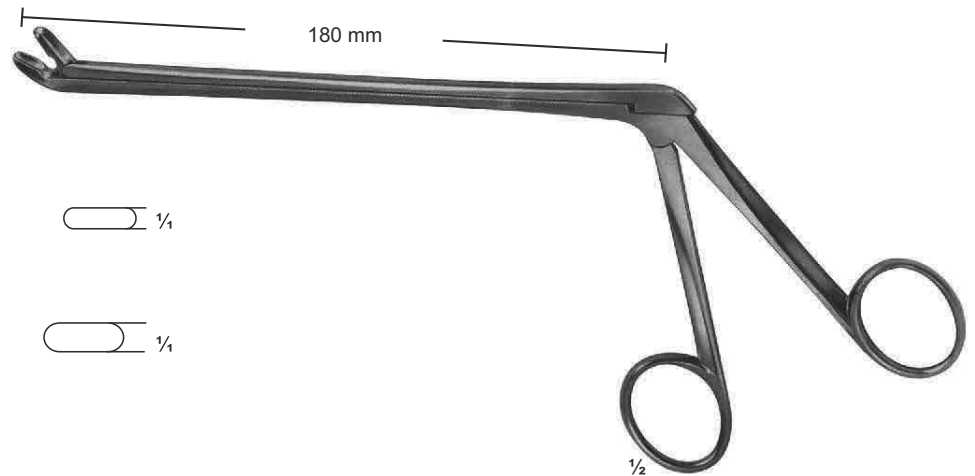
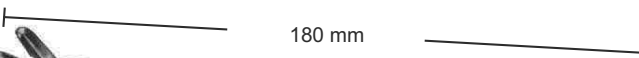
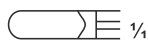

18-168 - 170
LOVE-GRUENWALD

18-171
3 X 10 mm
LOVE-GRUENWALD



18-172
4 X 10 mm
SPURLING



18-171 - 172
LOVE-GRUENWALD

18-173
3 X 10 mm
LOVE-GRUENWALD

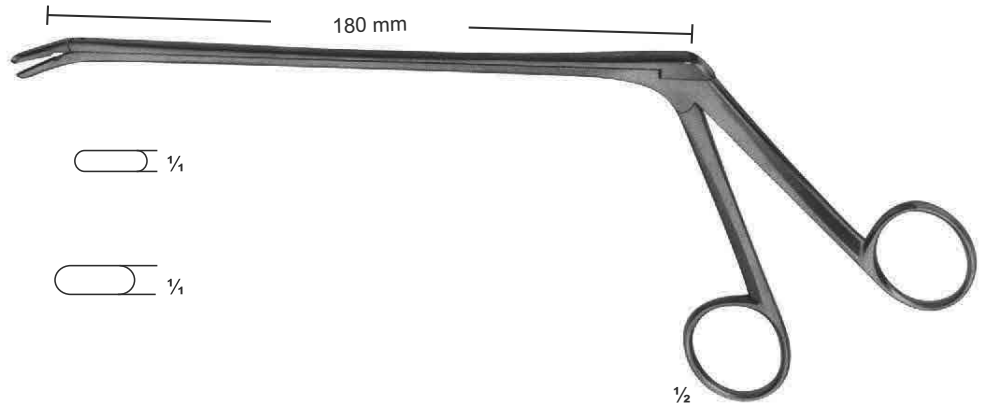

18-174
4 X 10 mm
SPURLING

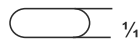

18-173 - 174
LOVE-GRUENWALD

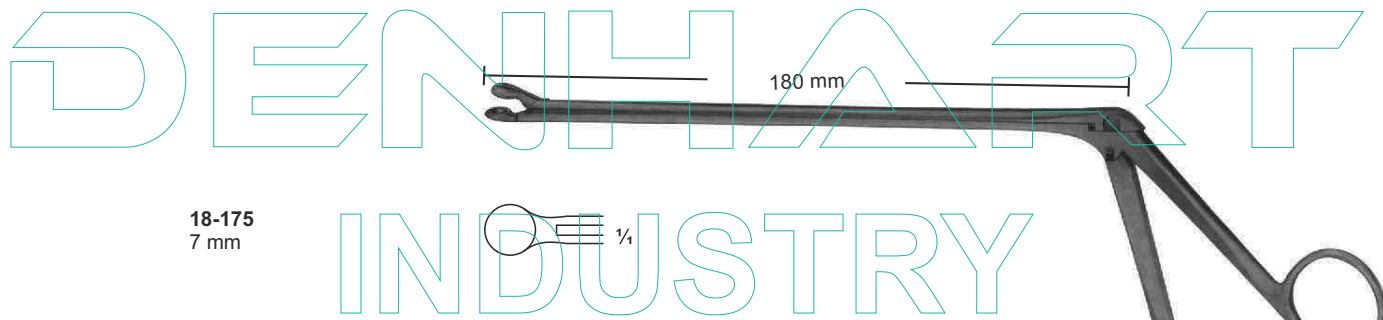

18-175
7 mm

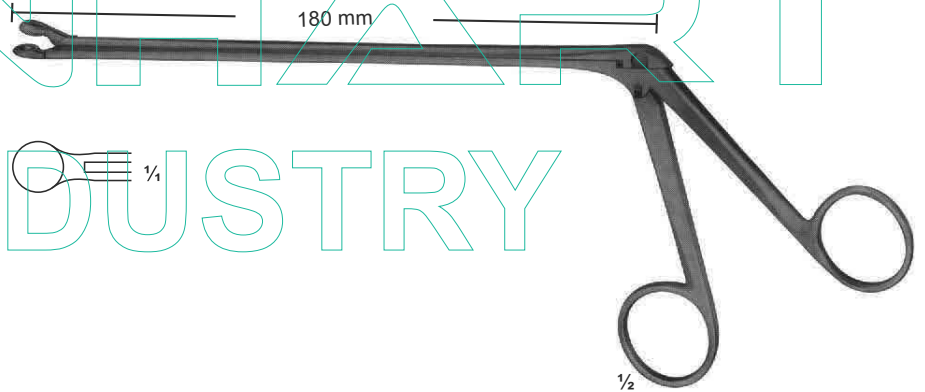

18-175
OLDBERG

18-176
YASARGIL
2,2 mm



18-177
YASARGIL
3,5 mm

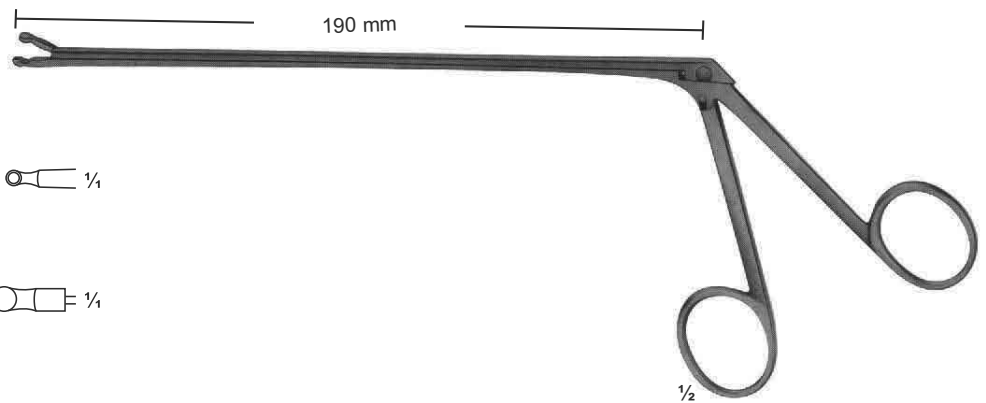

18-176 - 177

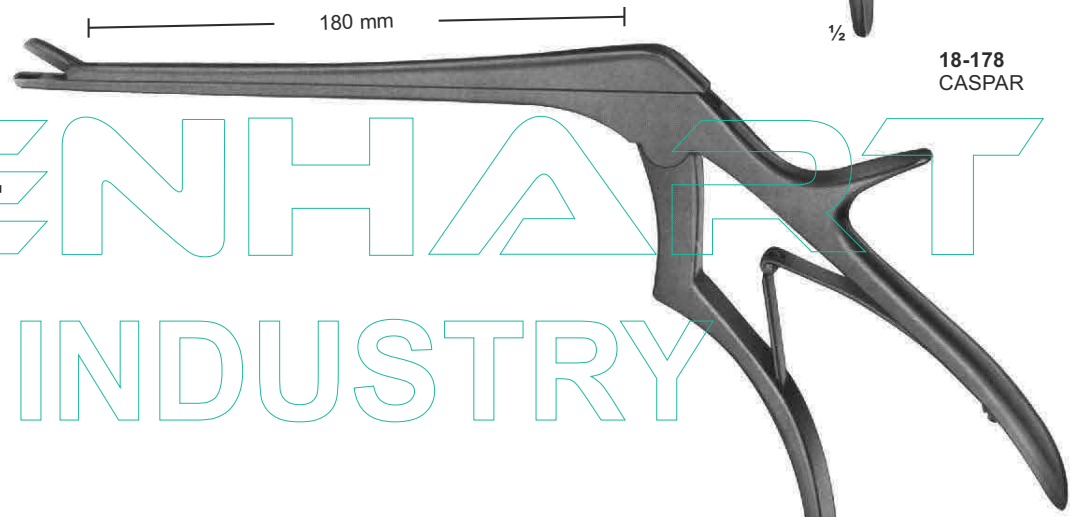
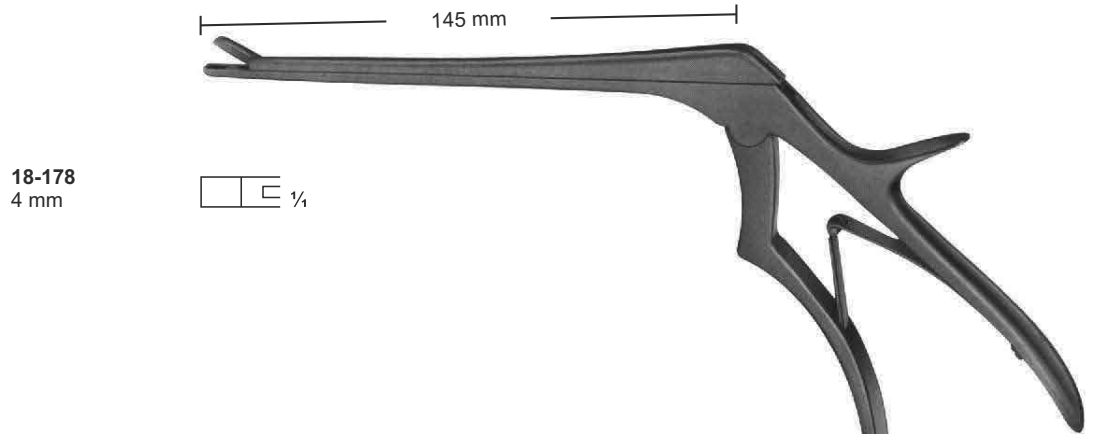

DENHART
INDUSTRY

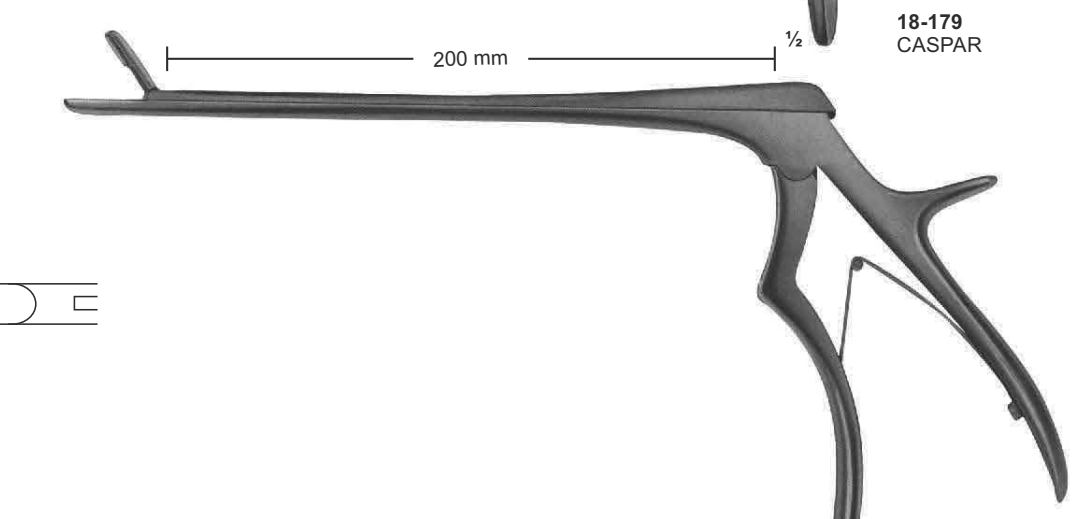



19-101
Comprimeter. Compression apparatus for producing exsanguination in the extremities. Manometer registers up to 600 mm Hg. Complete, consisting of:
19-101 2 Pump with manometer
19-102 3 Cuff for the leg
19-103 14 Cuff for the upper arm

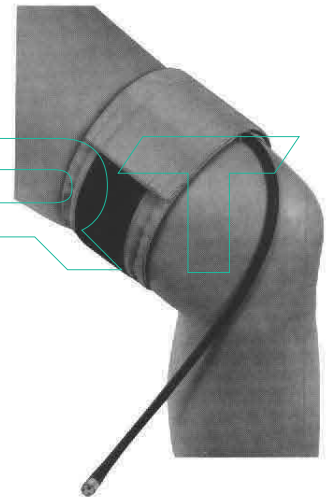
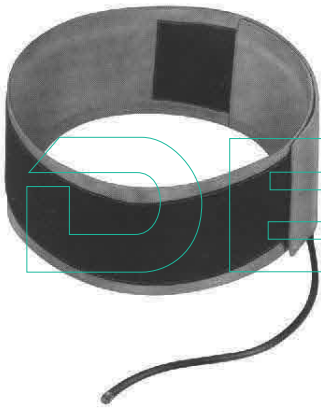

19-104 3 Cuff for the leg
19-105 4 Cuff for the lower arm
19-106 5 Cuff for children
19-107 14 Cuff for the upper arm

DENHART
INDUSTRY



19-108
ESMARCH
Staubbinde
Compression bandage
5 m lang/long
6 cm breit/wide



19-109
ESMARCH
Stauschlauch
Compression tube
1 m lang/long

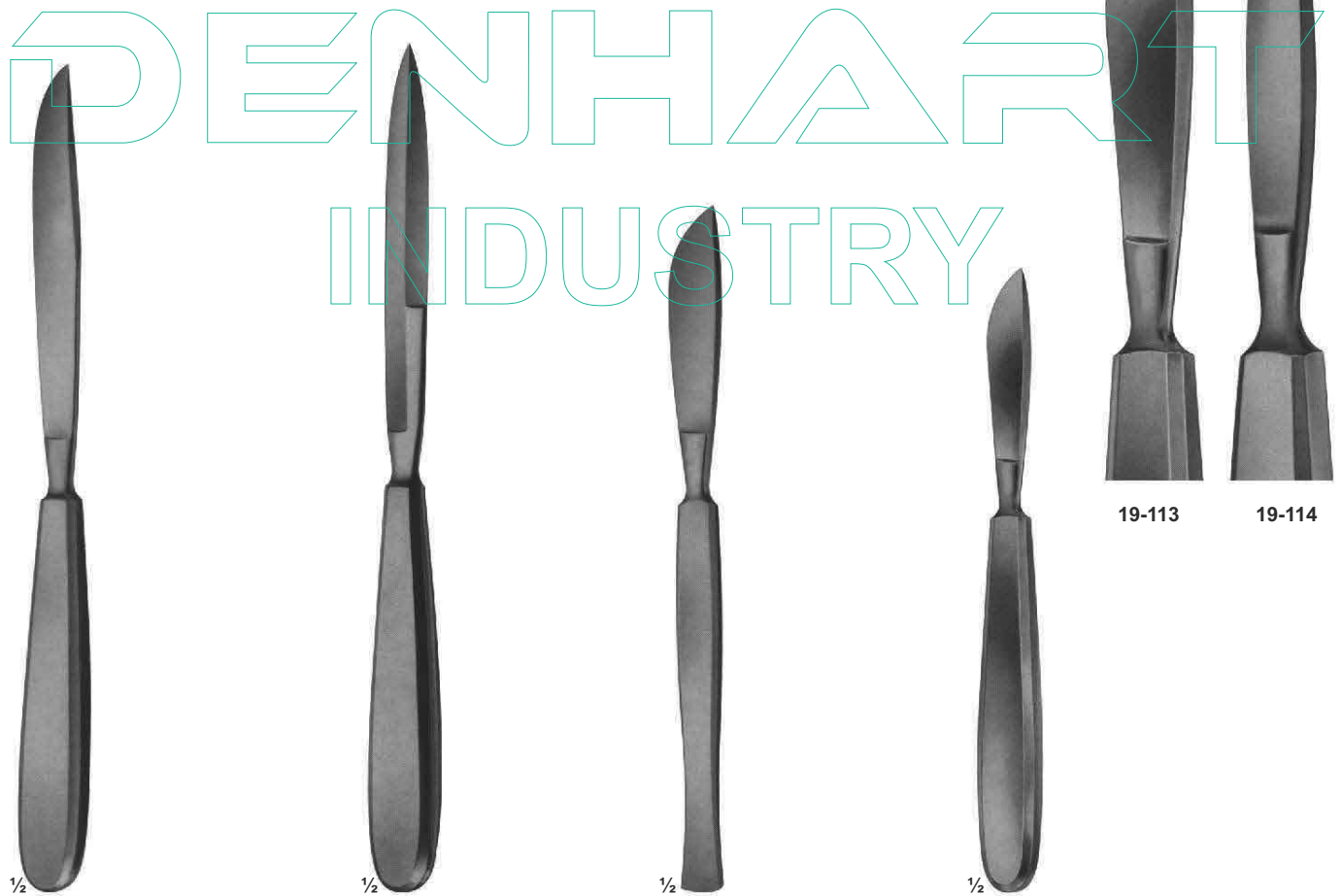

19-113

19-114

19-110
Length of blades
Phalangeal knife
105 mm

19-111
Length of blades
Interosseous knife
110 mm

19-112
Length of blades
Periosteum knife
with raspatory
65 mm

19-113 - 114
LANGENBECK
Length of blades
Resection knives
55 mm

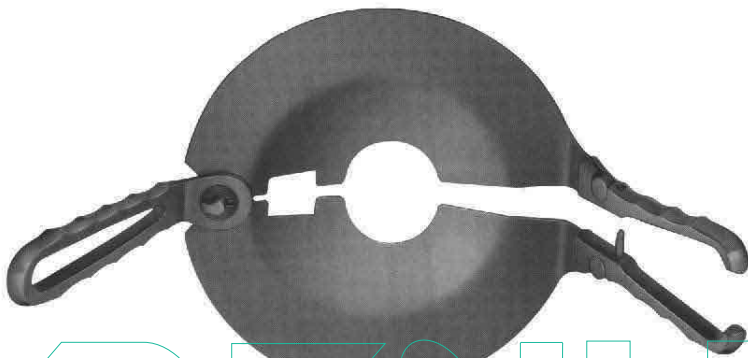

1/2

19-115
PERCY
removeable handles

DENHART
INDUSTRY

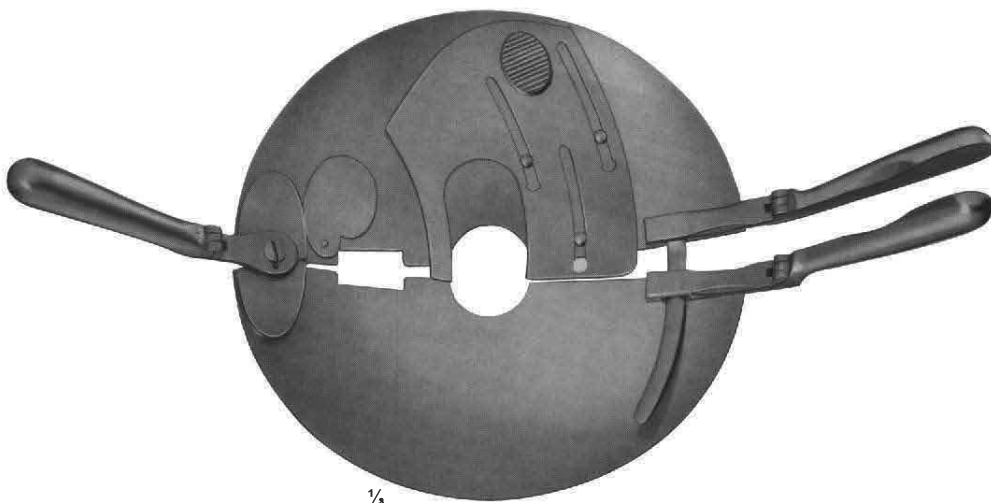

1/8

19-116
PERCY
reversible handles

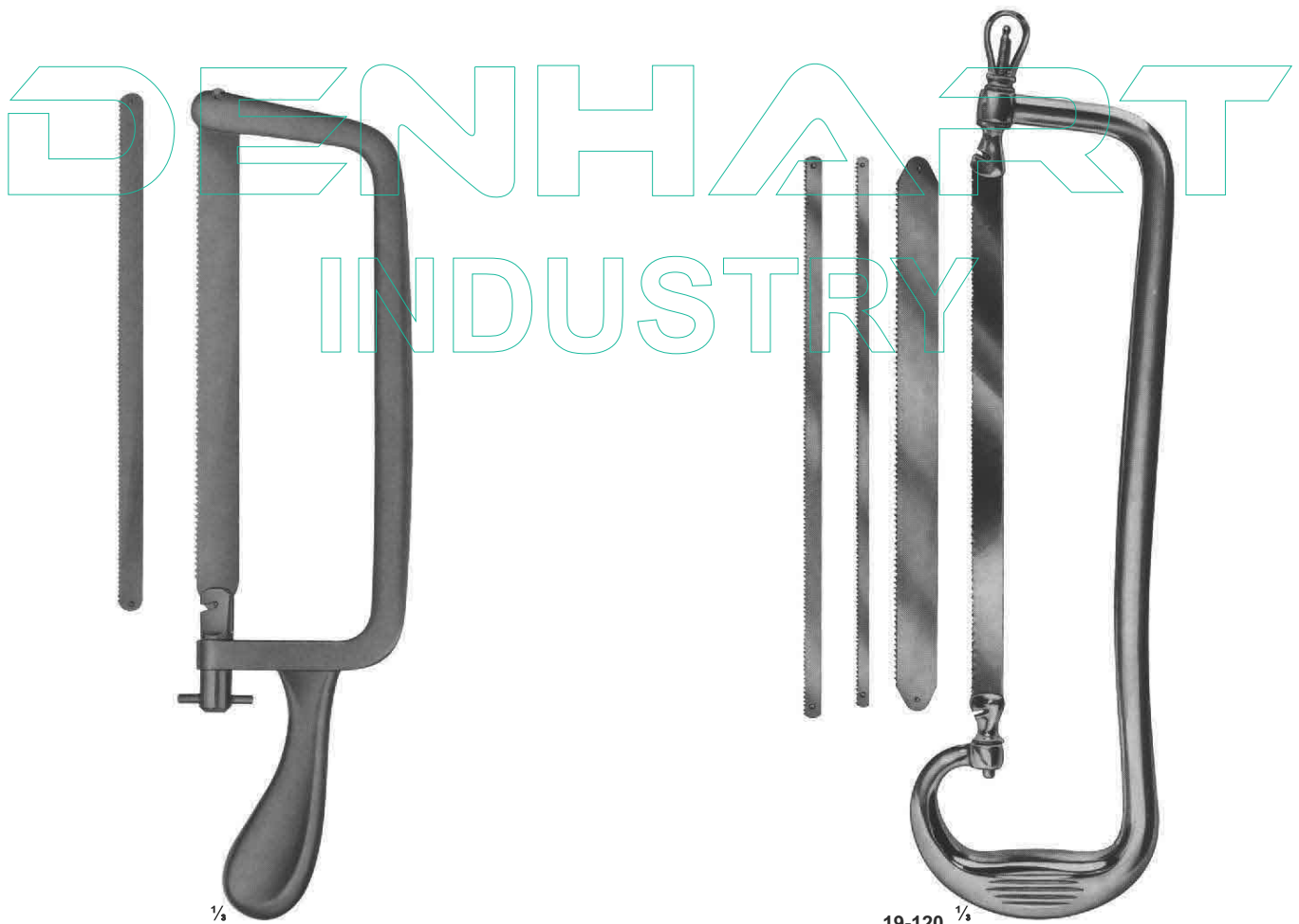

1/8
19-117
CHARRIEER
Length of blade
215 mm
complete with one saw
blade each
350 mm
Spare saw blades, carbon steel
19-118 12 mm
19-119 20 mm

1/8
19-120
RUST
Length of blade
235 mm
complete with one saw
blade each
390 mm
19-121 Bow only
Spare saw blades, carbon steel
19-122 6 mm
19-123 8 mm
19-124 12 mm
19-125 20 mm

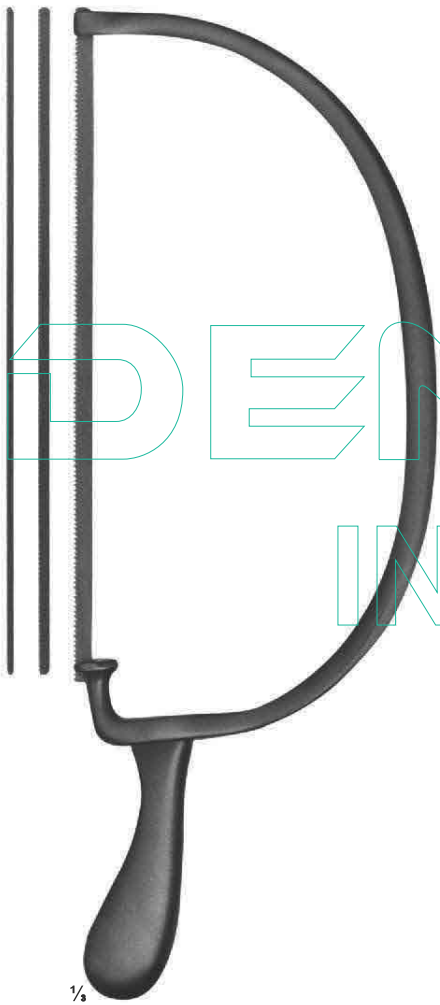

1/8

19-126
BIER
Length of blade
270 mm
complete with one saw
blade each
420 mm
Spare saw blades, carbon steel
19-127 4 mm
19-128 6 mm
19-129 8 mm

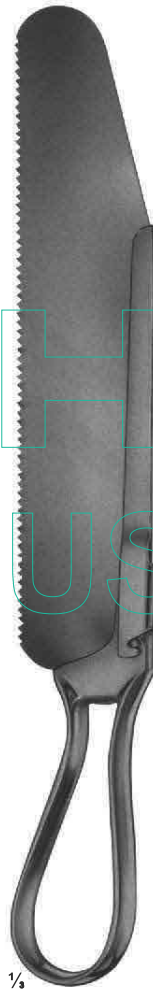

1/8

19-130
CHARRIERE
Length of blade
180 mm
Spare saw blades,
carbon steel
270 mm

19-131
CHARRIERE
Length of blade
240 mm
Spare saw blades,
carbon steel
340 mm



1/8

19-132
SATTERLEE
Length of blade
200 mm
Spare saw blades,
carbon steel
290 mm



1/8

19-133
LANGENBACK
Length of blade
115 mm
Metacarpal saw
235 mm

DENHART INDUSTRY

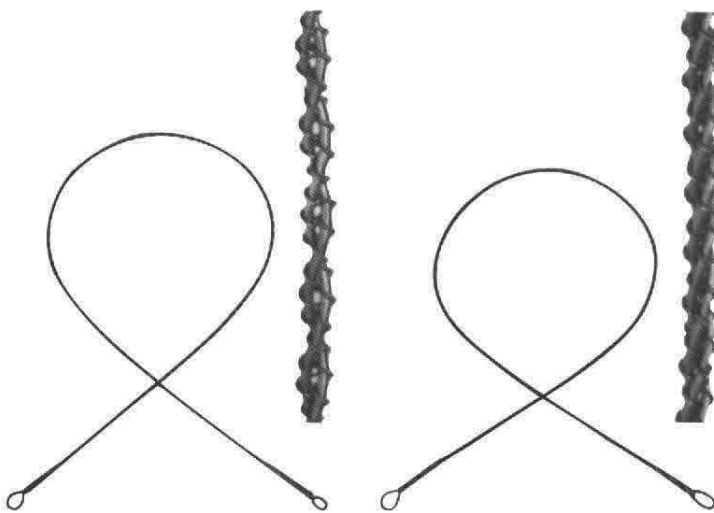

OLIVECRONA
19-134 300 mm
19-135 400 mm
19-136 500 mm
19-137 700 mm

GIGLI
19-138 300 mm
19-139 400 mm
19-140 500 mm
 fine, 6 wires twisted
19-141
 coares, 4 wires twisted



19-142
GIGLI
 Handle



19-143
LEBSCHKE
 Conductor for
 wire saws, malleable
 250 mm

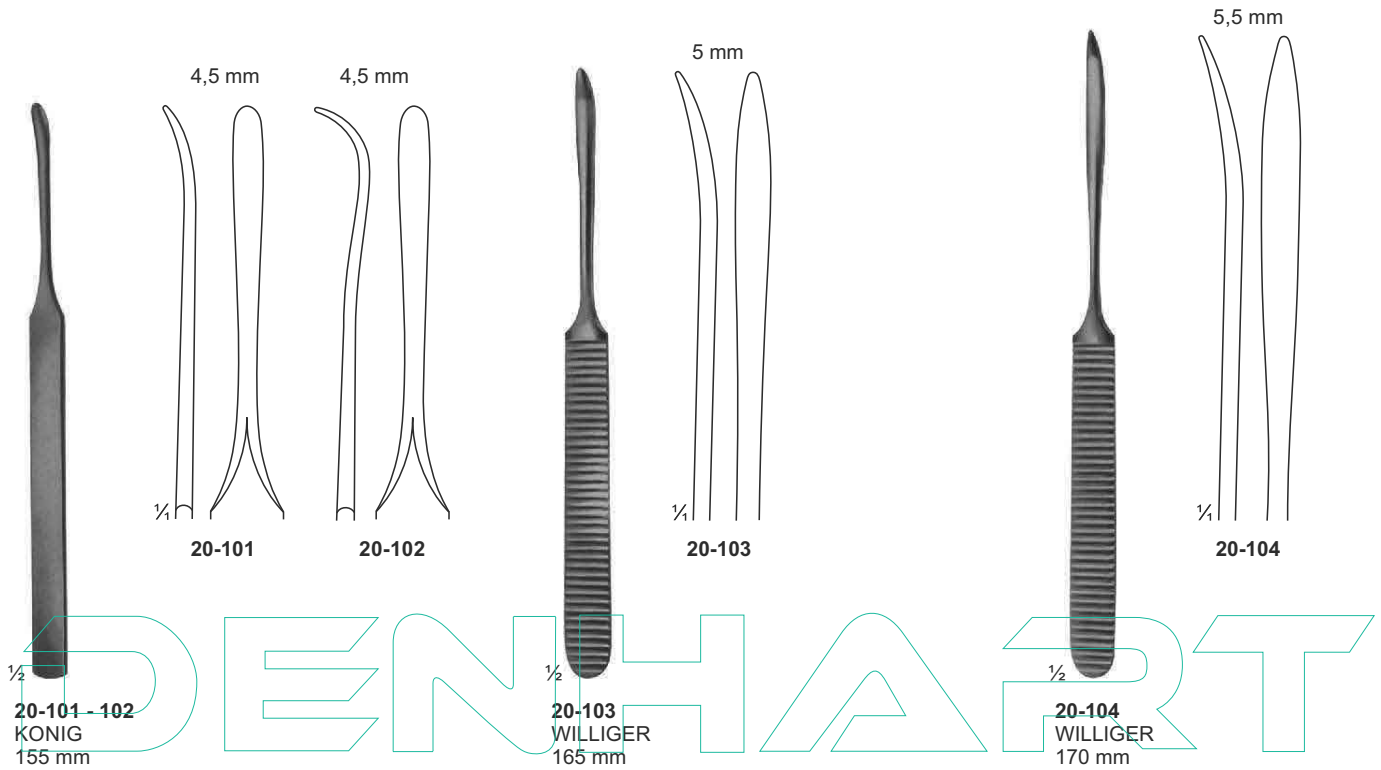

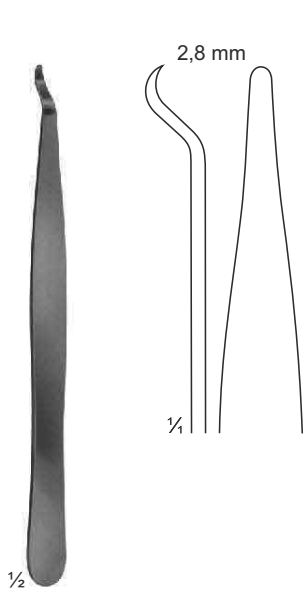

20-109
140mm

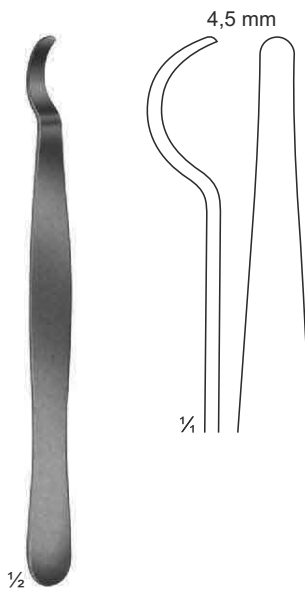

20-110
150mm

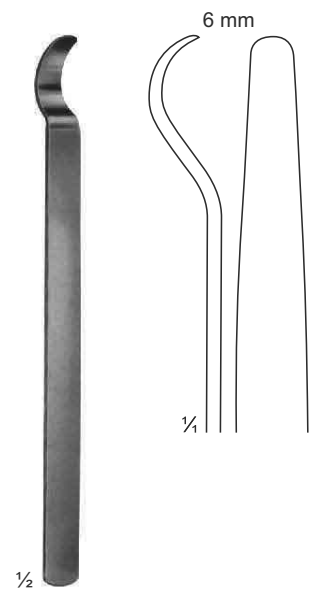

20-111
150mm

DENHART
INDUSTRY

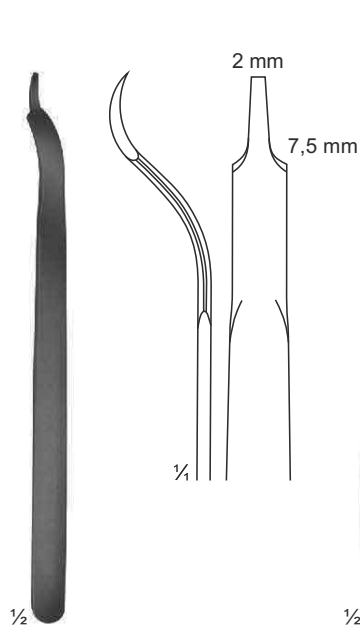

20-112
BUCK-GRAMCKO
150mm

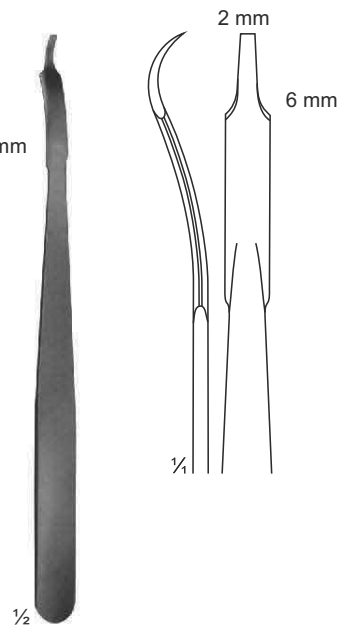

20-113
160mm

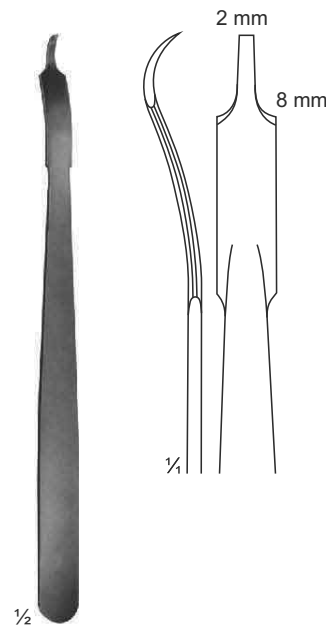

20-114
160mm

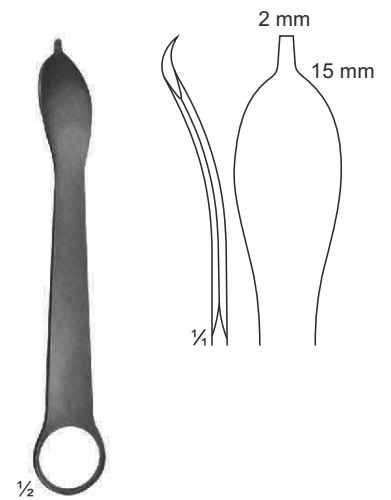

20-115
125mm



20-116
LANE TRETOWAN
215mm

20-117
LANE
255mm

20-118
LANGE-HOHMANN
250mm

20-119 - 120
LANGE-HOHMANN
20-119 265mm
20-120 280mm

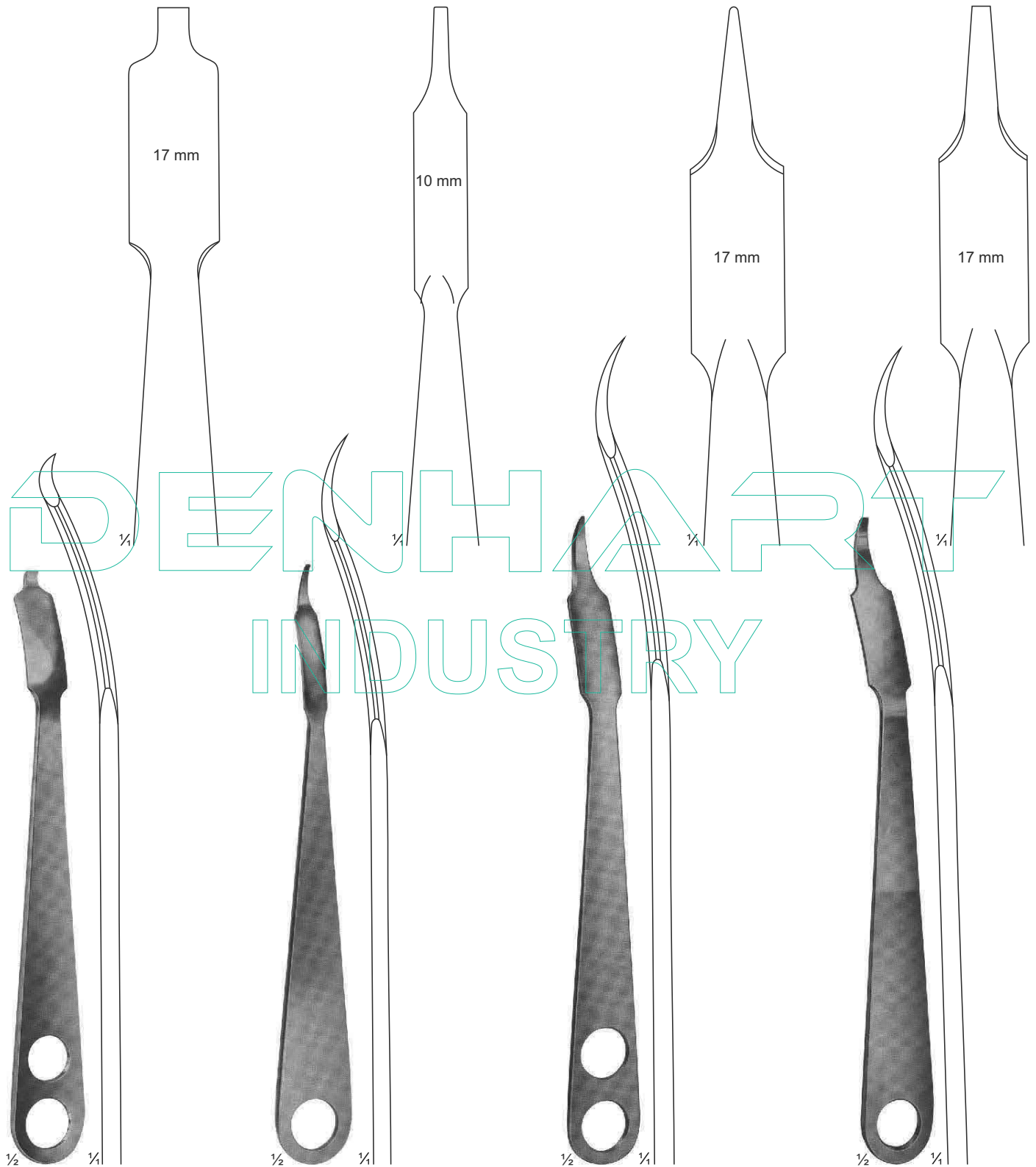

20-121
WAGNER
220 mm

20-122
220 mm

20-123
240 mm

20-124
240 mm

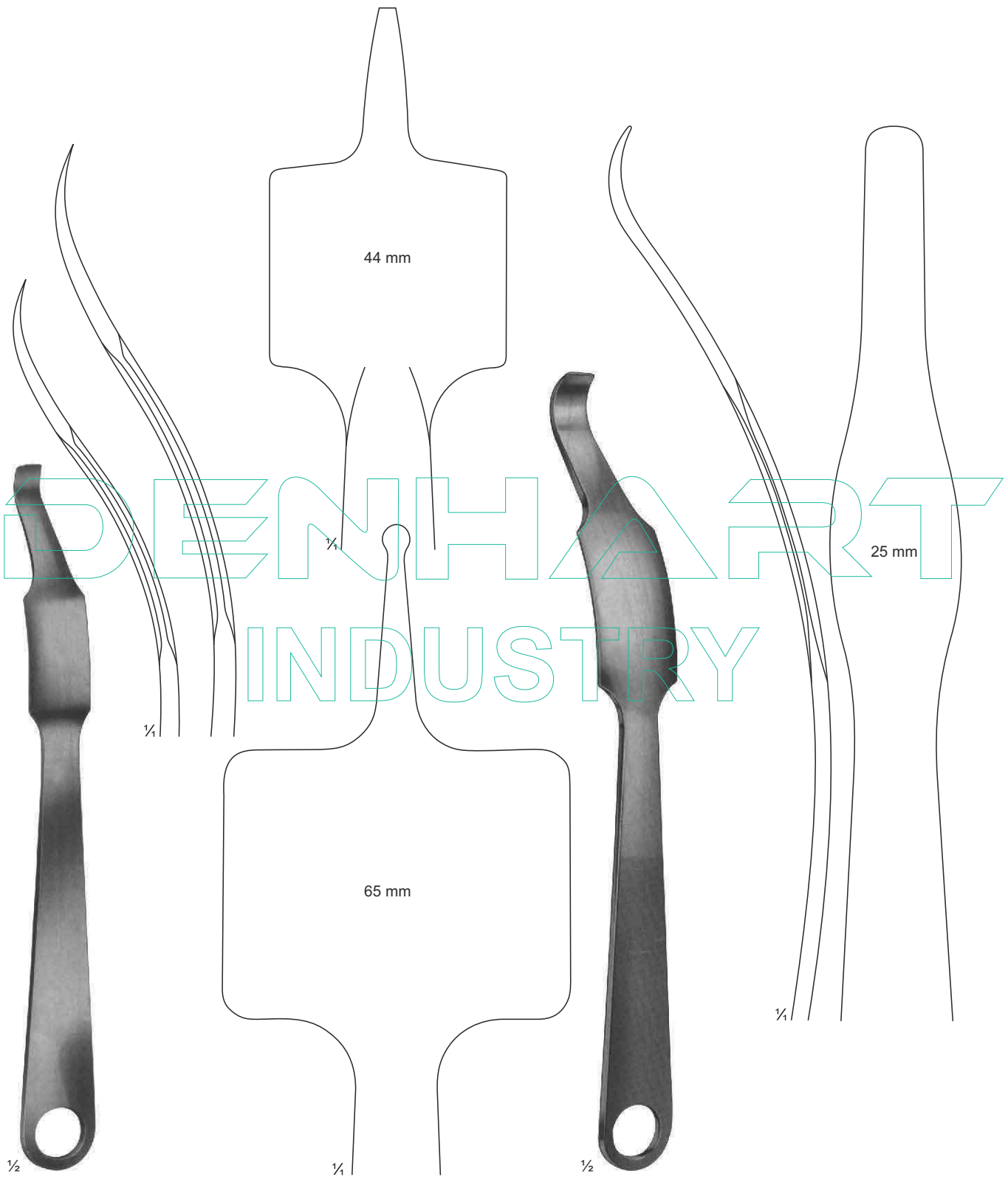

20-125 - 126
VERBRUGGE-MULLER
20-125 240 mm
20-126 255 mm

20-127
260 mm

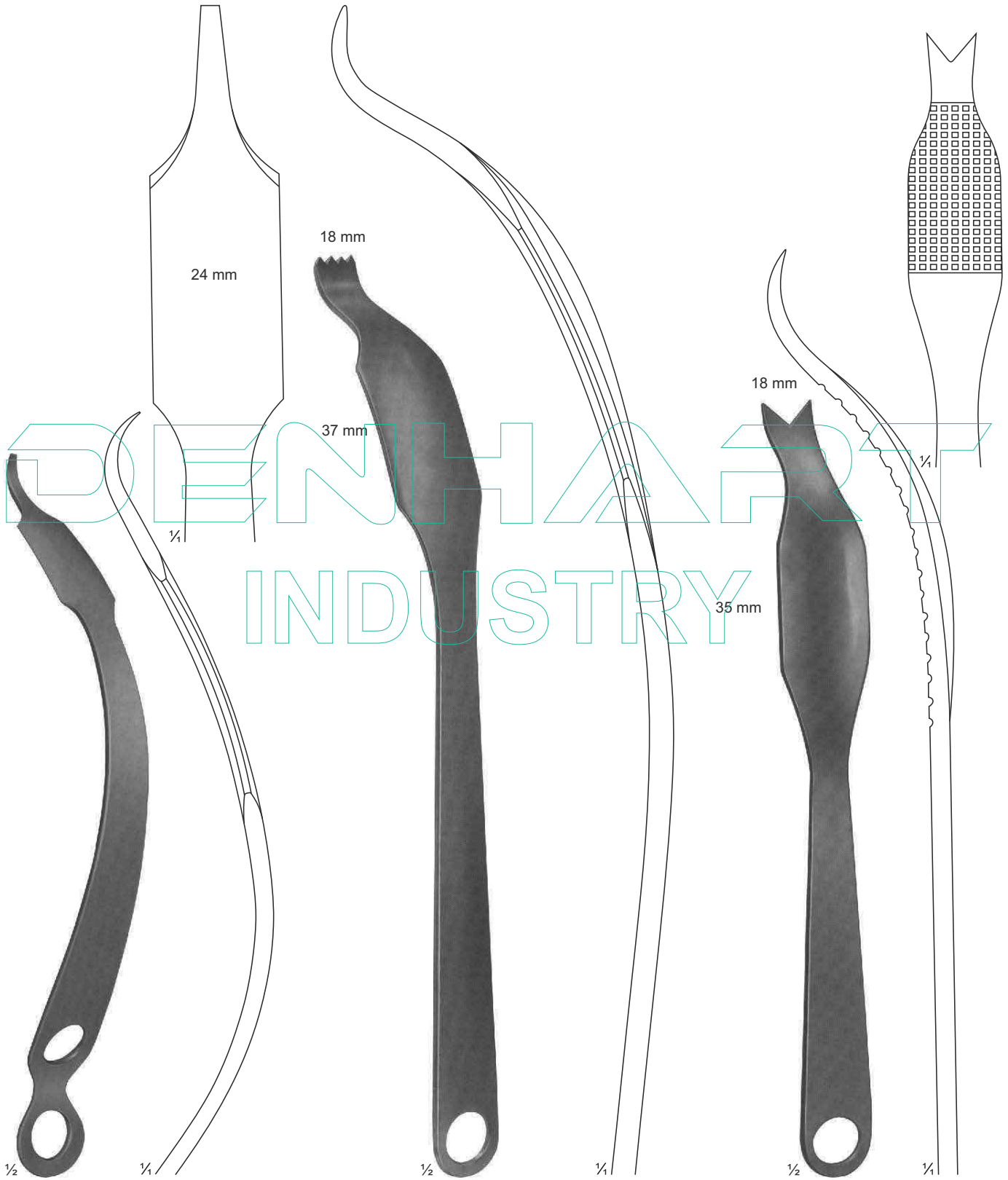

20-128
HOHMANN-ALDINGER
270 mm

20-129
SCHUMACHER mod. WAGNER
345 mm

20-130
SCHUMACHER
290 mm

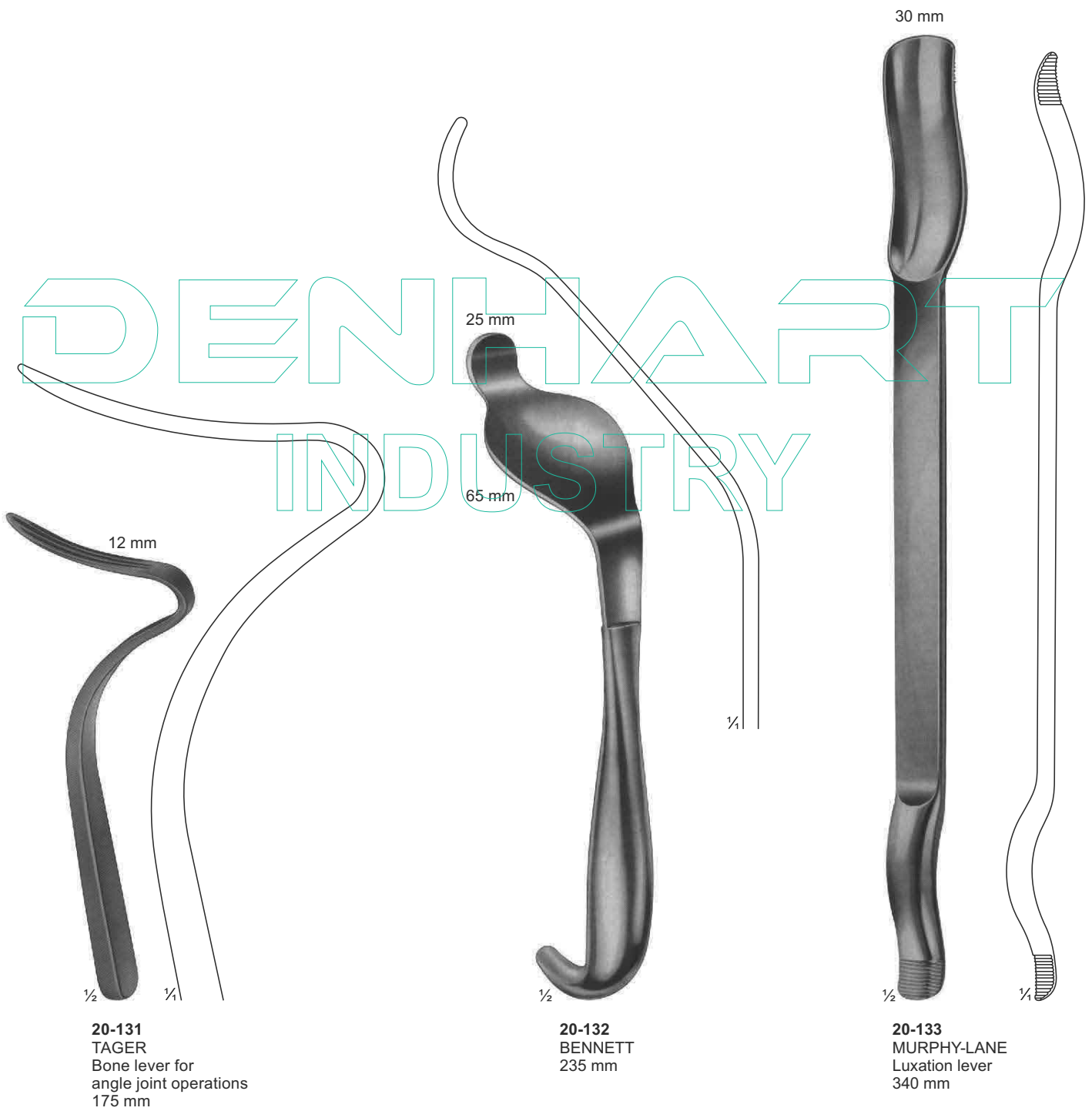

20-131
TAGER
Bone lever for
angle joint operations
175 mm

20-132
BENNETT
235 mm

20-133
MURPHY-LANE
Luxation lever
340 mm

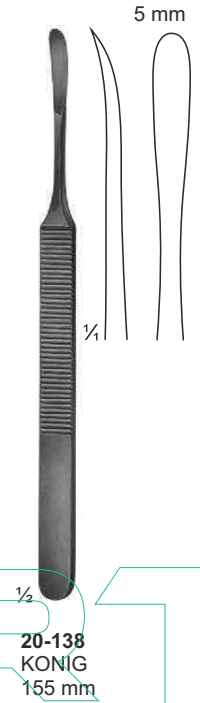
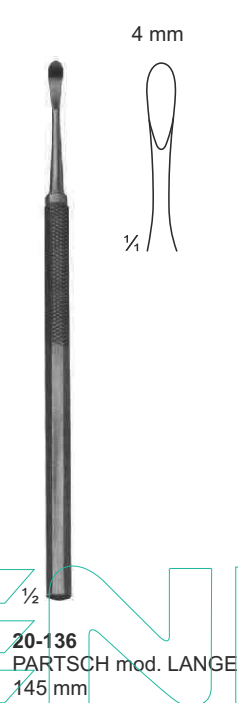
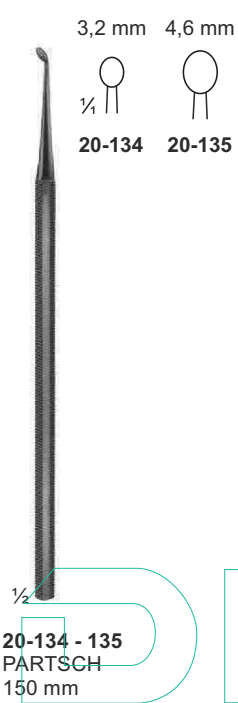

INDUSTRY

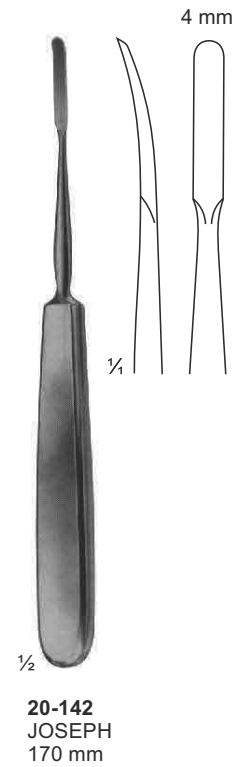
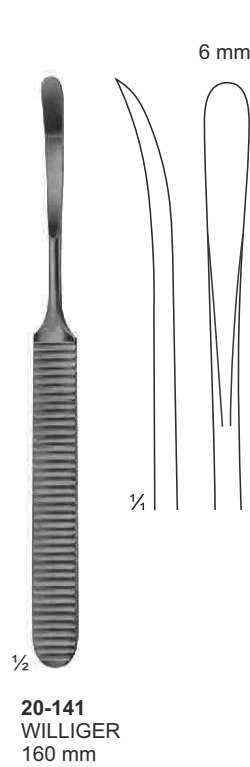
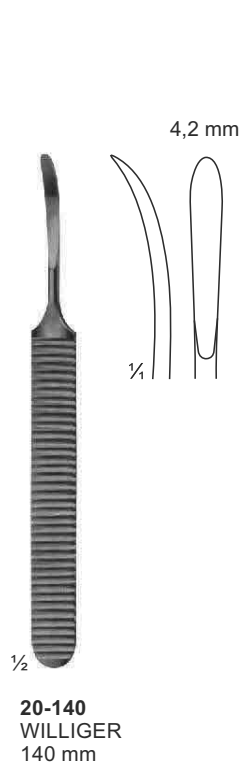
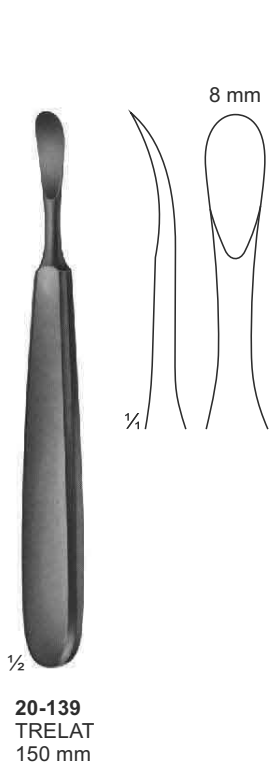



20-143
HALLE
stumpf/blunt
180 mm

20-144
FREER
stumpf/blunt
190 mm

20-145
FREER
stumpf/sharp
190 mm

20-146
SEWALL
stumpf/blunt
190 mm

20-147 - 149
PAULSEN
205 mm

20-150 - 151
PAULSEN
205 mm

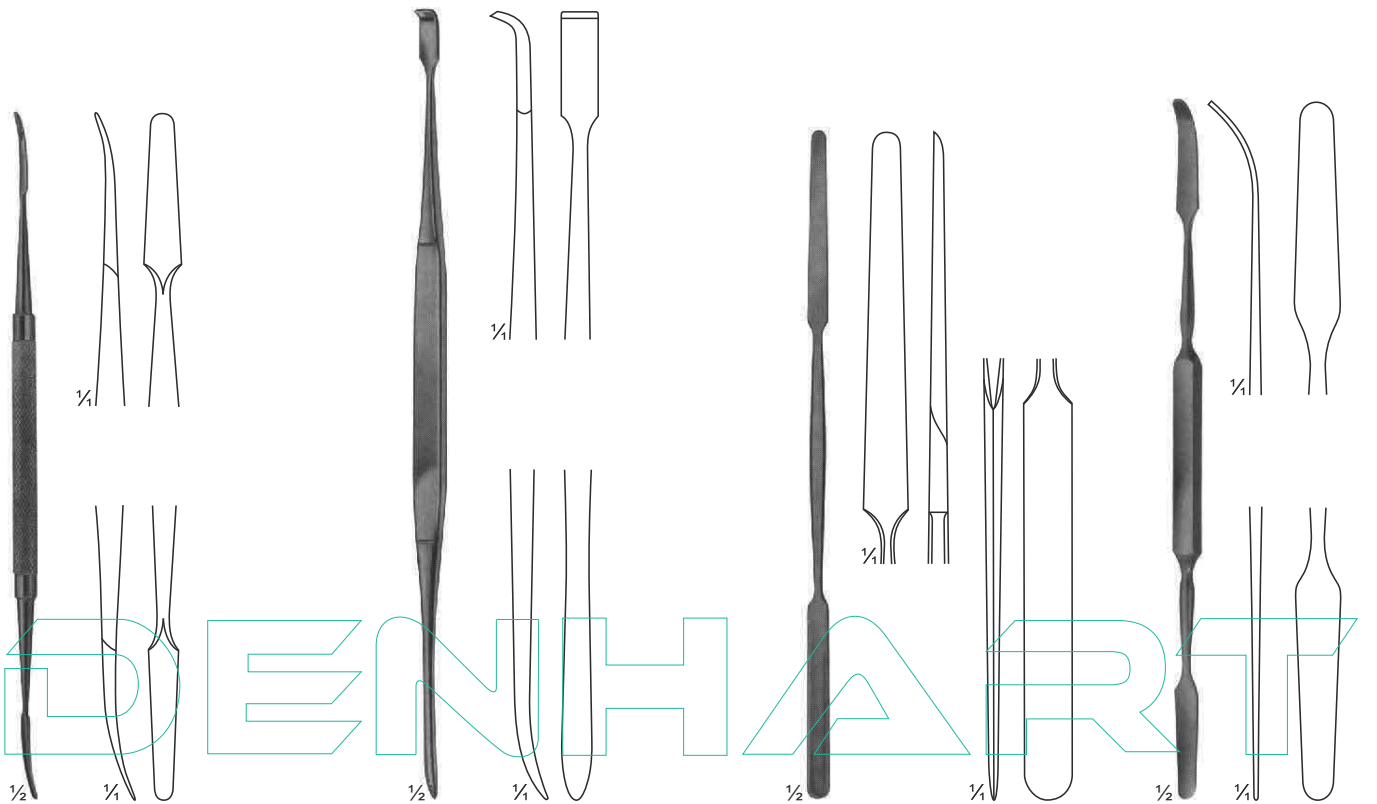

20-152
KILLIAN
sharp/blunt
185 mm

20-153
HOWARTH
sharp/blunt
215 mm

20-154
KILLIAN
sharp/blunt
185 mm

20-155
MAC DONALD
blunt/blunt
185 mm

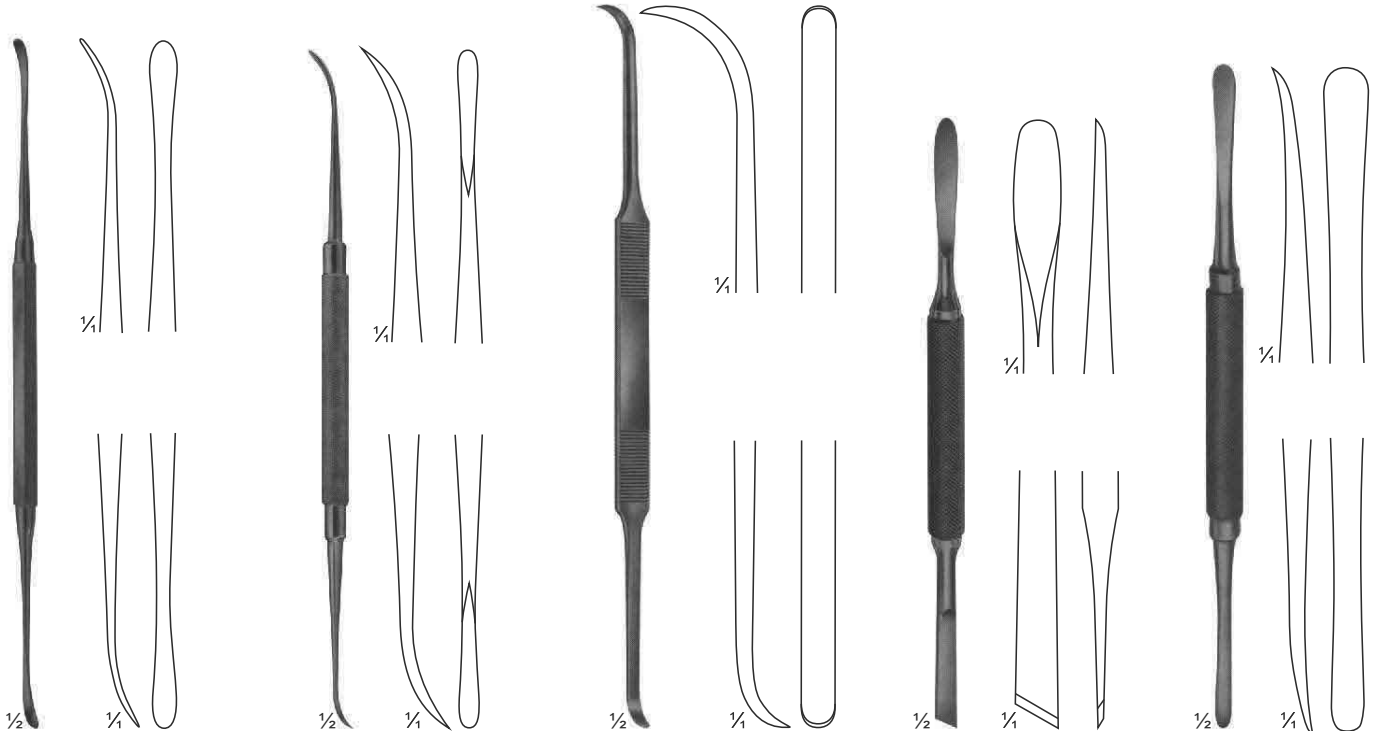

20-156
FREER
sharp/blunt
185 mm

20-157
FREER-YASARGIL
sharp/sharp
185 mm

20-158
COTTLE
sharp/sharp
200 mm

20-159
MEAD
sharp/sharp
165 mm

20-160
MOLT
sharp/sharp
180 mm

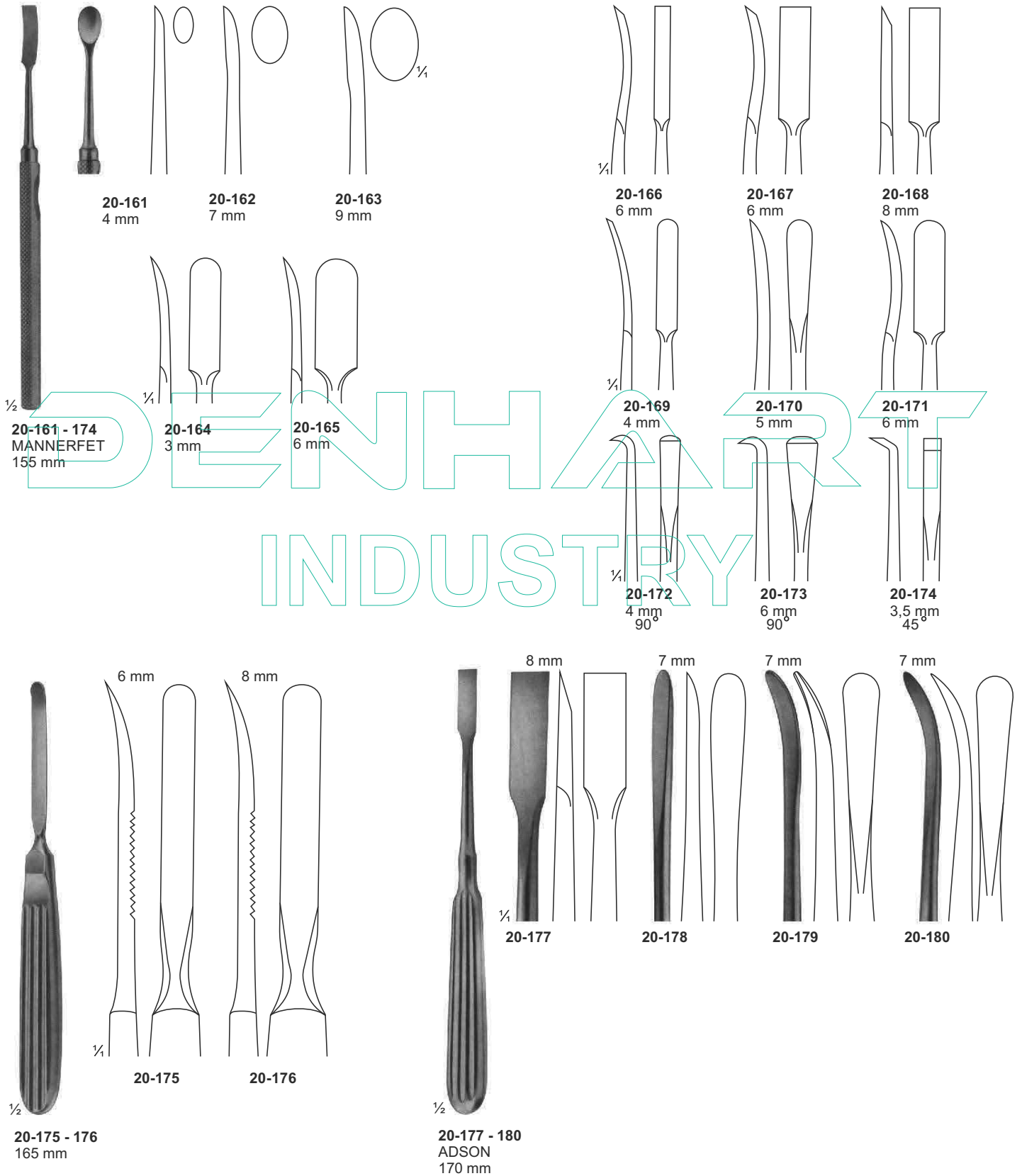

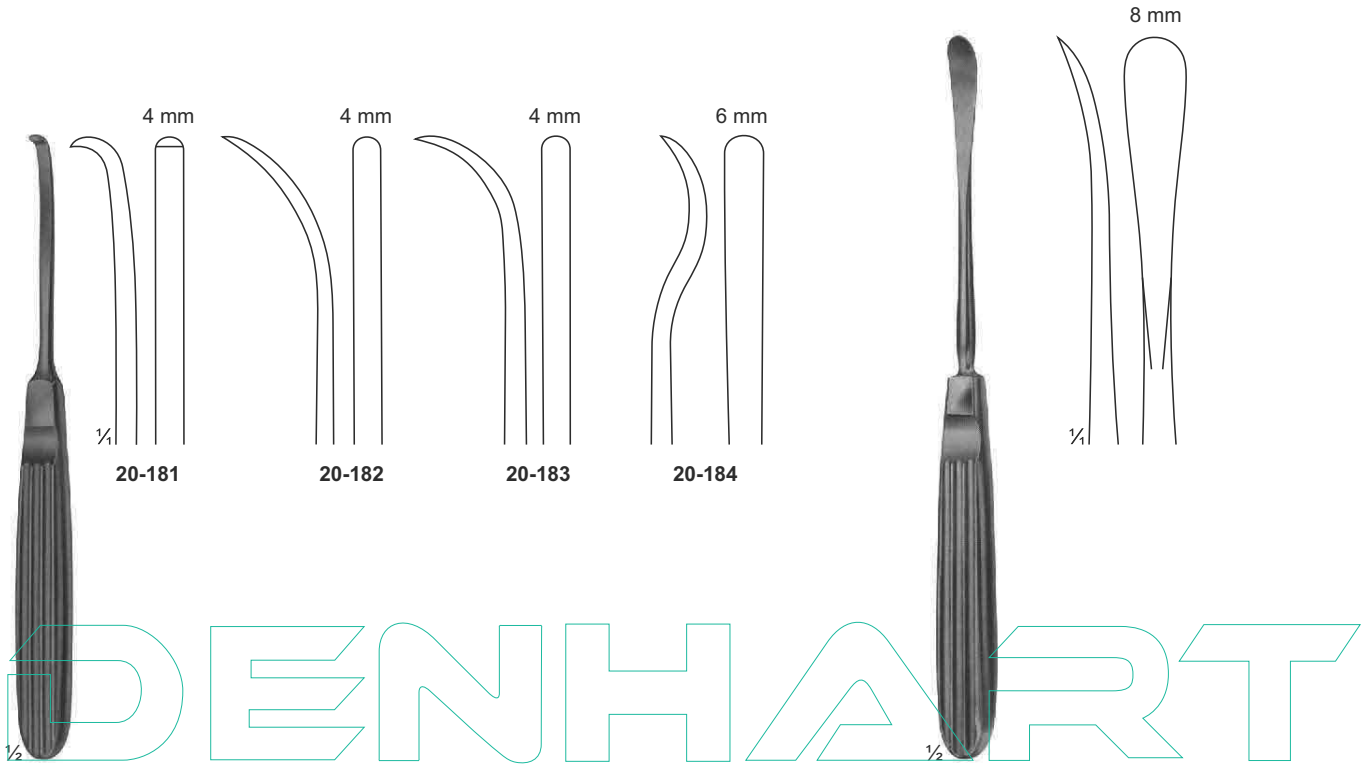
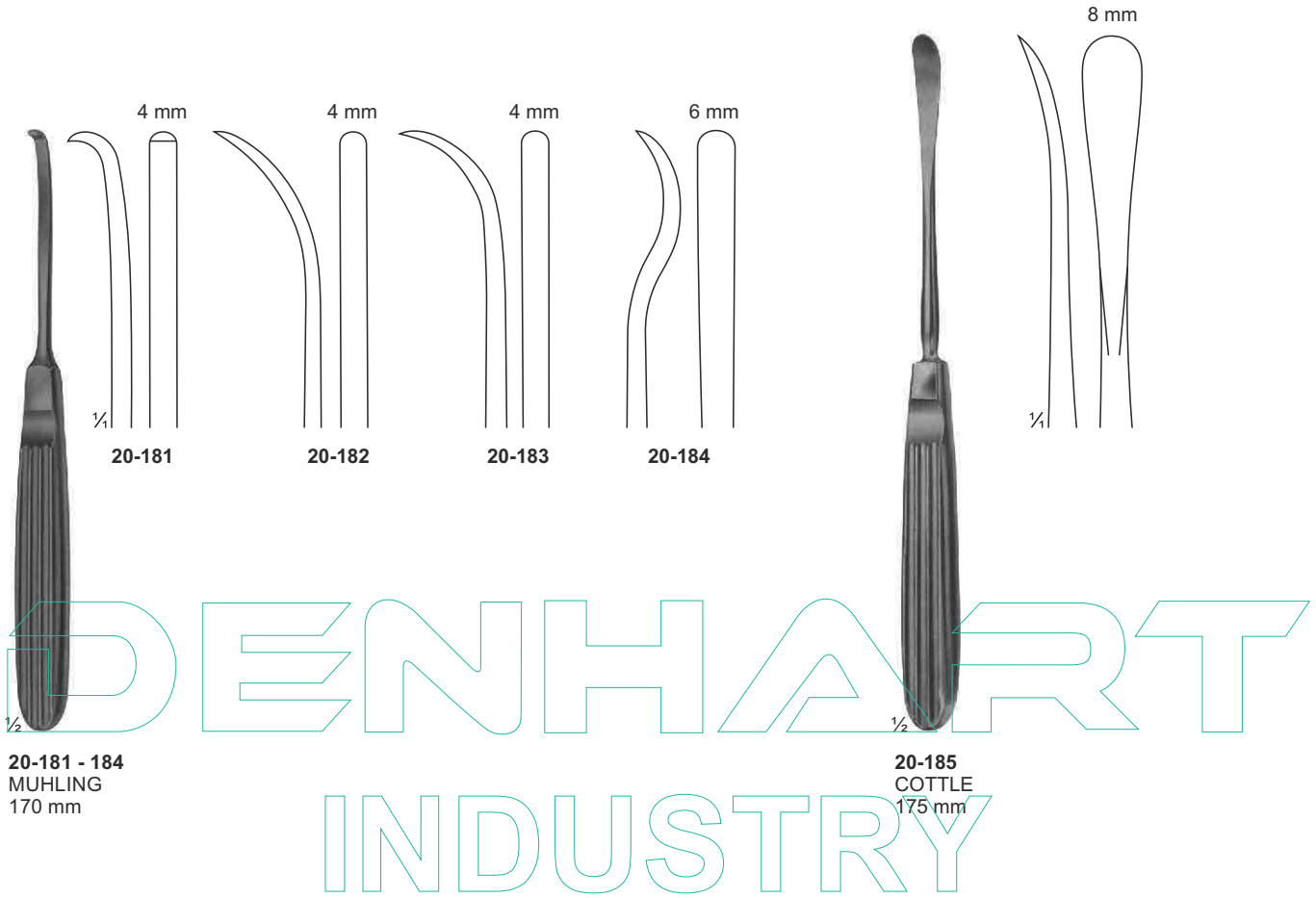

20-181 - 184
MUHLING
170 mm

20-185
COTTLE
175 mm

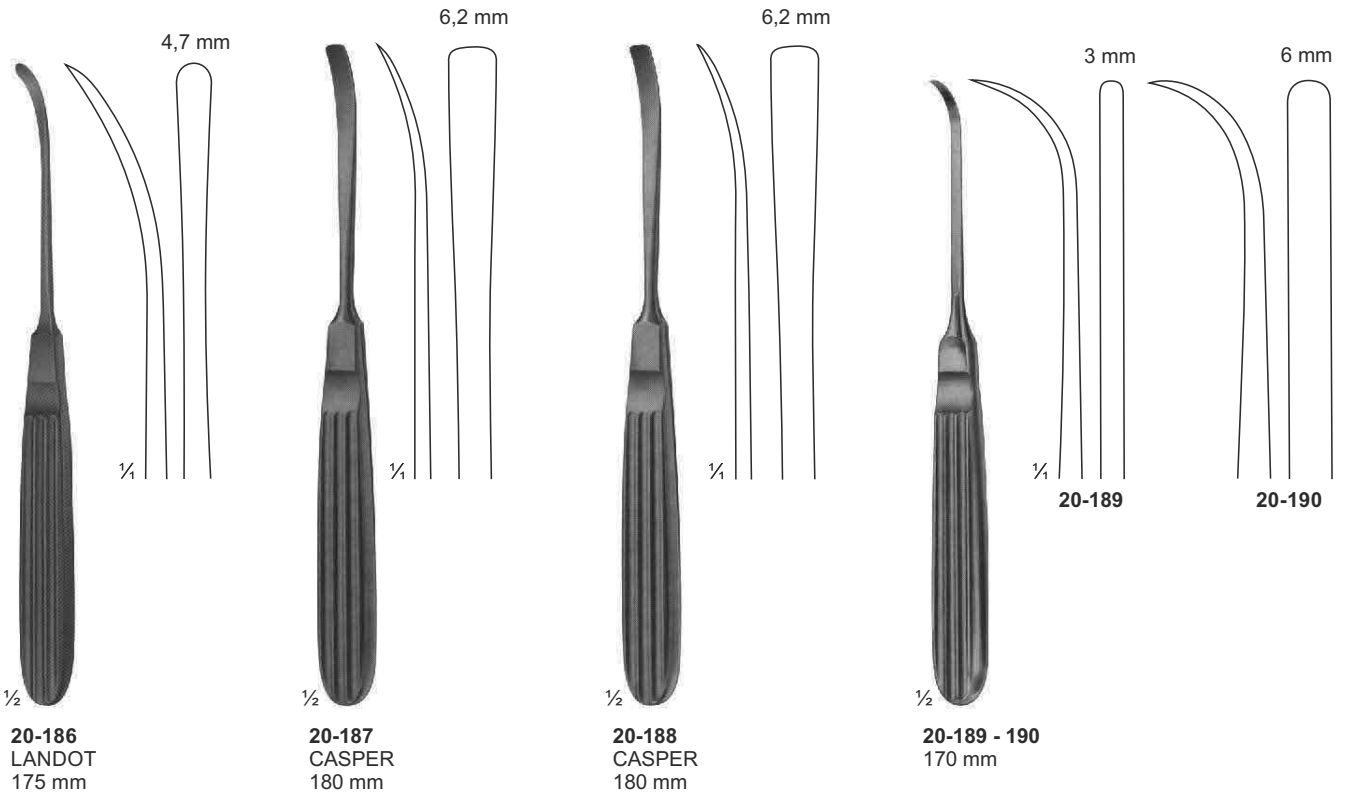

20-186
LANDOT
175 mm

20-187
CASPER
180 mm

20-188
CASPER
180 mm

20-189 - 190
170 mm

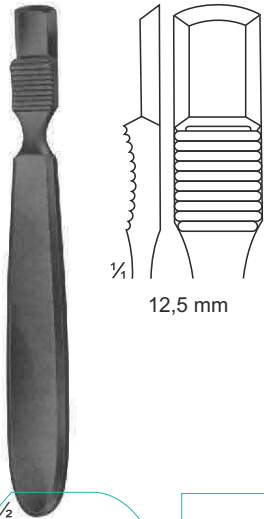

20-191
FARABEUF
140 mm

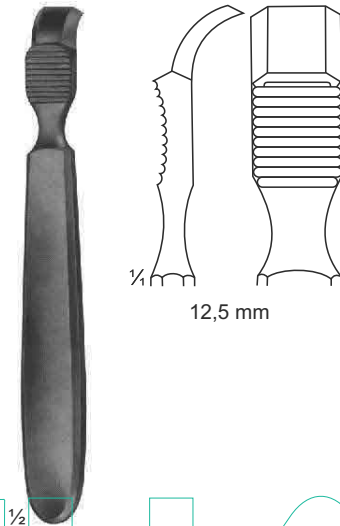

20-192
FARABEUF
140 mm

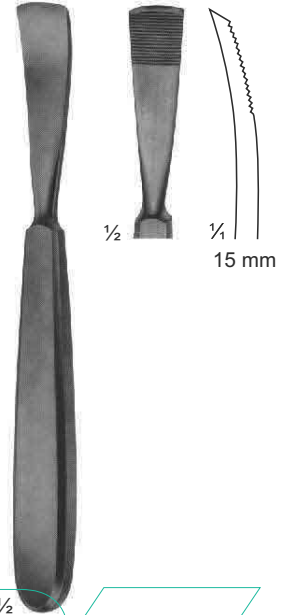

20-193
JANSEN
165 mm

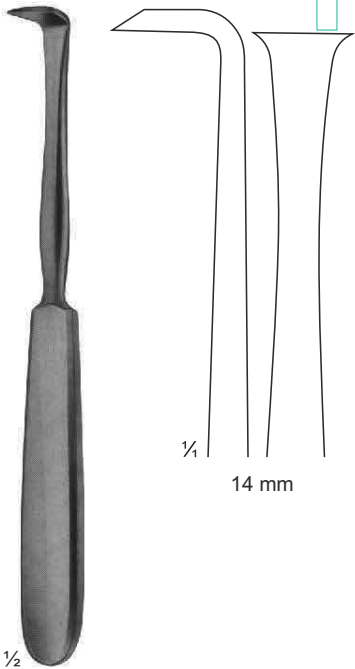

20-194
LANGENBACK
180 mm

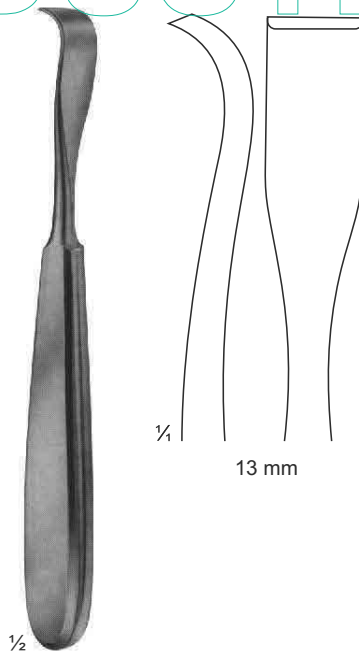

20-195
SCHNEIDER
175 mm

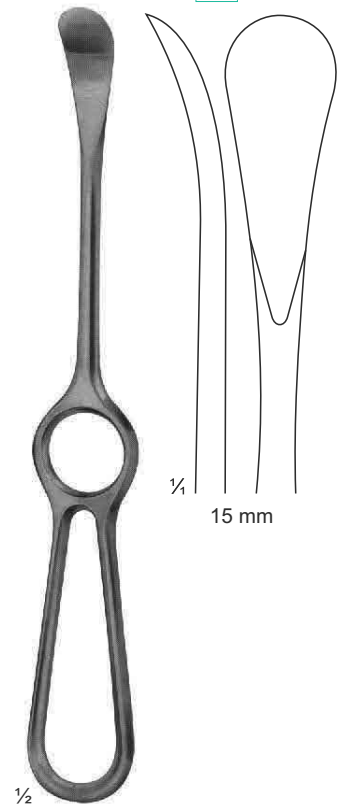

20-196
SEDILLOT
215 mm

DENHART
INDUSTRY

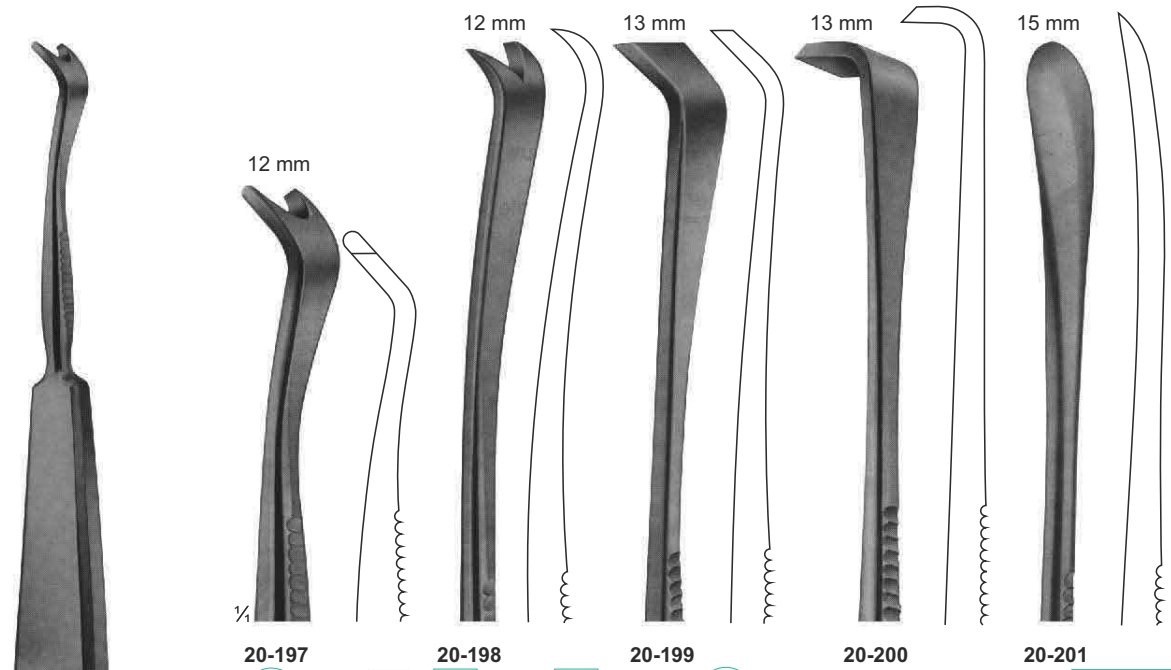

1/2
20-197 - 201
SEMB
230 mm



1/4
20-206
20-207

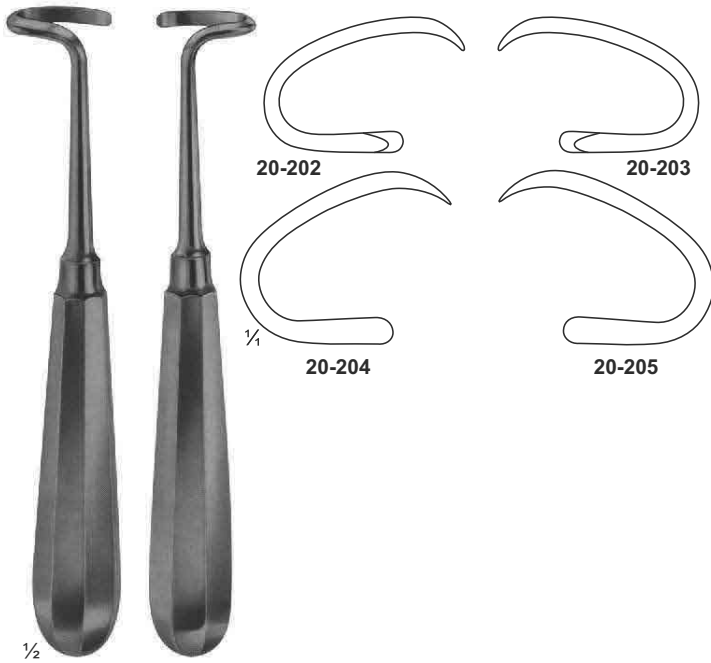

1/2
20-202 - 203
DOYEN
for children
20-204 - 205
DOYEN
for adults
175 mm

1/2
20-206 - 207
DOYEN
240 mm

DENHART
INDUSTRY



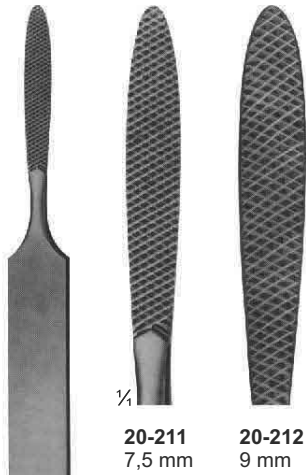

20-211
7,5 mm

20-212
9 mm



20-213
8 mm



20-214
8 mm
coarse, teeth
175 mm

DENHART
INDUSTRY

20-211
JOSEPH
fine, chequered

20-212
coarse, chequered
165 mm

20-213
LEWIS
fine, teeth



20-215
MALTZ
down stroke
180 mm



20-216
AUFRIEHT
up stroke
20-217
down stroke
220 mm

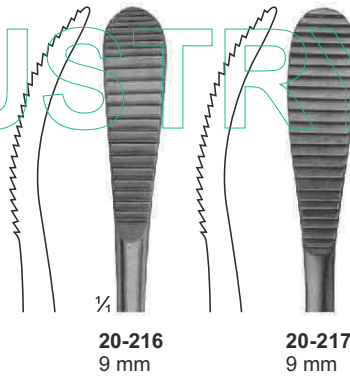

20-216
9 mm

20-217
9 mm



20-218
GALLAHER
190 mm

20-219
6,5 mm

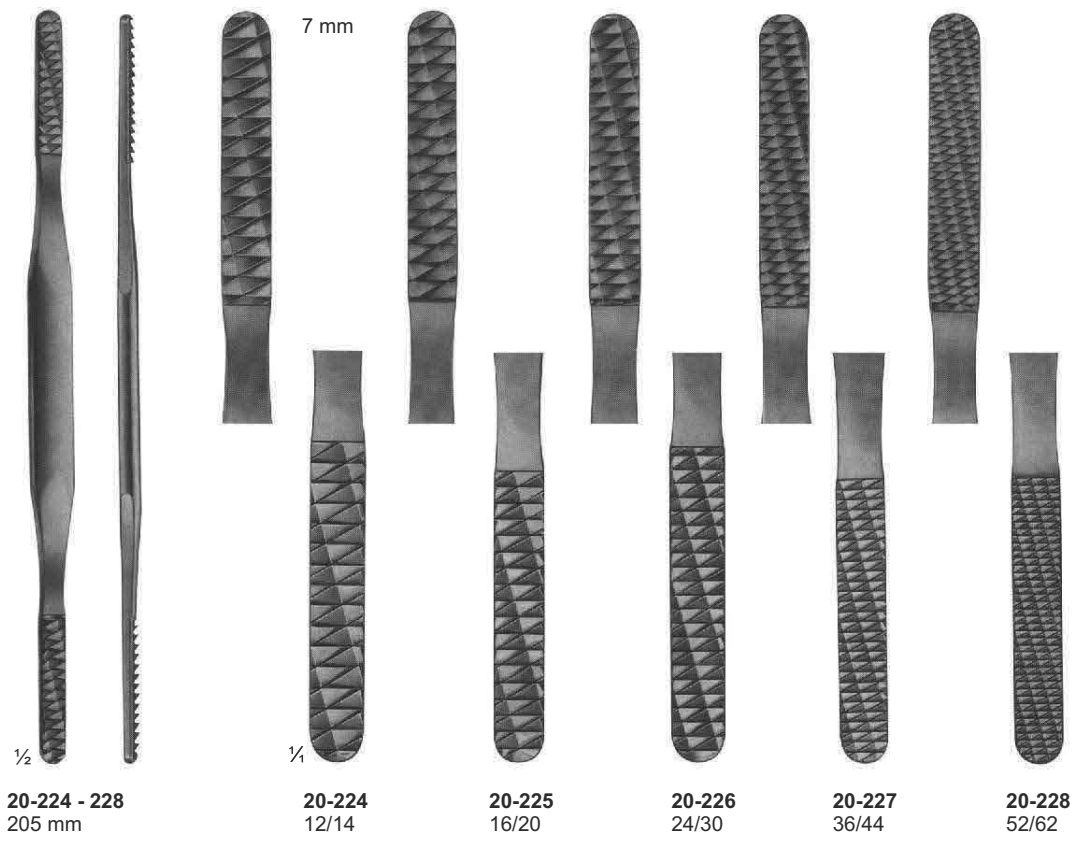

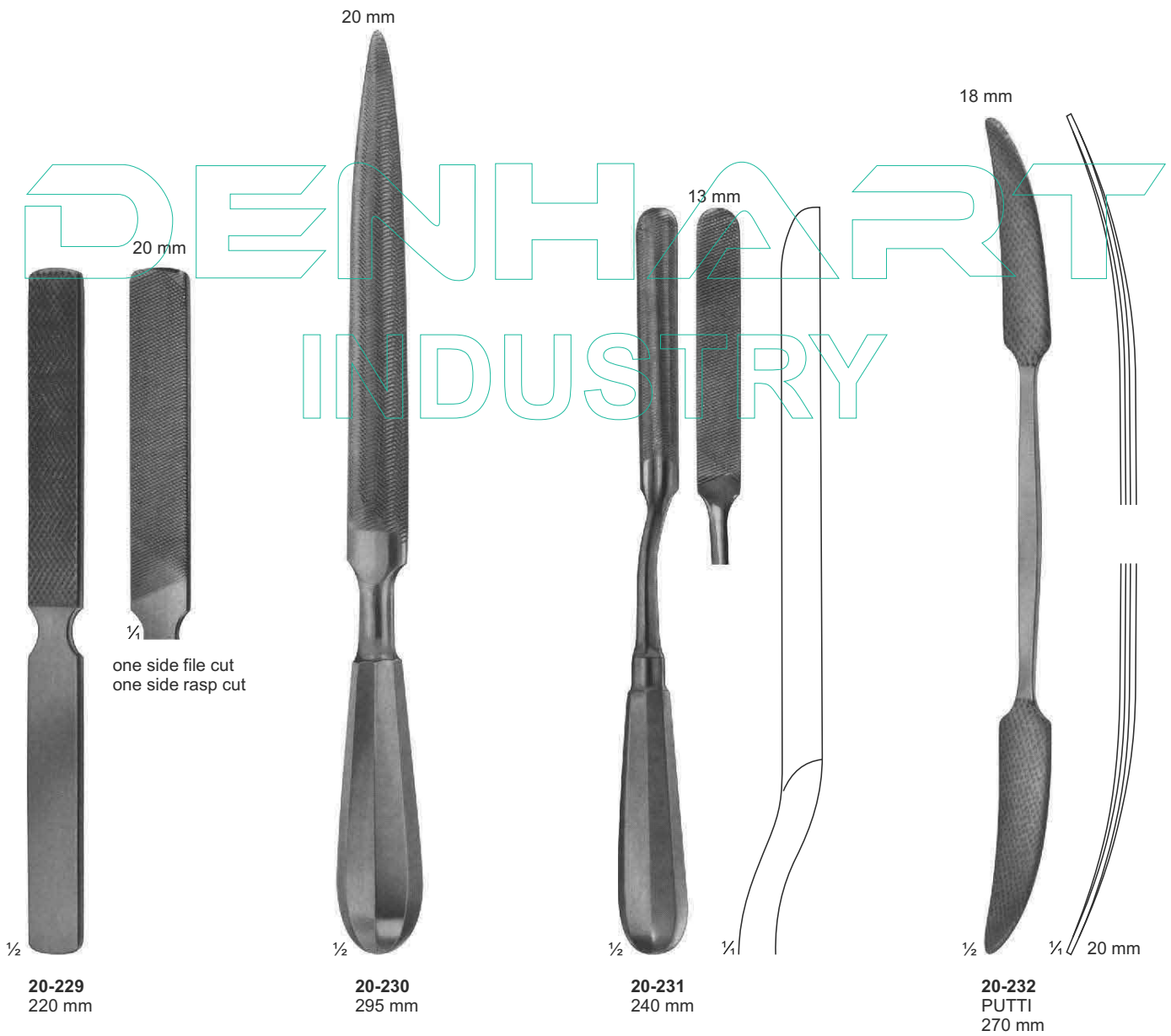

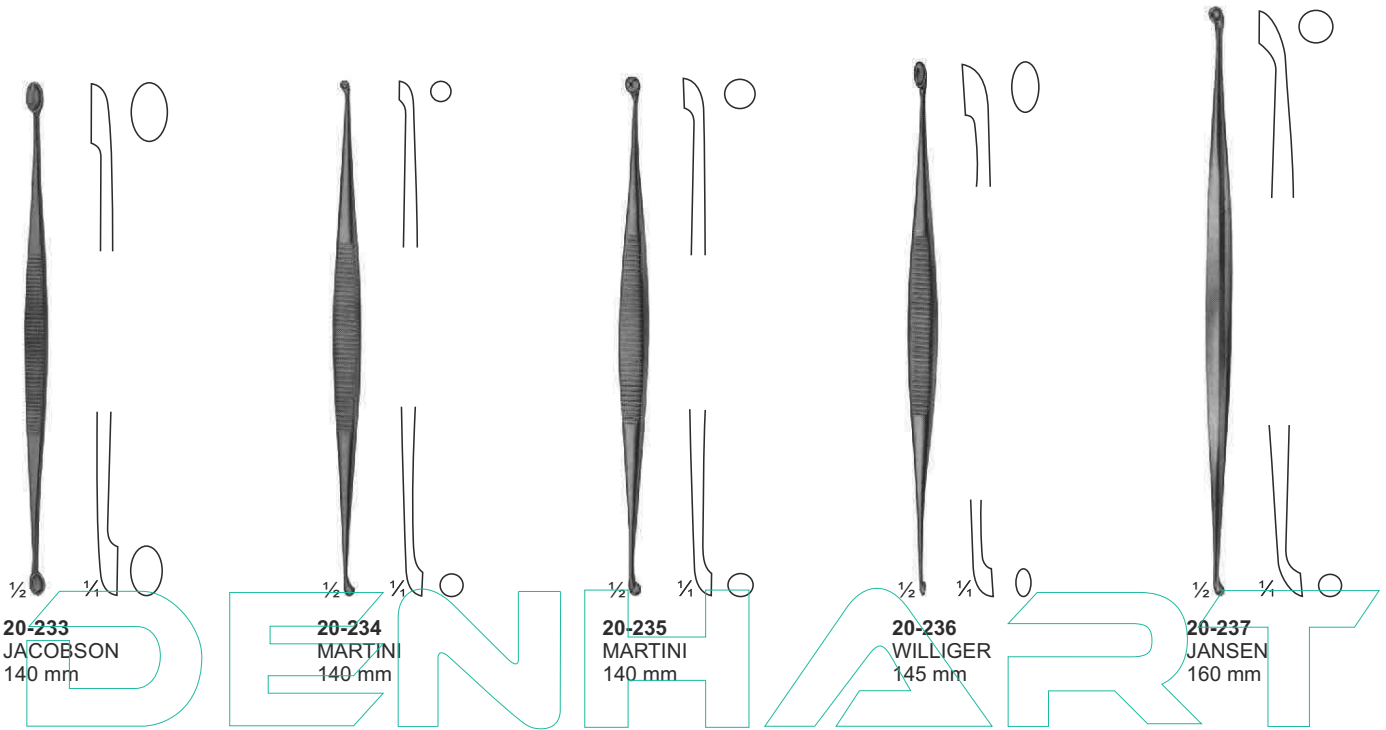

DENHART
INDUSTRY

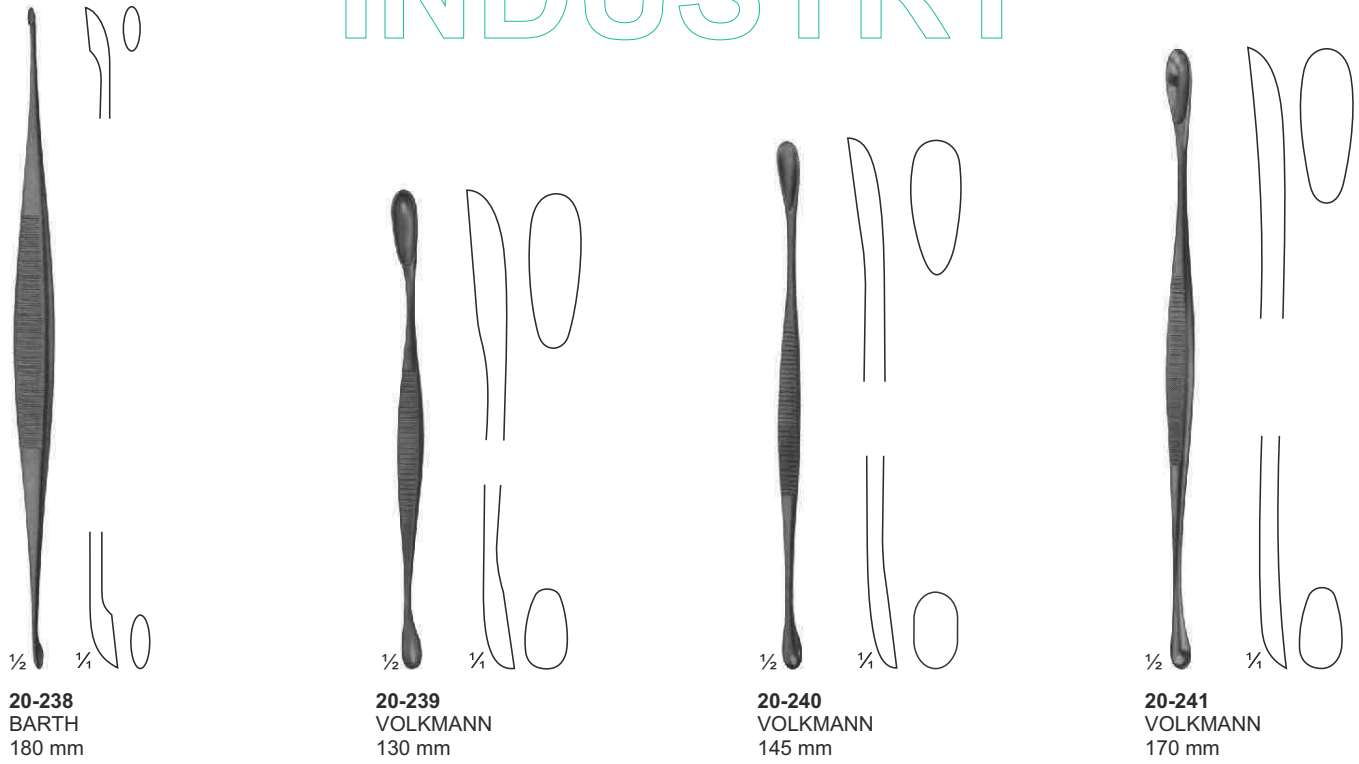

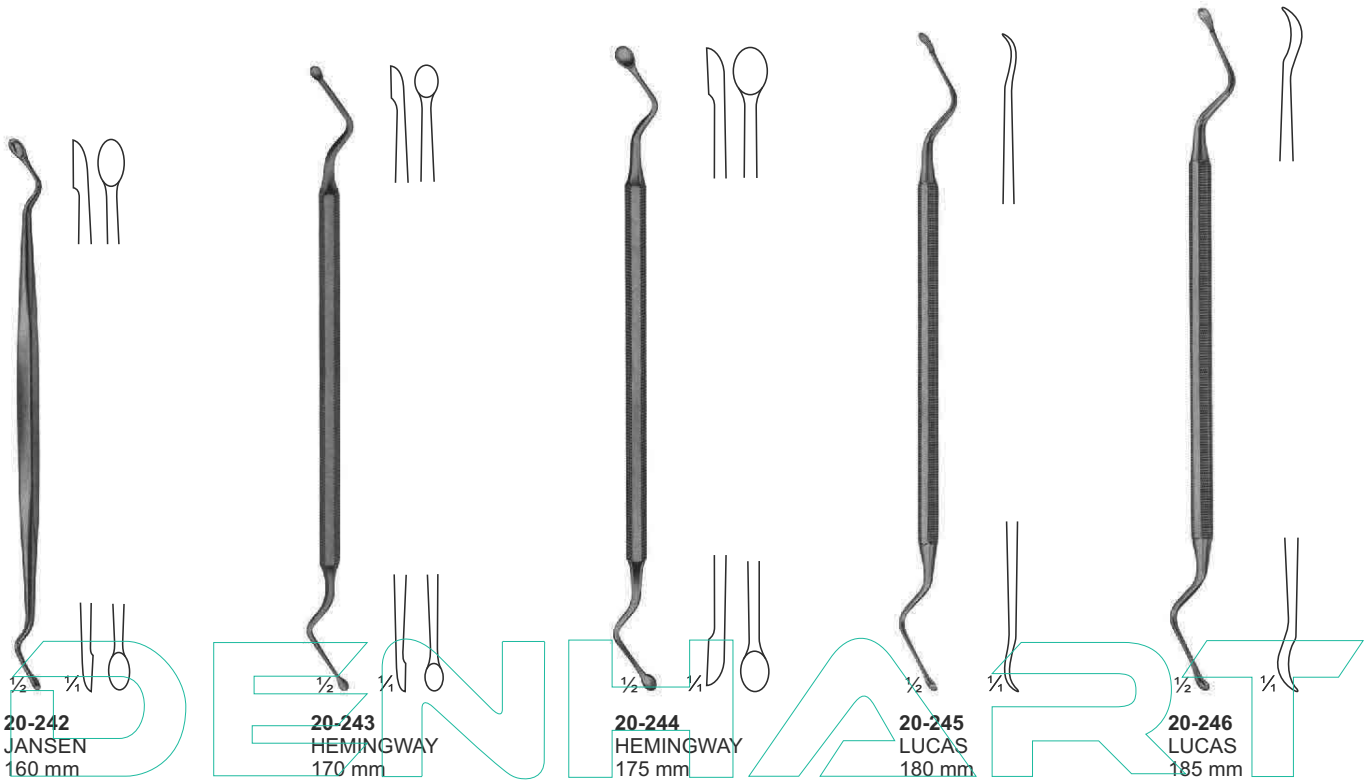

INDUSTRY

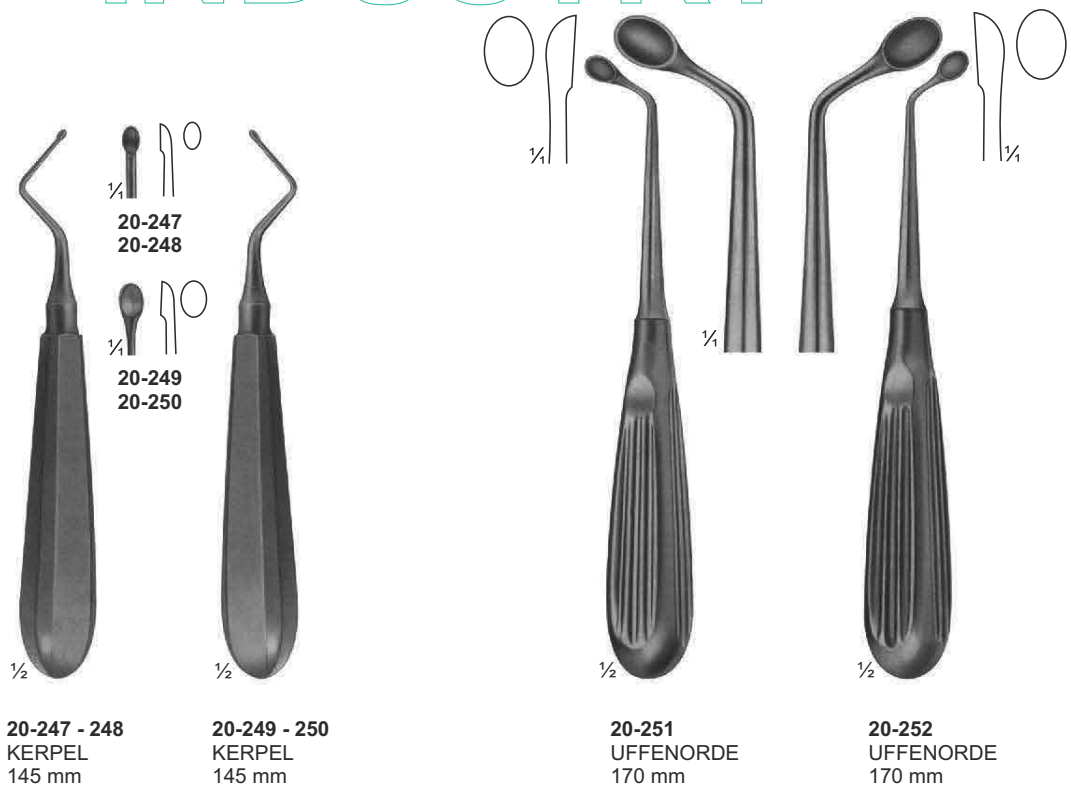

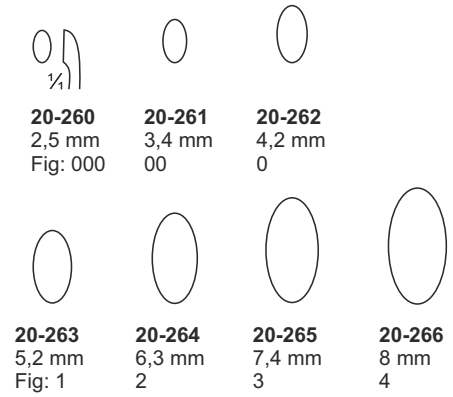
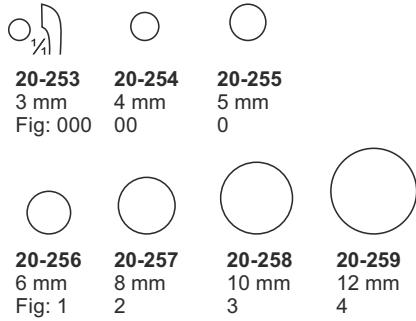

20-253 - 259
BRUNS
165 mm

20-260 - 266
SCHEDE
170 mm

DENHART INDUSTRY

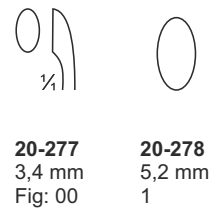
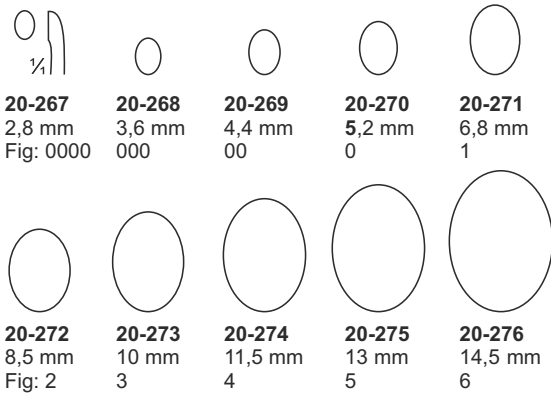

20-267 - 276
VOLKMANN
170 mm

20-277 - 278
WILLIGER
170 mm

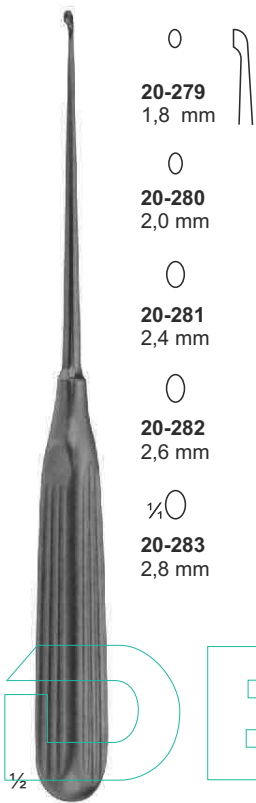

- 20-279**
1,8 mm
- 20-280**
2,0 mm
- 20-281**
2,4 mm
- 20-282**
2,6 mm
- 20-283**
2,8 mm

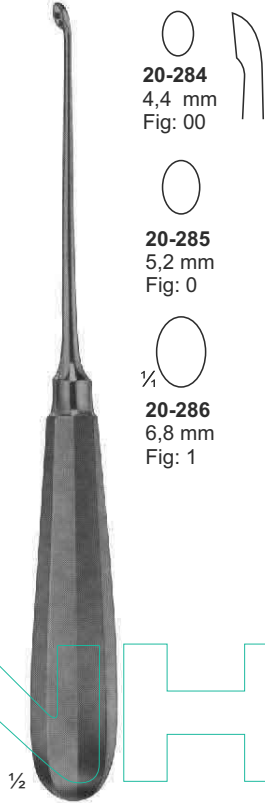

- 20-284**
4,4 mm
Fig: 00
- 20-285**
5,2 mm
Fig: 0
- 20-286**
6,8 mm
Fig: 1

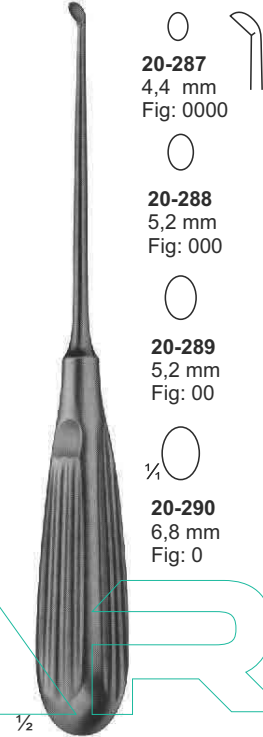

- 20-287**
4,4 mm
Fig: 0000
- 20-288**
5,2 mm
Fig: 000
- 20-289**
5,2 mm
Fig: 00
- 20-290**
6,8 mm
Fig: 0

20-279 - 283
LEMPERT
215 mm

20-284 - 286
HALLE
215 mm

20-287 - 290
DAUBENSPECK
200 mm



- 20-291**
3,6 mm
Fig: 000
- 20-292**
4,4 mm
Fig: 00
- 20-293**
5,2 mm
Fig: 0
- 20-294**
6,8 mm
Fig: 1

20-291 - 294
250 mm



- 20-295**
3,6 mm
Fig: 000
- 20-296**
4,4 mm
Fig: 00
- 20-297**
5,2 mm
Fig: 0
- 20-298**
6,8 mm
Fig: 1

20-295 - 298
250 mm



- 20-299**
3 mm
- 20-300**
4 mm
- 20-301**
5 mm

20-299 - 301
BUSHE
250 mm



6 mm

1/4

20-302
TESSIER
220 mm

1/2

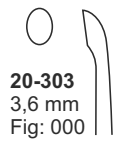

20-303
3,6 mm
Fig: 000



20-304
4,4 mm
Fig: 00



20-305
5,2 mm
Fig: 0

20-303 - 305
SIMON
235 mm

1/2

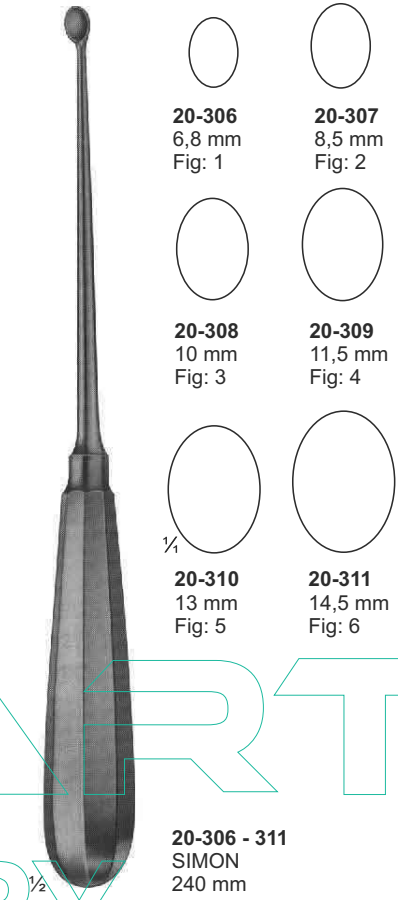

20-306
6,8 mm
Fig: 1

20-307
8,5 mm
Fig: 2

20-308
10 mm
Fig: 3

20-309
11,5 mm
Fig: 4

20-310
13 mm
Fig: 5

20-311
14,5 mm
Fig: 6

20-306 - 311
SIMON
240 mm

1/2

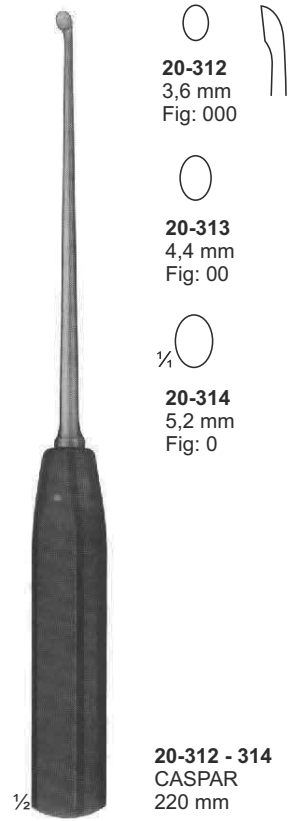

20-312
3,6 mm
Fig: 000

20-313
4,4 mm
Fig: 00

20-314
5,2 mm
Fig: 0

20-312 - 314
CASPAR
220 mm

1/2

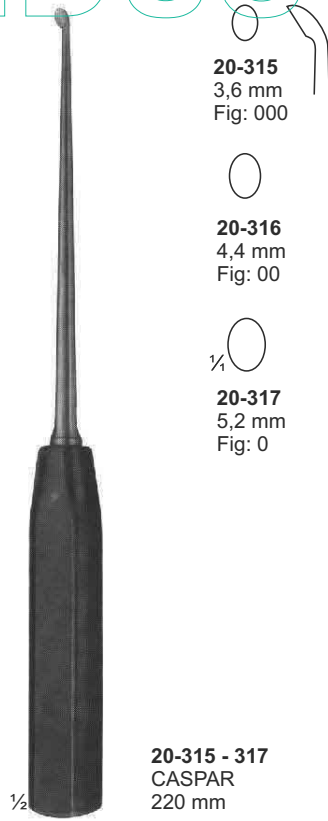

20-315
3,6 mm
Fig: 000

20-316
4,4 mm
Fig: 00

20-317
5,2 mm
Fig: 0

20-315 - 317
CASPAR
220 mm

1/2

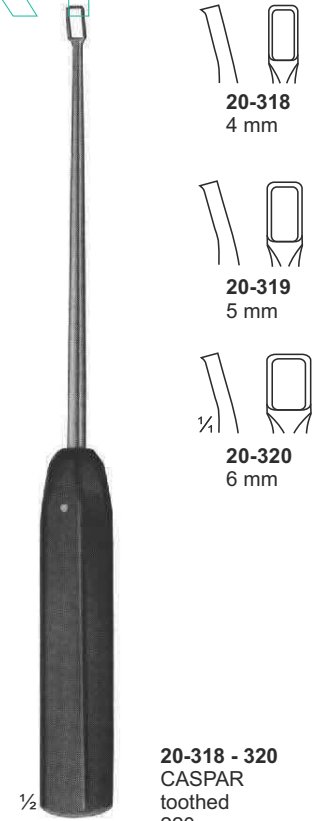

20-318
4 mm

20-319
5 mm

20-320
6 mm

20-318 - 320
CASPAR
toothed
220 mm

1/2

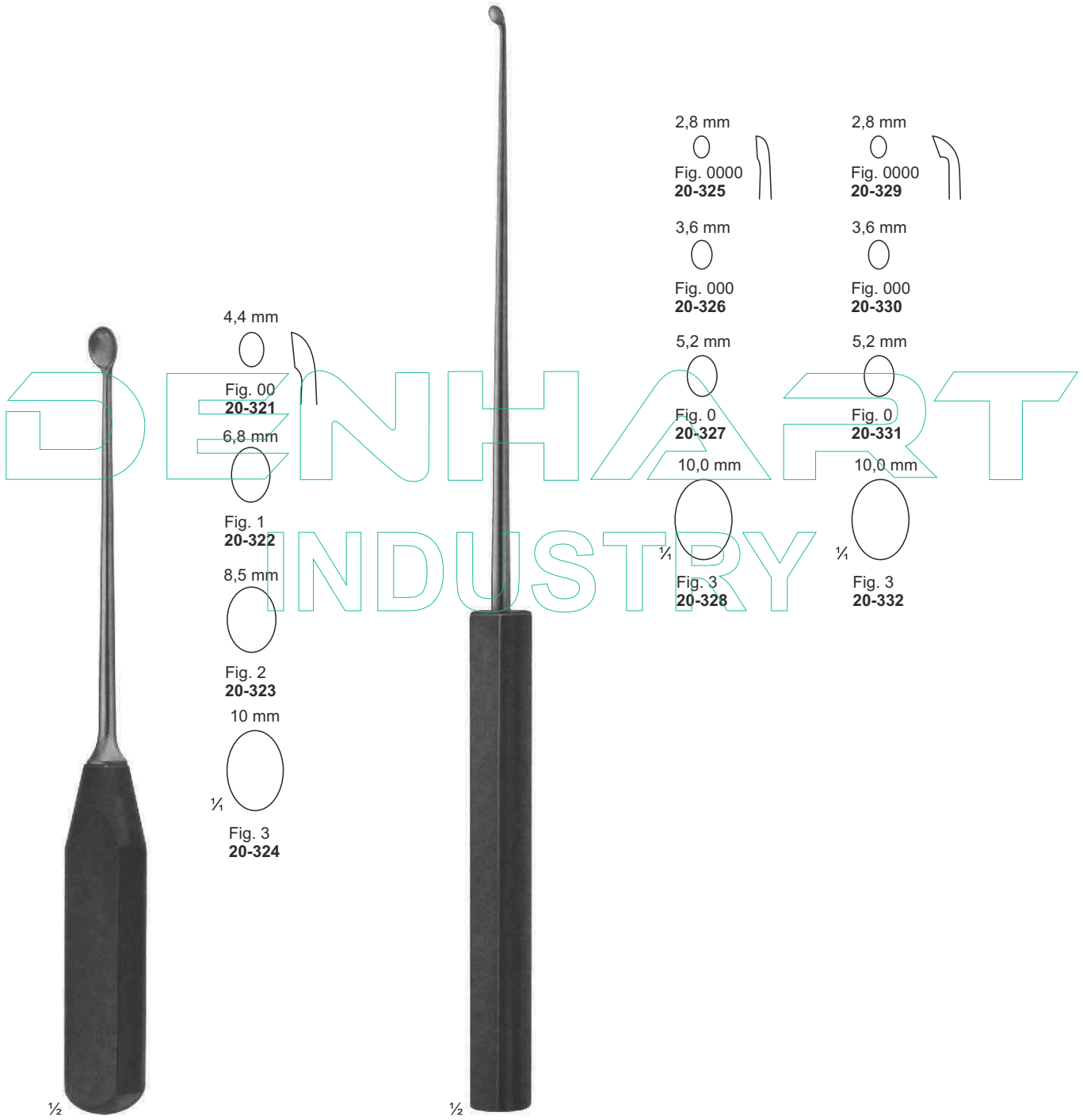

20-321 - 324
270 mm

20-325 - 332
SYPERT
380 mm



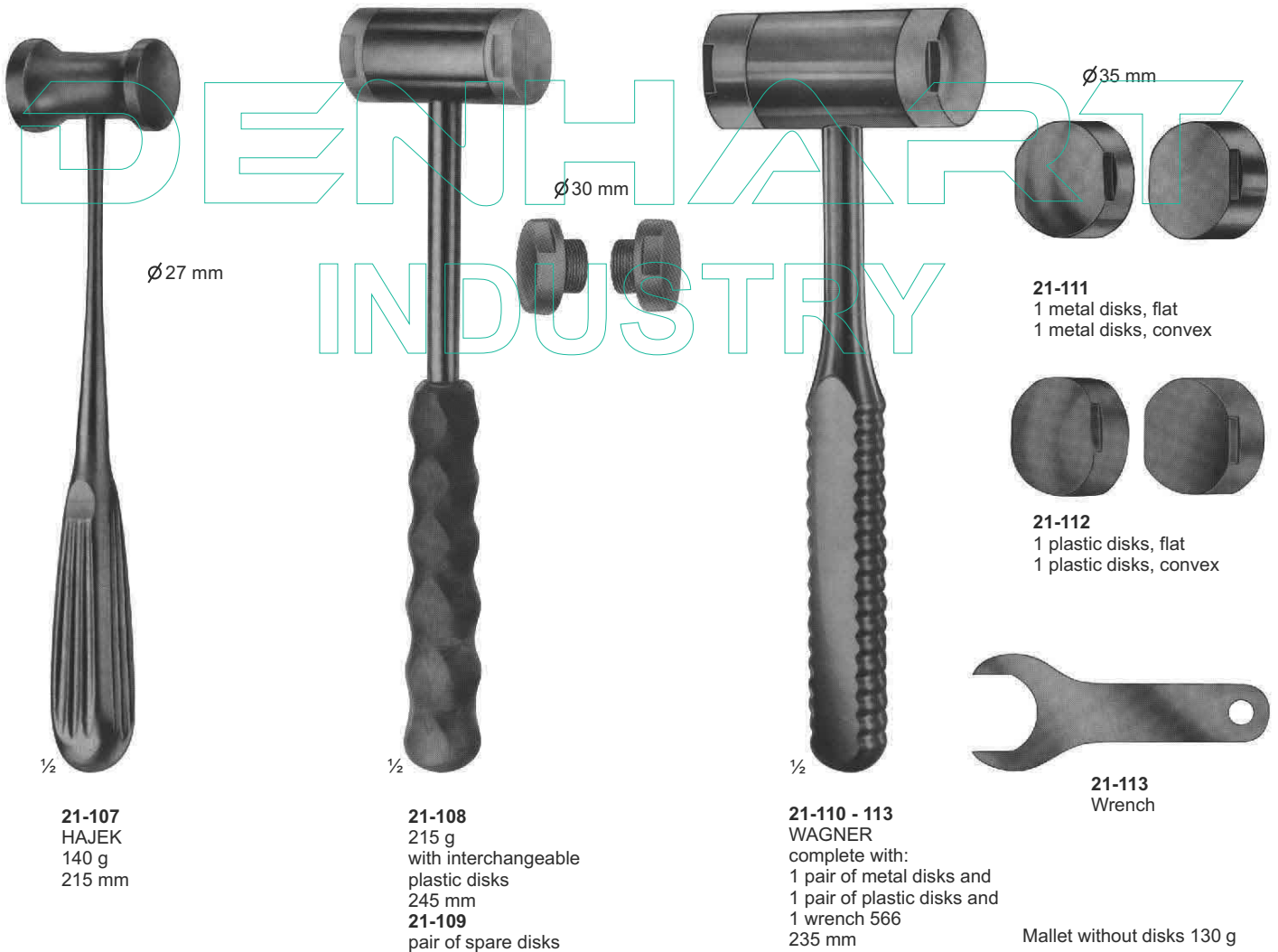

1/2
21-107
HAJEK
140 g
215 mm

1/2
21-108
215 g
with interchangeable
plastic disks
245 mm
21-109
pair of spare disks

1/2
21-110 - 113
WAGNER
complete with:
1 pair of metal disks and
1 pair of plastic disks and
1 wrench 566
235 mm

21-111
1 metal disks, flat
1 metal disks, convex

21-112
1 plastic disks, flat
1 plastic disks, convex

21-113
Wrench

Mallet without disks 130 g

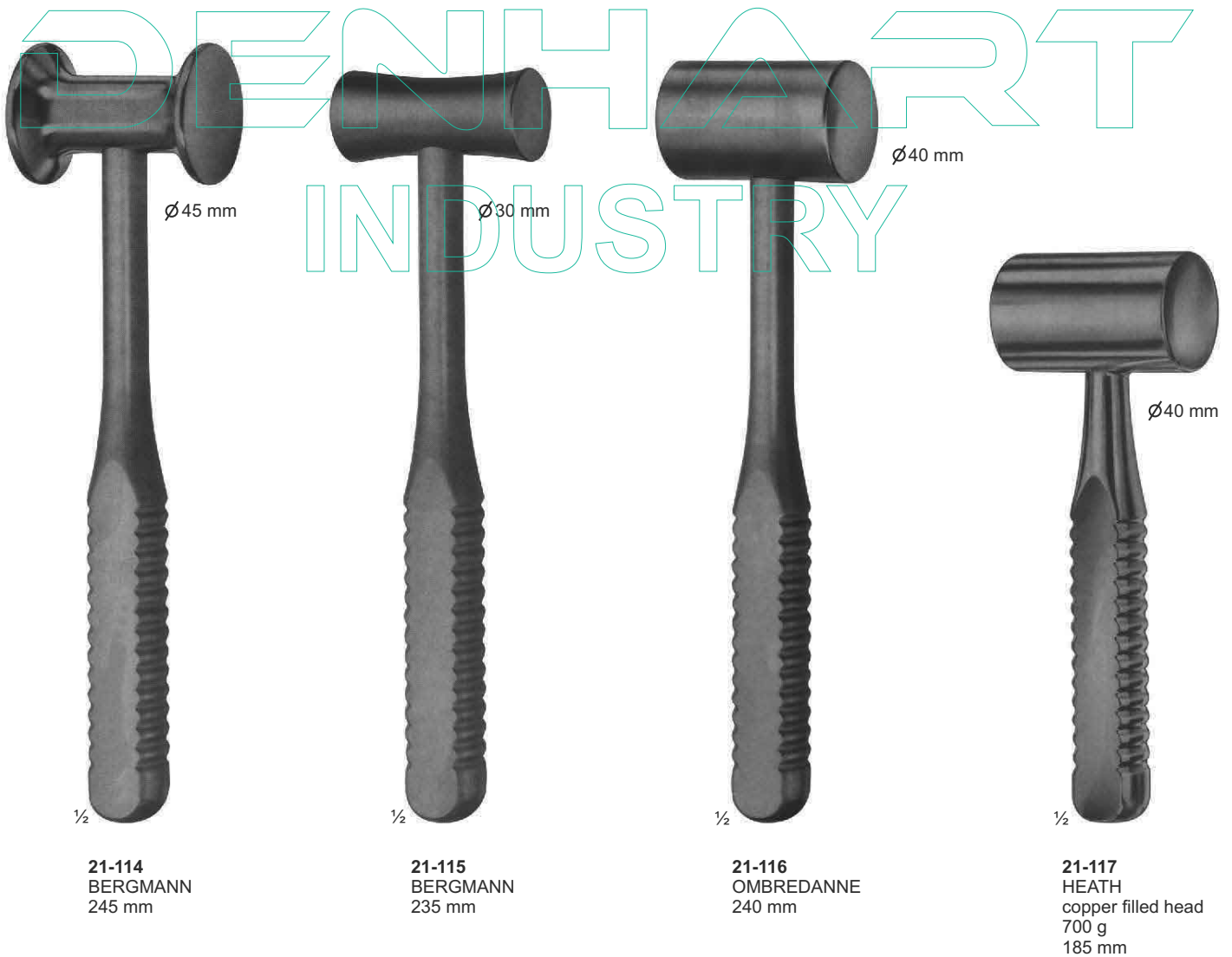

Tampers - Osteotomes, Chisels and Gouges

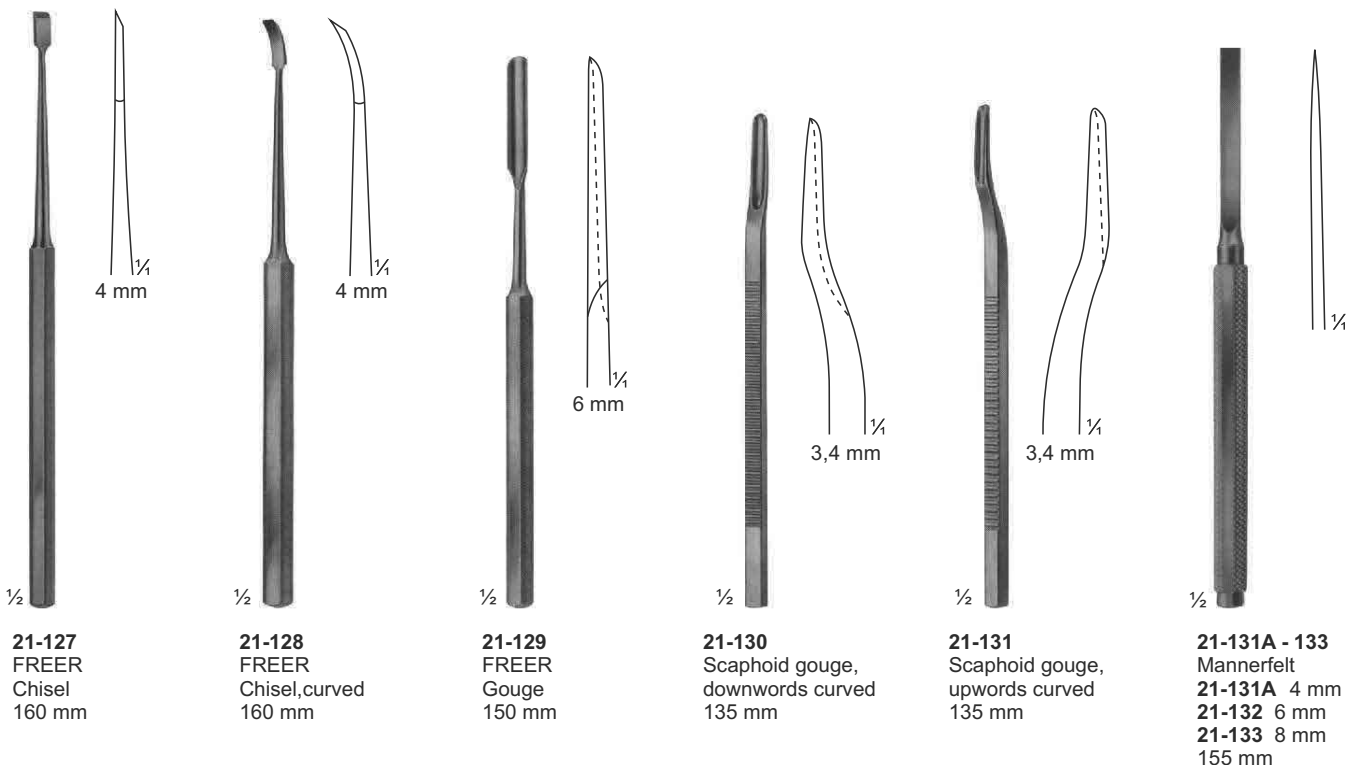
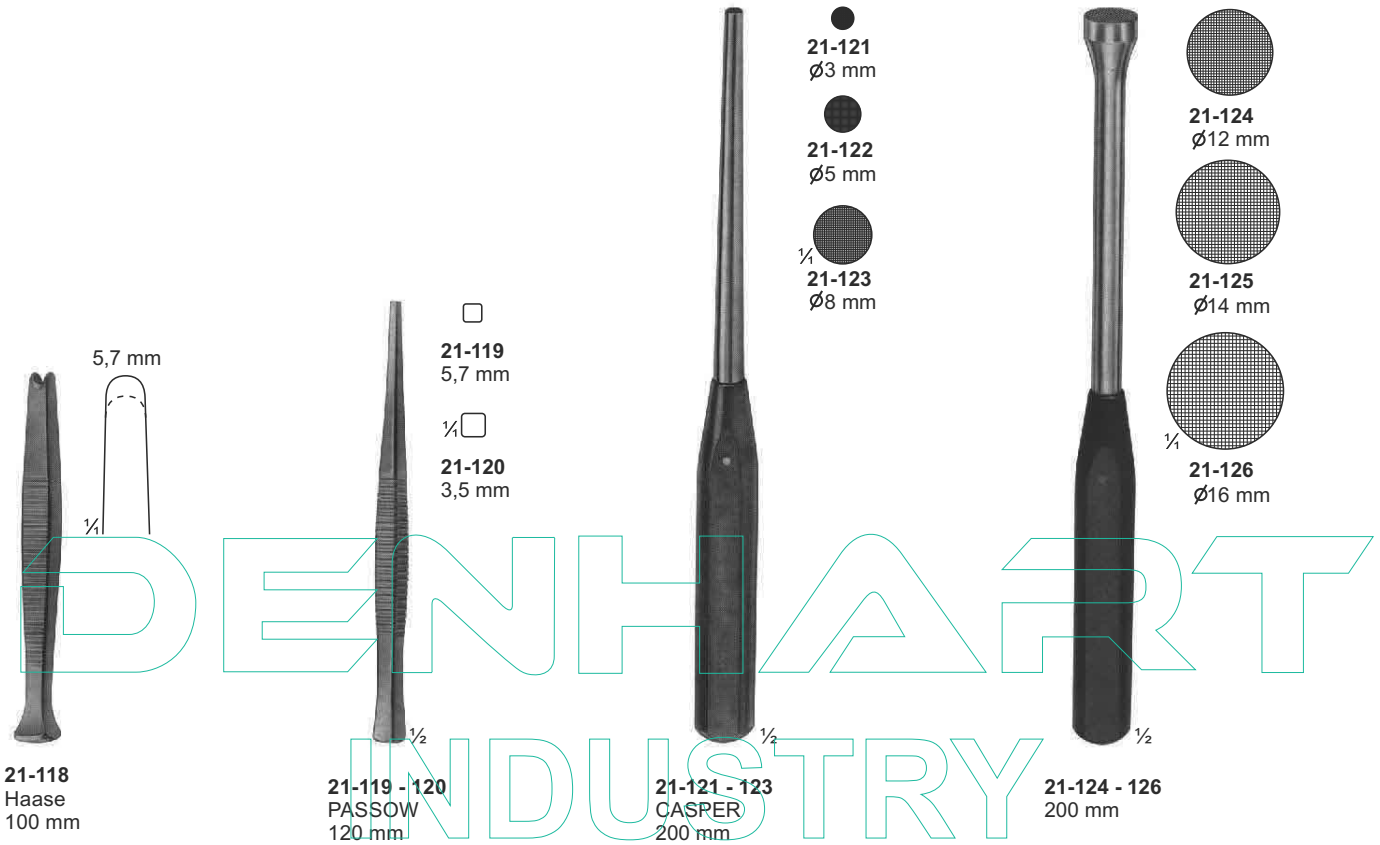

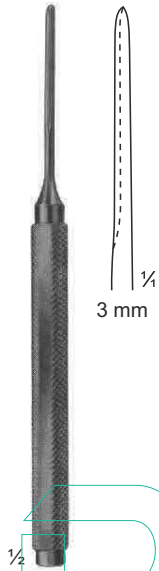

21-134
Mannerfelt
155 mm

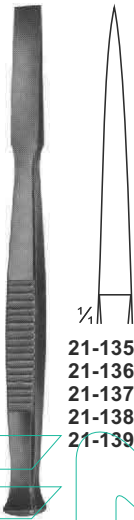

- 21-135** 4 mm
- 21-136** 6 mm
- 21-137** 8 mm
- 21-138** 10 mm
- 21-139** 12 mm

21-135 - 139
Osteotome
140 mm

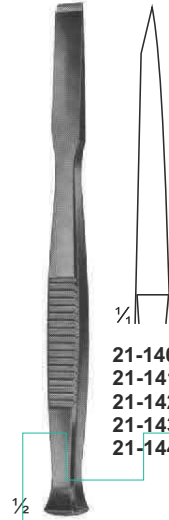

- 21-140** 4 mm
- 21-141** 6 mm
- 21-142** 8 mm
- 21-143** 10 mm
- 21-144** 12 mm

21-140 - 144
Chisels
140 mm

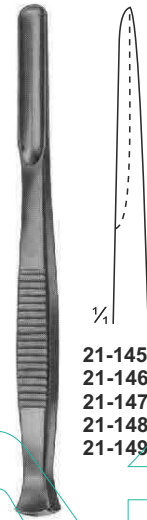

- 21-145** 4 mm
- 21-146** 6 mm
- 21-147** 8 mm
- 21-148** 10 mm
- 21-149** 12 mm

21-145 - 149
Gouges
140 mm

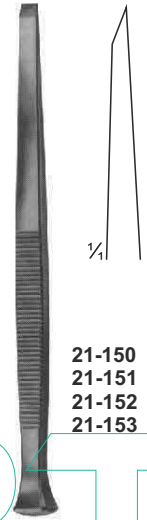

- 21-150** 3 mm
- 21-151** 4 mm
- 21-152** 5 mm
- 21-153** 6 mm

PARTSCH
21-150 - 153
Chisels
140 mm

INDUSTRY

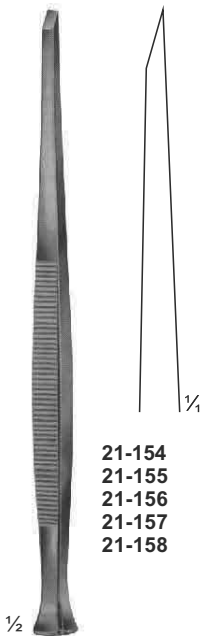

- 21-154** 3 mm
- 21-155** 4 mm
- 21-156** 5 mm
- 21-157** 6 mm
- 21-158** 7 mm

PARTSCH
21-154 - 158
Chisels
170 mm

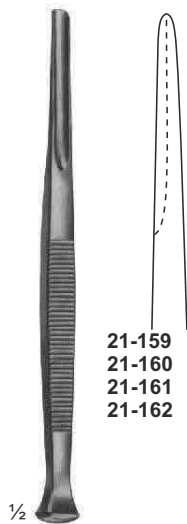

- 21-159** 3 mm
- 21-160** 4 mm
- 21-161** 5 mm
- 21-162** 6 mm

PARTSCH
21-159 - 162
Gouges
140 mm

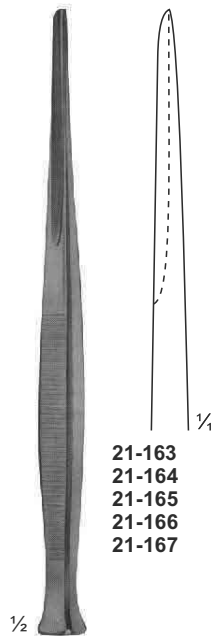

- 21-163** 3 mm
- 21-164** 4 mm
- 21-165** 5 mm
- 21-166** 6 mm
- 21-167** 7 mm

PARTSCH
21-163 - 167
Gouges
170 mm

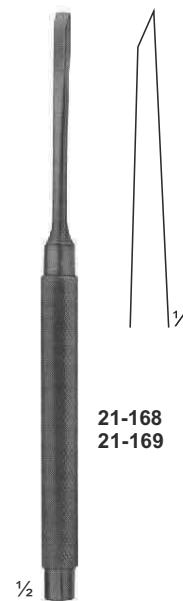

- 21-168** 4 mm
- 21-169** 6 mm

LUCAS
21-168 - 169
Chisels
160 mm

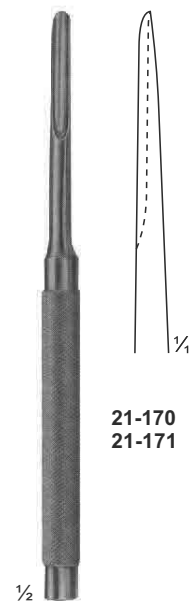

- 21-170** 3 mm
- 21-171** 5 mm

LUCAS
21-170 - 171
Gouges
160 mm

Osteotomes Chisels and Gouges



<p>21-172 5 mm 21-173 7 mm 21-174 9 mm 21-175 11 mm</p> <p>ALEXANDER 21-172 - 175 Gouges 170 mm</p>	<p>21-176 4 mm 21-177 6 mm 21-178 8 mm 21-179 10 mm 21-180 12 mm 21-181 15 mm</p> <p>LAMBOTTE 21-176 - 181 Osteotome 125 mm</p>	<p>21-182 4 mm 21-183 6 mm 21-184 8 mm 21-185 10 mm 21-186 12 mm</p> <p>COTTLE 21-182 - 186 Osteotome with depth markings 180 mm</p>	<p>21-187 4 mm 21-188 7 mm 21-189 9 mm 21-190 12 mm</p> <p>COTTLE 21-187 - 190 Chisel-Osteotomes with depth markings 180 mm</p>	<p>21-191</p> <p>COTTLE 21-191 Fishtail Chisel, with protected ends 180 mm</p>
<p>21-192 10 mm 21-193 12 mm 21-194 15 mm 21-195 20 mm 21-196 25 mm</p> <p>STILLE 21-192 - 196 Chisels 205 mm</p>	<p>21-197 10 mm 21-198 12 mm 21-199 15 mm 21-200 20 mm 21-201 25 mm</p> <p>STILLE 21-197 - 201 Gouges 205 mm</p>	<p>21-202 10 mm 21-203 15 mm</p> <p>WALTER 21-202 - 203 Osteotomes gouges for taking grafts from the rib 205 mm</p>	<p>21-204 8 mm 21-205 12 mm 21-206 15 mm 21-207 20 mm 21-208 25 mm</p> <p>STILLE 21-204 - 208 Osteotomes 205 mm</p>	

DENHART INDUSTRY

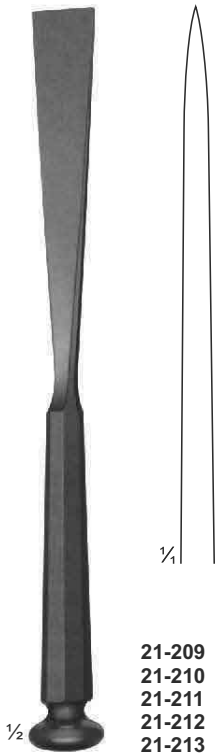

21-209	10 mm
21-210	12 mm
21-211	15 mm
21-212	20 mm
21-213	25 mm

STILLE
21-209 - 213
Osteotomes
205 mm

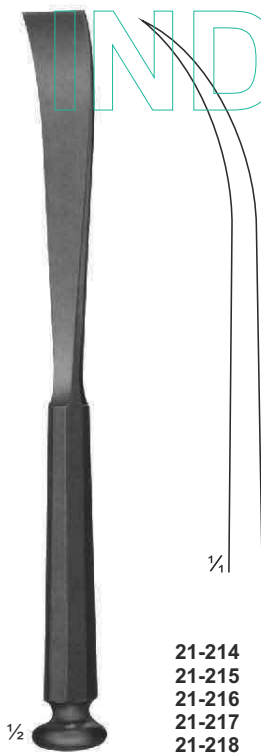

21-214	10 mm
21-215	12 mm
21-216	15 mm
21-217	20 mm
21-218	25 mm

STILLE
21-214 - 218
Osteotomes, curved
205 mm



21-219	4 mm
21-220	8 mm
21-221	10 mm
21-222	13 mm
21-223	15 mm
21-224	18 mm
21-225	20 mm
21-226	25 mm
21-227	30 mm
21-228	38 mm
21-229	44 mm
21-230	50 mm

LAMBOTTE
21-219 - 230
Osteotomes
245 mm

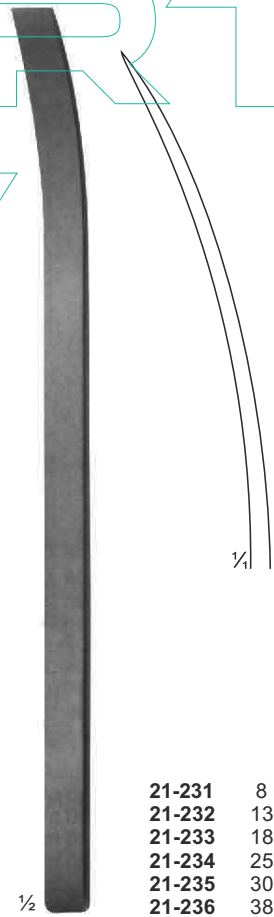

21-231	8 mm
21-232	13 mm
21-233	18 mm
21-234	25 mm
21-235	30 mm
21-236	38 mm

LAMBOTTE
21-231 - 236
Osteotomes, curved
245 mm

Osteotomes, Chisels and Gouges with HARTPRESS -handle

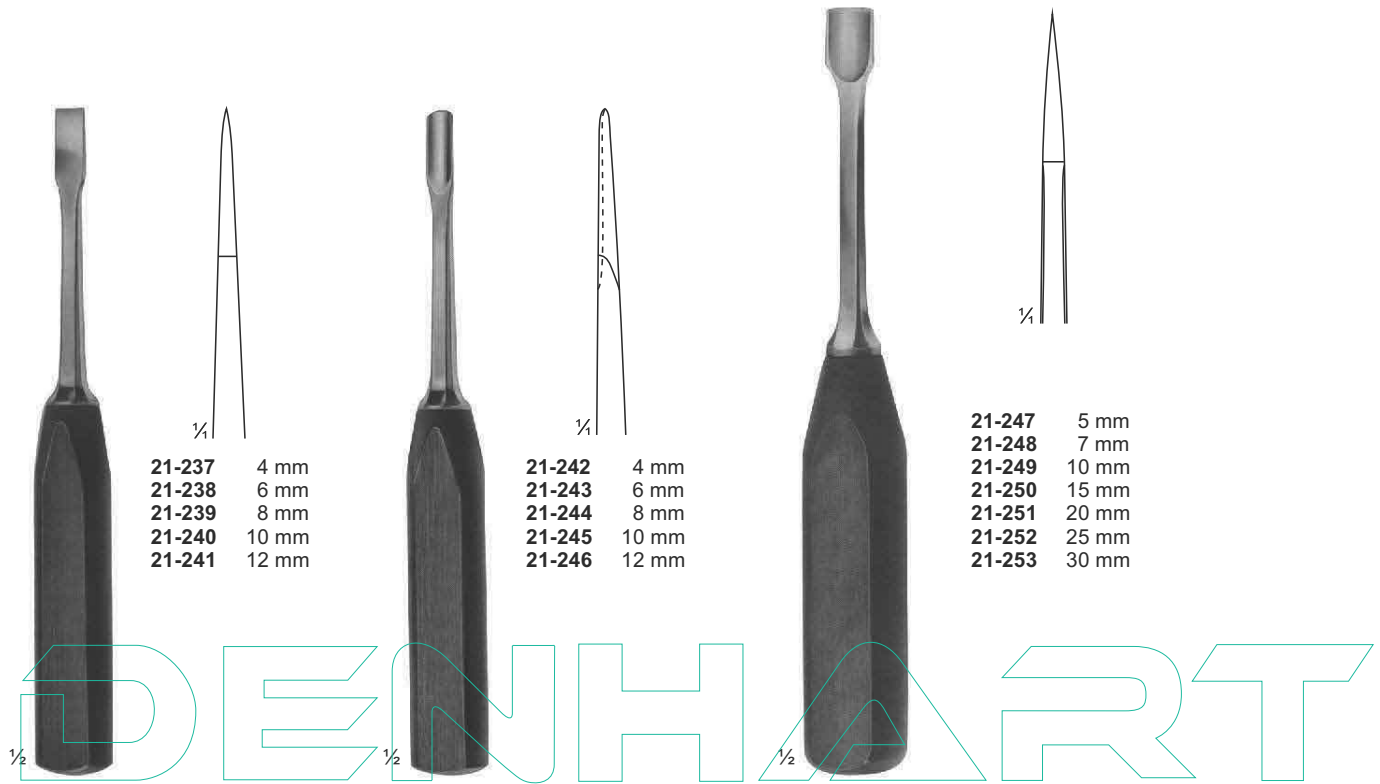

- 21-237 4 mm
- 21-238 6 mm
- 21-239 8 mm
- 21-240 10 mm
- 21-241 12 mm

- 21-242 4 mm
- 21-243 6 mm
- 21-244 8 mm
- 21-245 10 mm
- 21-246 12 mm

- 21-247 5 mm
- 21-248 7 mm
- 21-249 10 mm
- 21-250 15 mm
- 21-251 20 mm
- 21-252 25 mm
- 21-253 30 mm

LEXER-MINI
21-237 - 241
Osteotomes
180 mm

LEXER-MINI
21-242 - 246
Gouges
180 mm

LEXER
21-247 - 253
Osteotomes
220 mm



- 21-254 5 mm
- 21-255 7 mm
- 21-256 10 mm
- 21-257 15 mm
- 21-258 20 mm
- 21-259 25 mm
- 21-260 30 mm

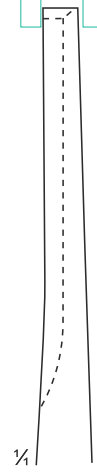

LEXER
21-261
Gouge for
removing broken
screws
220 mm



21-262 5,5 mm
21-263 9,0 mm

LEXER
21-254 - 260
Gouges
220 mm

ZIELKE
21-262 - 263
Gouge for
scoliose-operations
230 mm

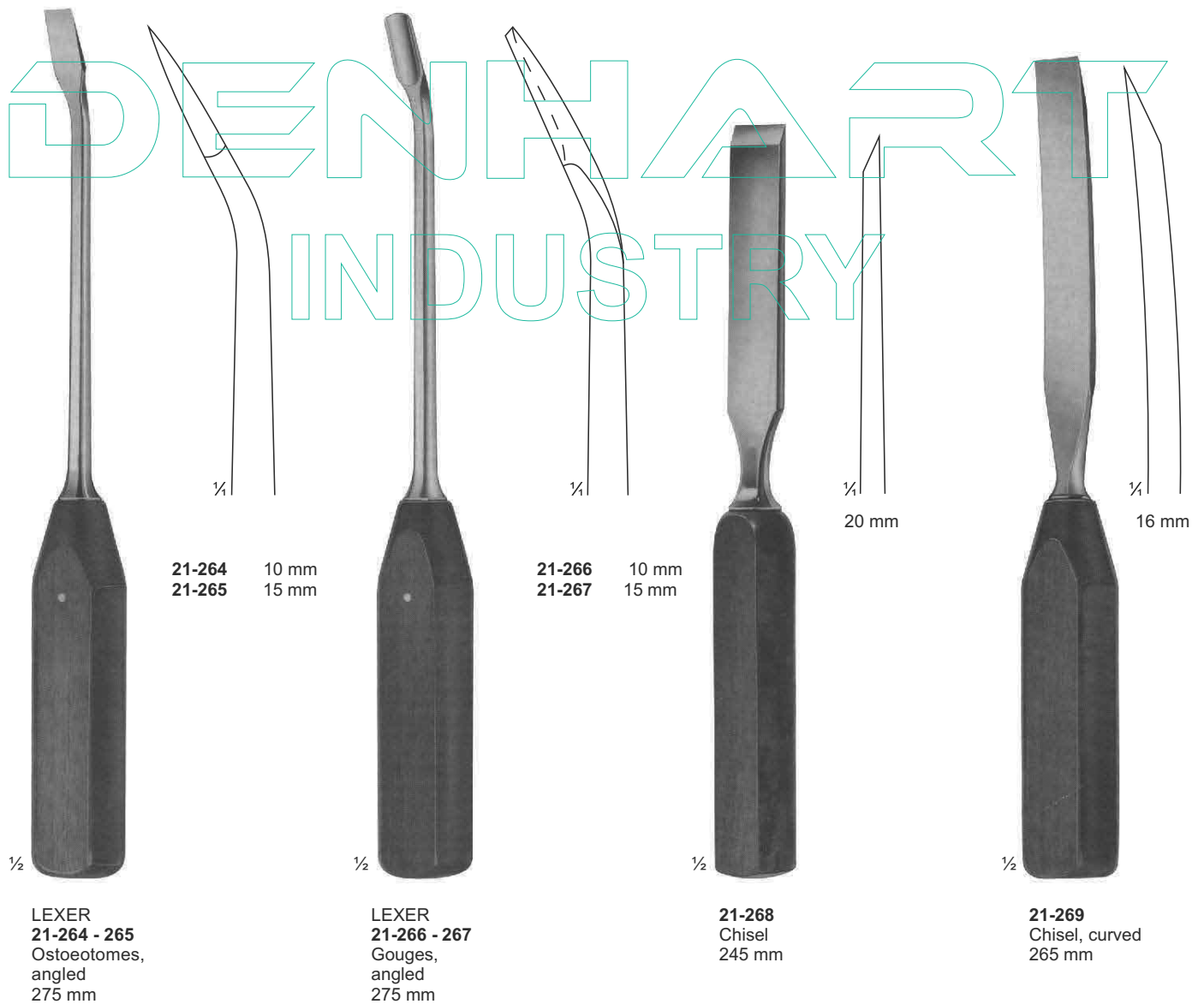

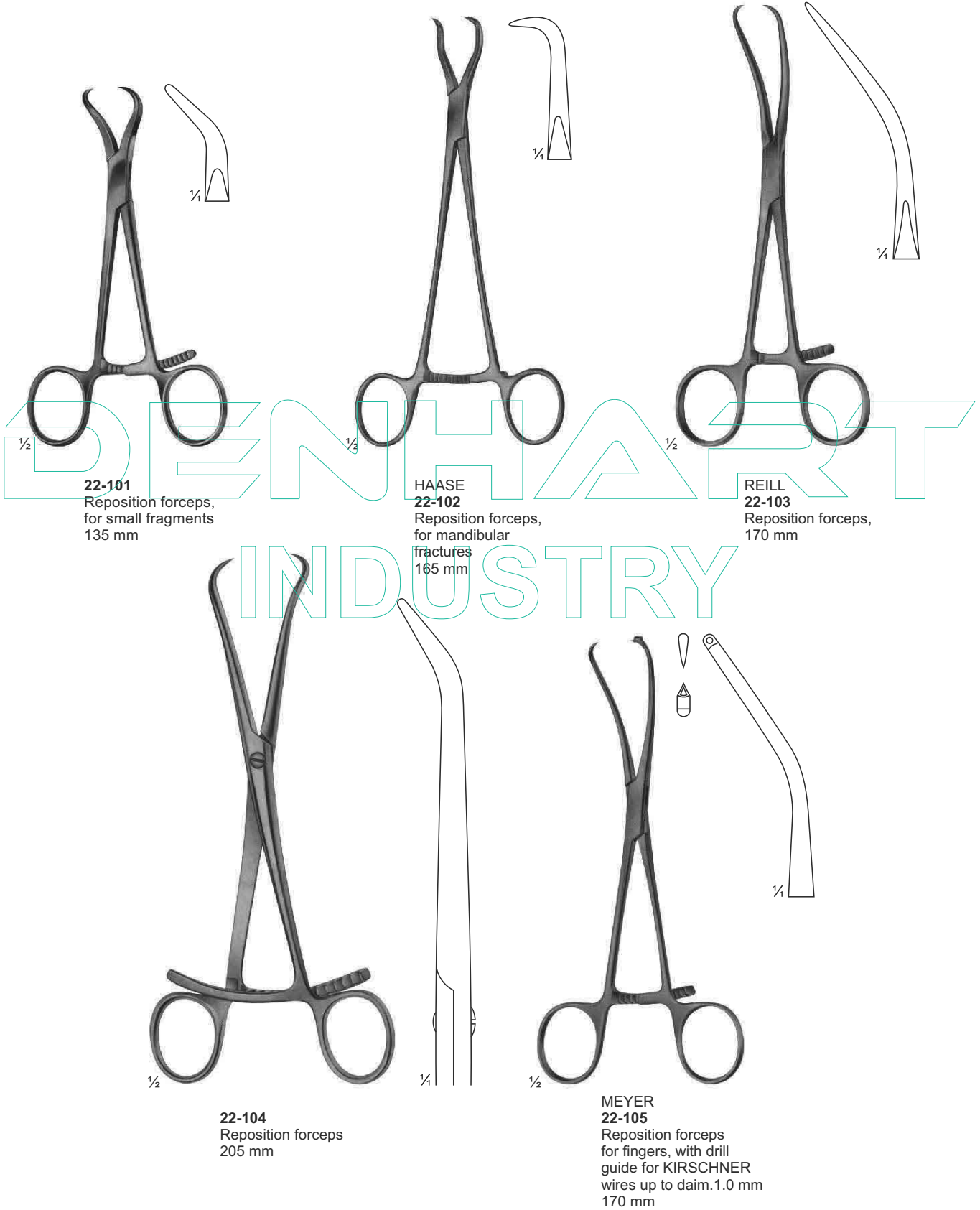

22-101
Reposition forceps,
for small fragments
135 mm

HAASE 22-102
Reposition forceps,
for mandibular
fractures
165 mm

REILL 22-103
Reposition forceps,
170 mm

22-104
Reposition forceps
205 mm

MEYER 22-105
Reposition forceps
for fingers, with drill
guide for KIRSCHNER
wires up to daim.1.0 mm
170 mm



22-106
Patella forceps
185 mm



22-107
Forceps with
ratchet fixation
140 mm

DENHART
INDUSTRY



22-108
Forceps with
thread fixation
170 mm



22-109
Forceps with
thread fixation
235 mm

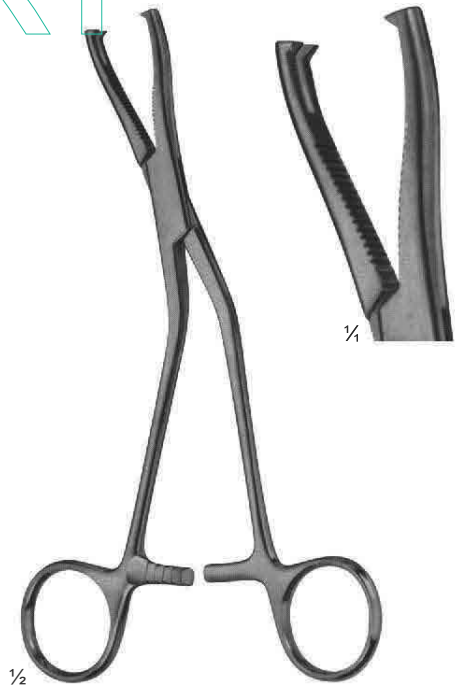

22-110
DINGMANN
185 mm

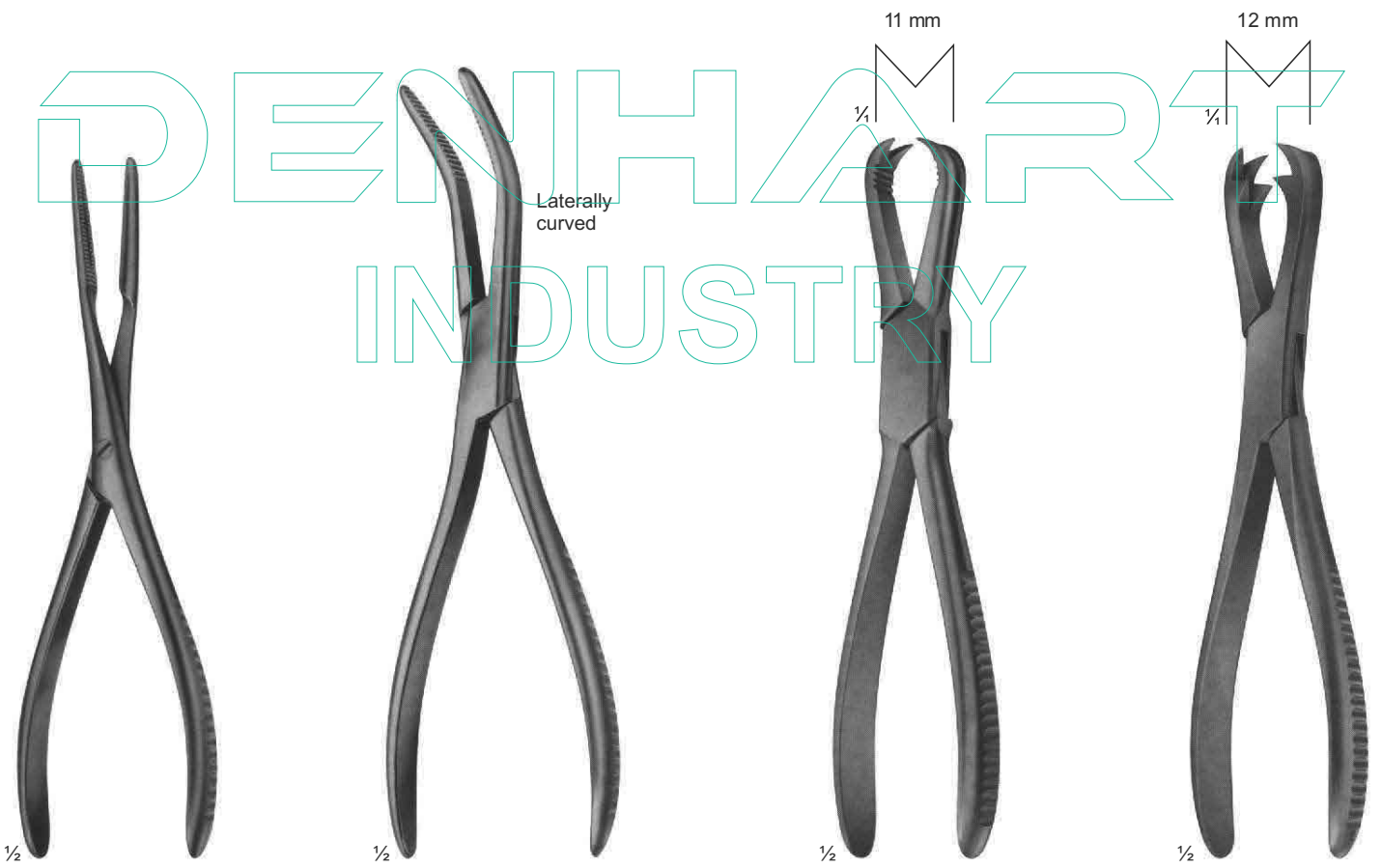

22-111
Sequestrum
forceps
200 mm

22-112
VAN BUREN
Sequestrum
forceps
225 mm

22-113
LANGENBECK
Sequestrum
forceps
205 mm

22-114
FERGUSSON
forceps
205 mm

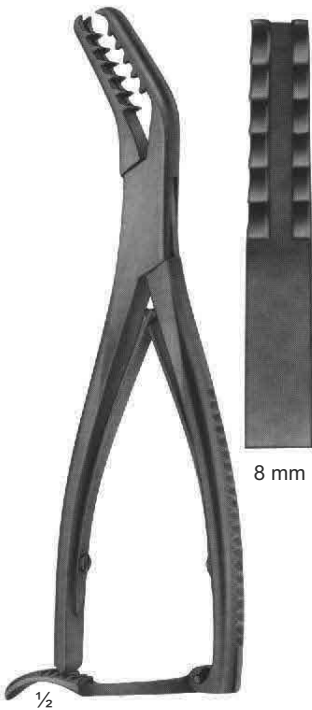
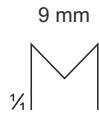
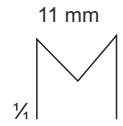
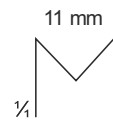
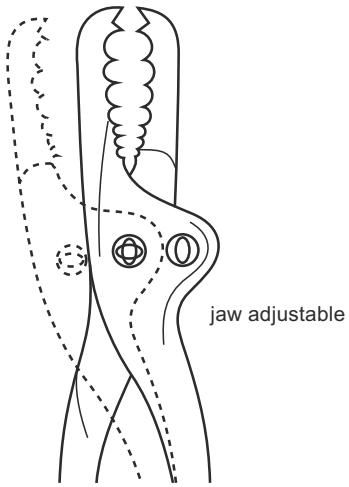

22-115
SEMB
190 mm



22-116
FARABEU
230 mm



22-117
FARABEU
255 mm



22-118
FARABEU-LAMBOTTE
255 mm

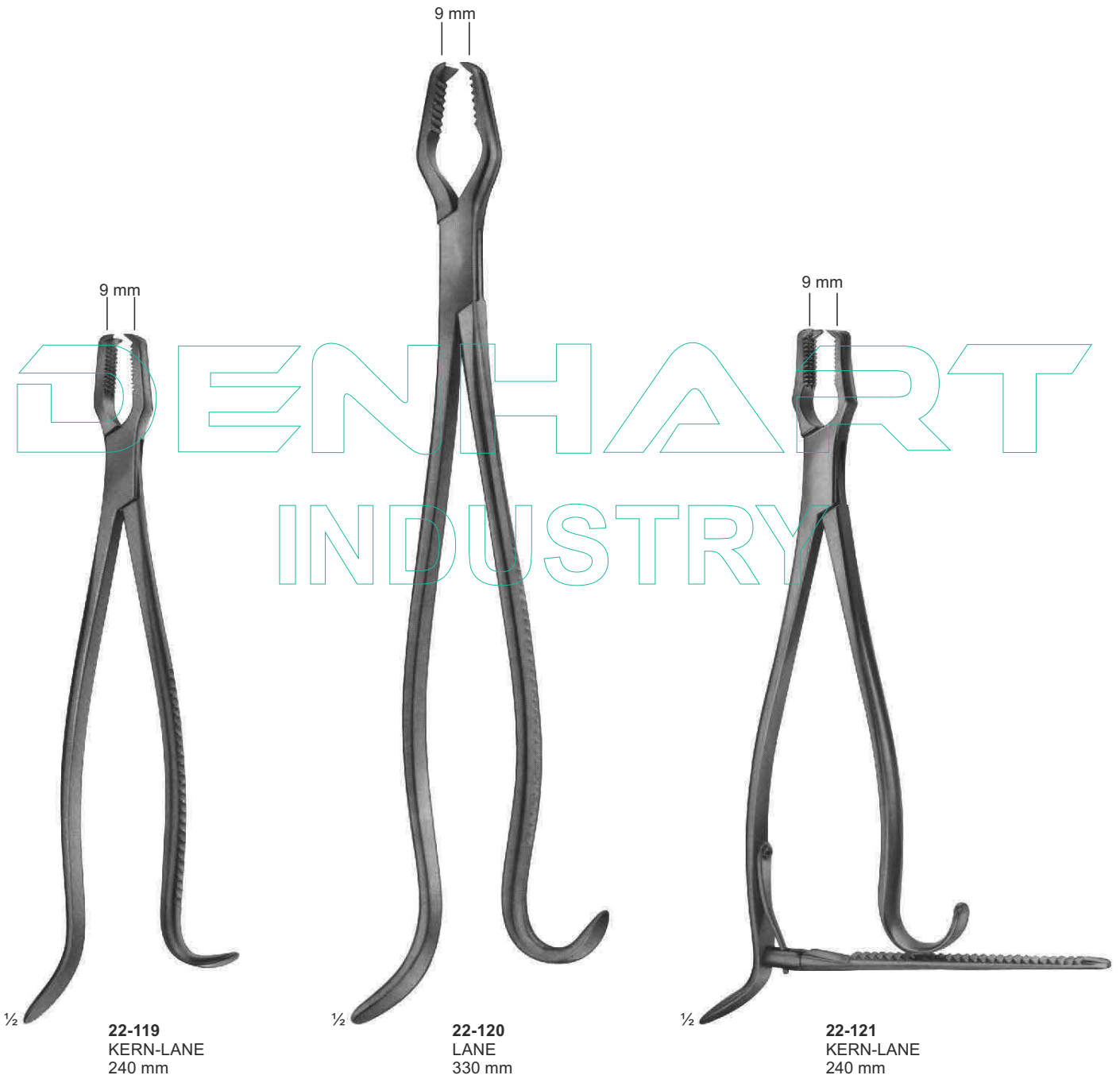

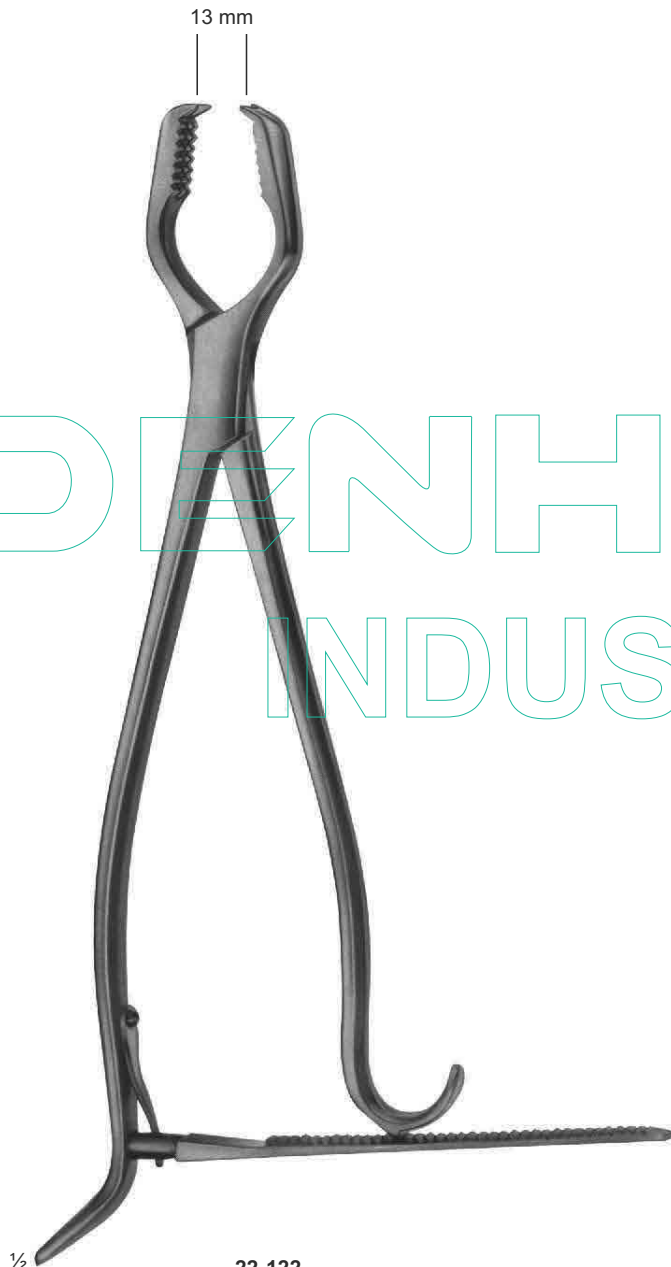

22-122
LANE
320 mm

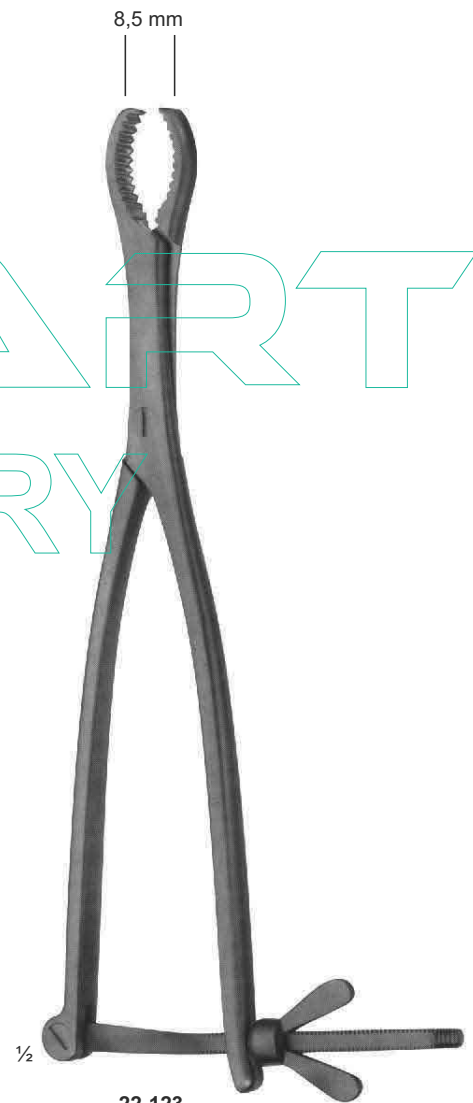

22-123
HEY GROVES
305 mm

DENHART
INDUSTRY

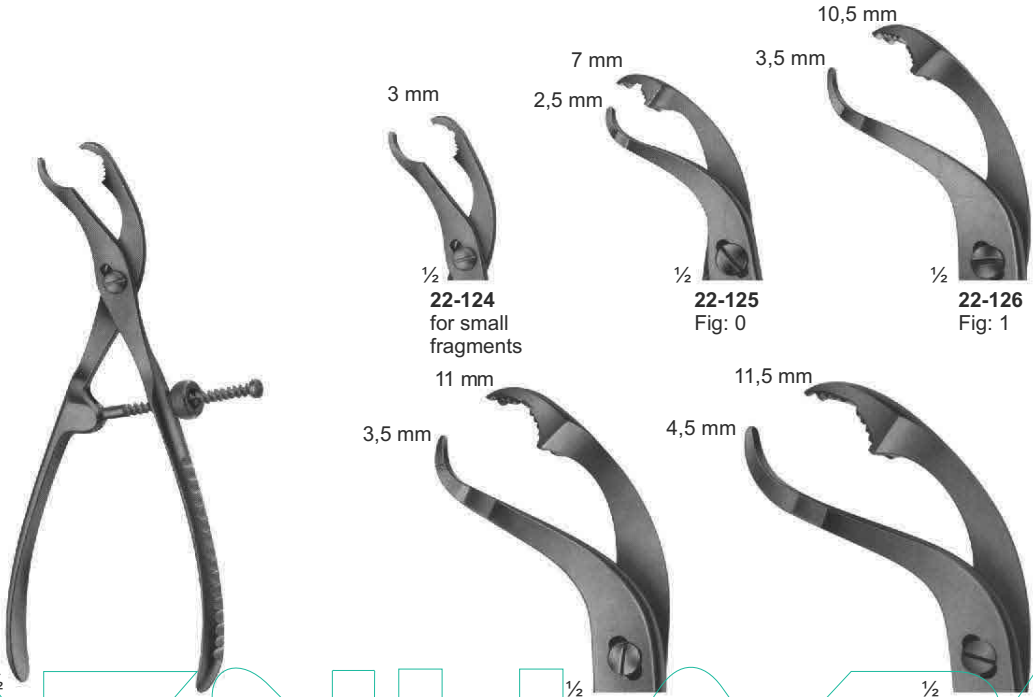

22-124 - 128
 22-124 145 mm
 22-125 190 mm
 22-126 240 mm
 22-127 260 mm
 22-128 280 mm

Self-centering forceps with thread fixation



22-129 - 131
 VERBRUGGE
 with lip joint
 255 mm
 265 mm
 270 mm

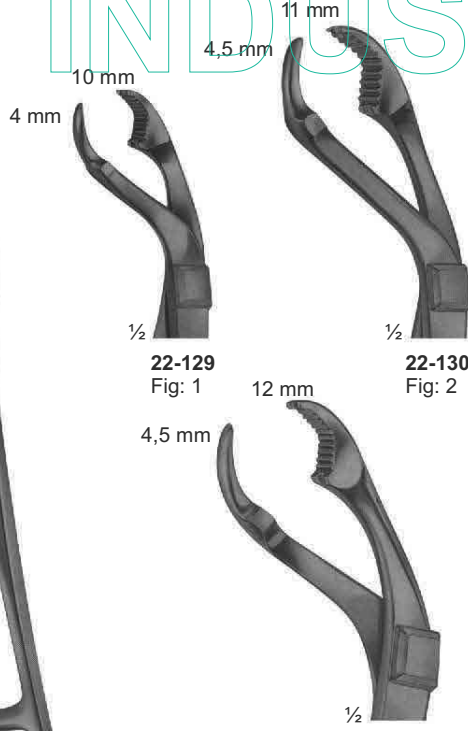

22-129 Fig: 1
22-130 Fig: 2
22-131 Fig: 3

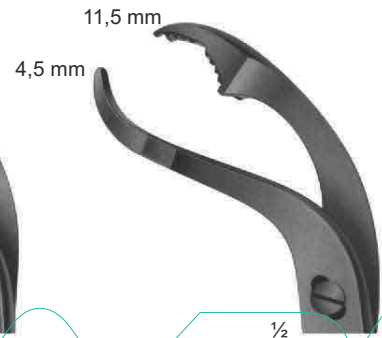

22-127 Fig: 2
22-128 Fig: 3



22-132
 LAMBOTTE
 265 mm

DENHART
INDUSTRY

DENHART INDUSTRY



1/2
22-133 - 134
LOWMAN
22-133 170 mm
22-134 205 mm



1/2
22-135
LOWMAN-GERSTER
210 mm



1/2
22-136
LOWMAN-HOGLUND
175 mm

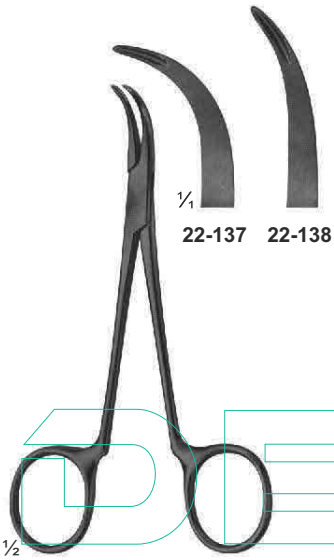

22-137 - 138
Synovectomy rongeur
width of jaws 1.2 mm
130 mm

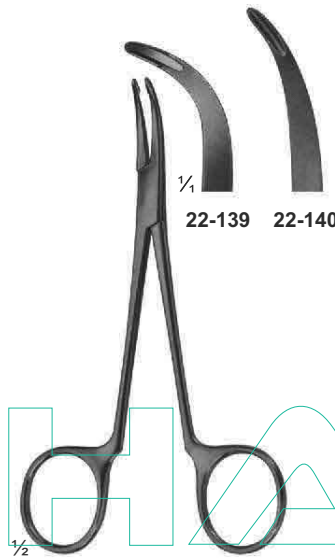

22-139 - 140
Synovectomy rongeur
width of jaws 2.0 mm
130 mm

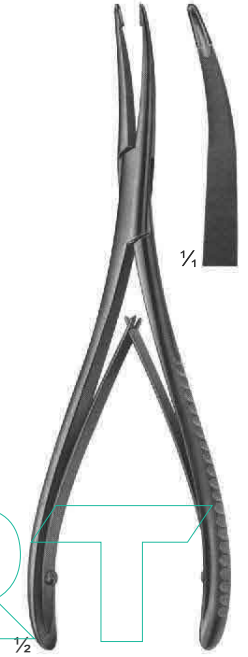

22-141
STELLBRINK
Synovectomy rongeur
175 mm

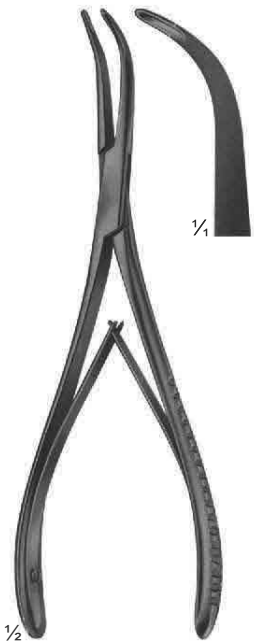

22-142
STELLBRINK
Synovectomy rongeur
170 mm



22-143
LURE-FRIEDMANN
145 mm

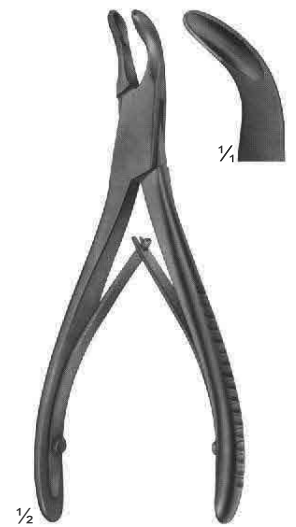

22-144
140 mm



22-145
LURE
150 mm

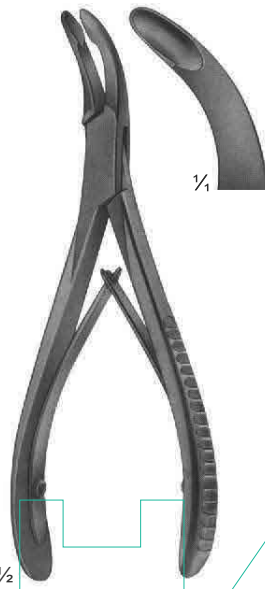

22-146
LURE
155 mm

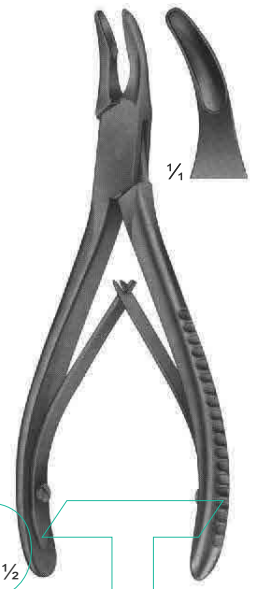

22-147
BLUMENTHAL
155 mm

DENHART
INDUSTRY



22-148
BLUMENTHAL
150 mm

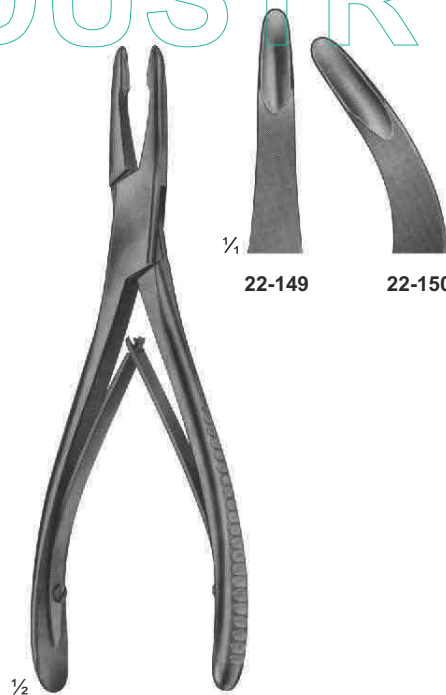

22-149 - 150
JANSEN
175 mm

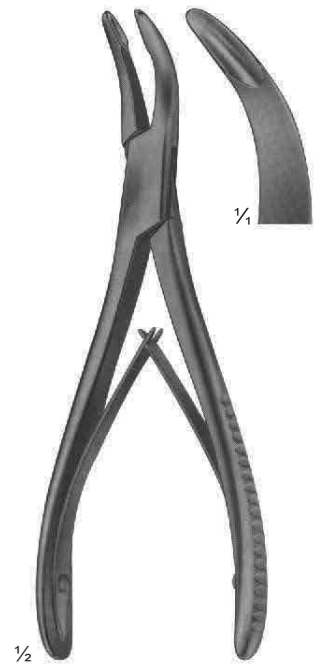

22-151
BANE-HARTMANN
175 mm

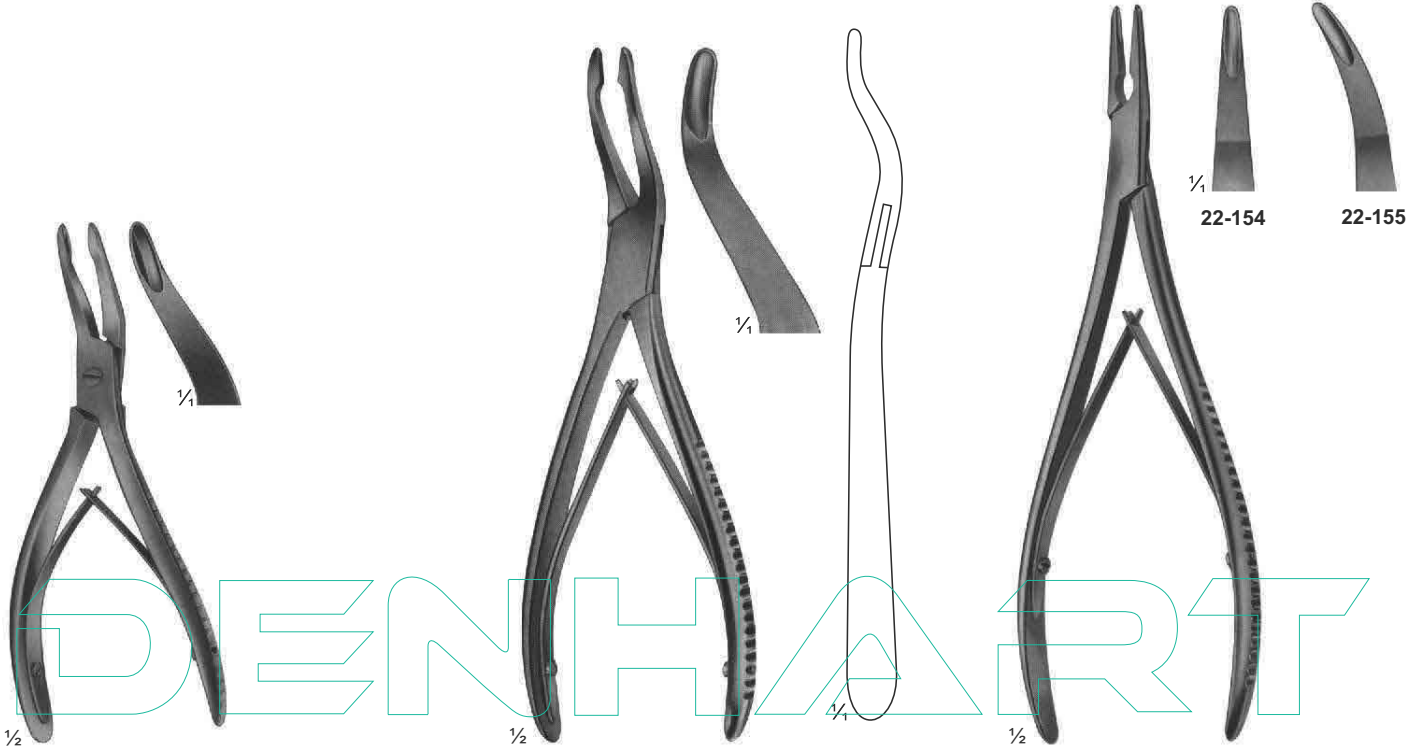

22-152
ALEXANDER
140 mm

22-153
JANSEN
190 mm

22-154 - 155
LEMPERT
200 mm

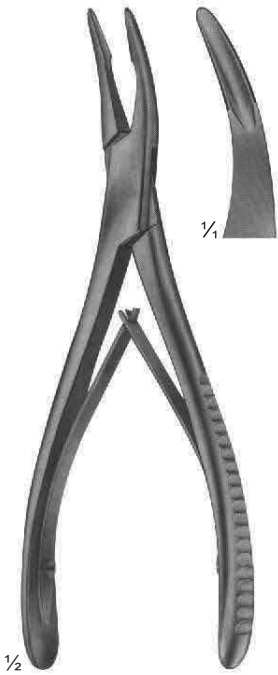

22-156
BEYER
180 mm

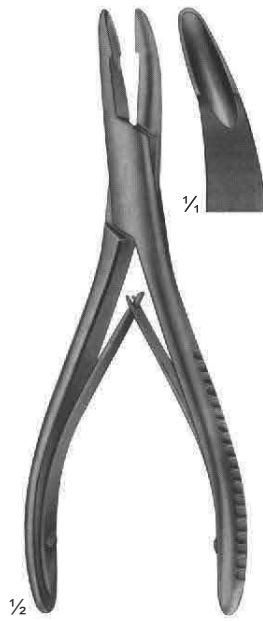

22-157
MEAD
165 mm

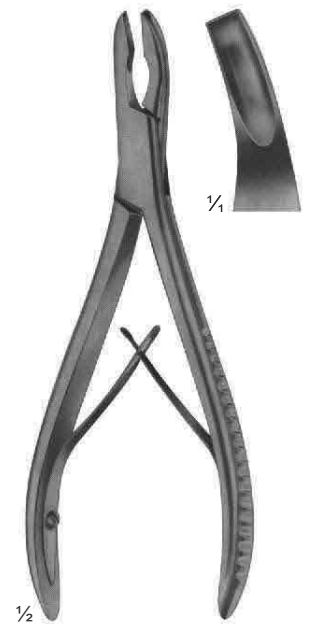

22-158
MEAD
165 mm

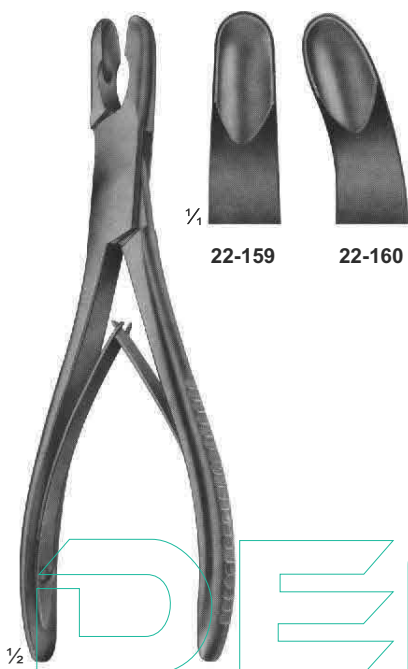

22-159 22-160

22-159 - 160
LURE
175 mm

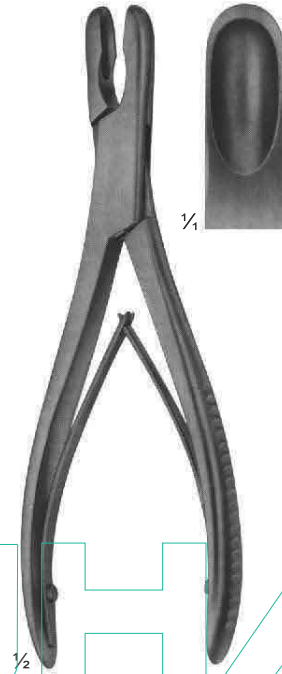

22-161
LURE
180 mm

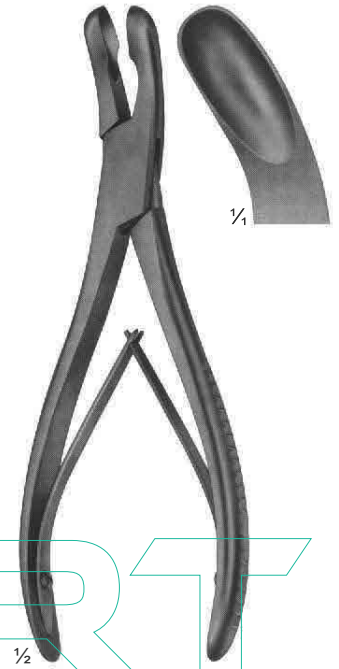

22-162
LURE
180 mm

DENHART
INDUSTRY

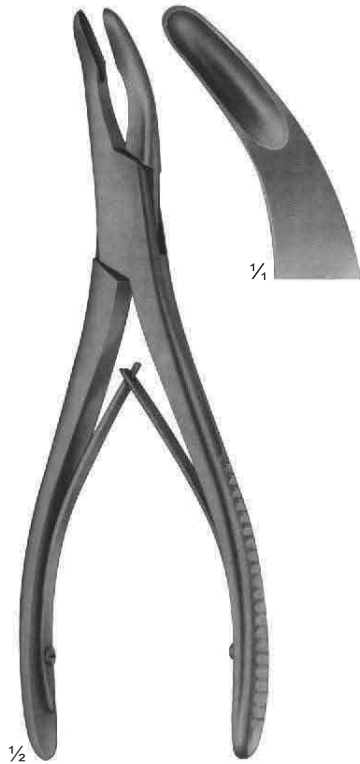

22-163
OLIVECRONA
205 mm



22-164 - 165
BOHLER
155 mm



22-166
MARQUARTD
200 mm

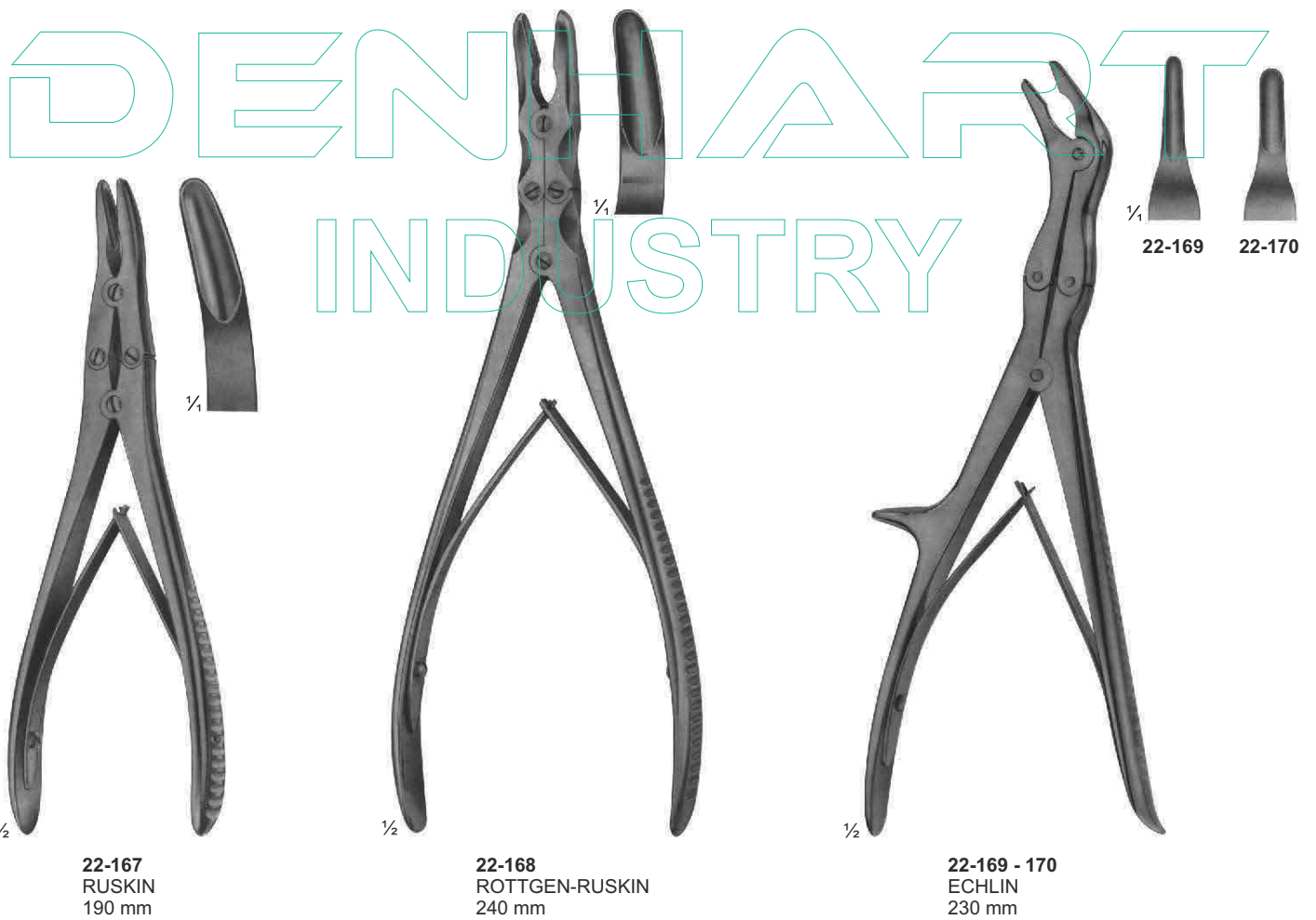

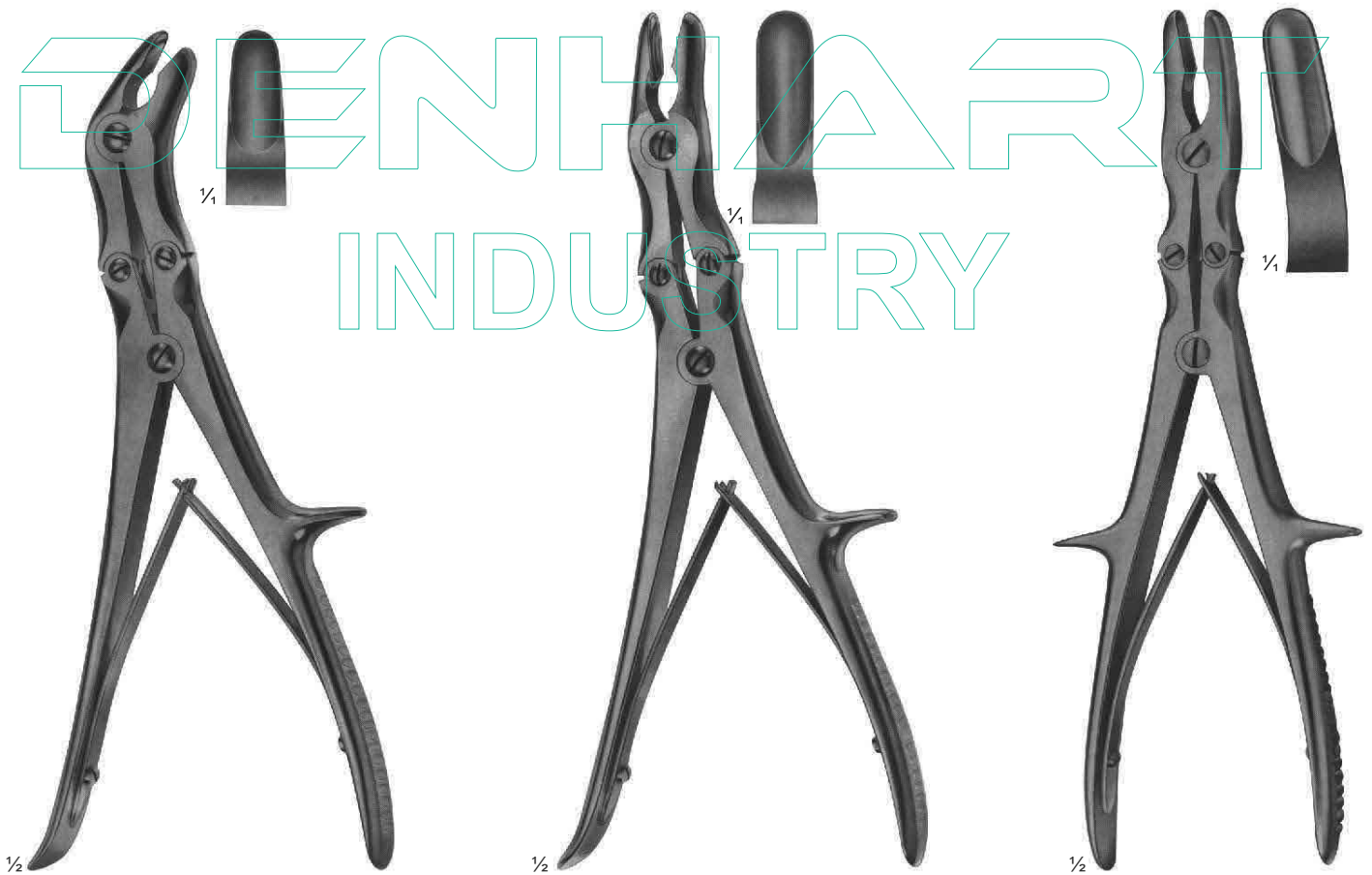

22-171
STILLE
235 mm

22-172
LEKSELL-STILLE
240mm

22-173
STILLE-RUSKIN
240mm

DENHART
INDUSTRY



22-174
LURE-STILLE
225 mm



22-175
LURE-STILLE
225 mm

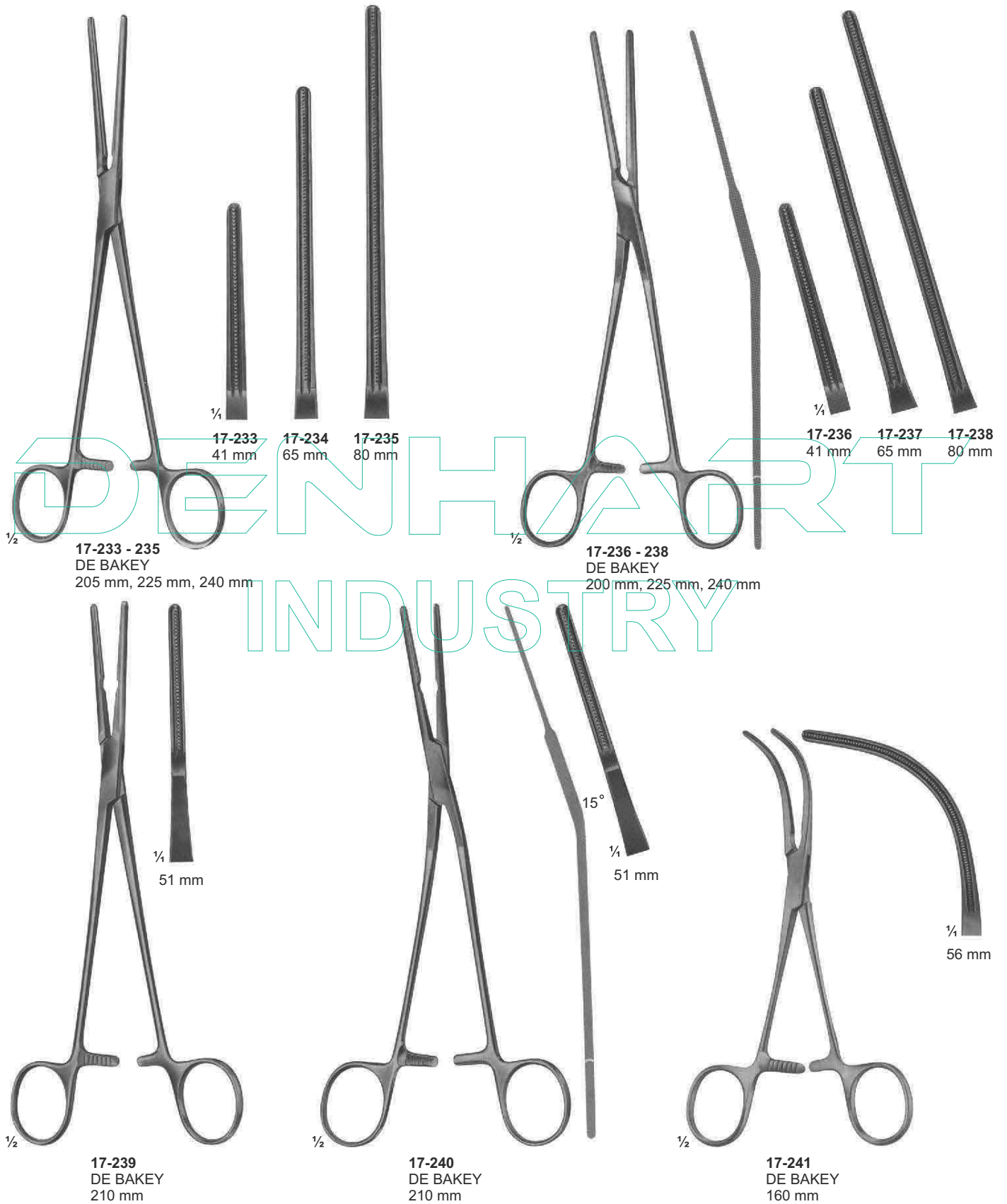

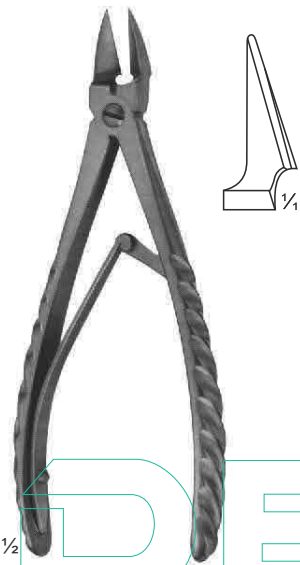

22-178
STAMM
150 mm

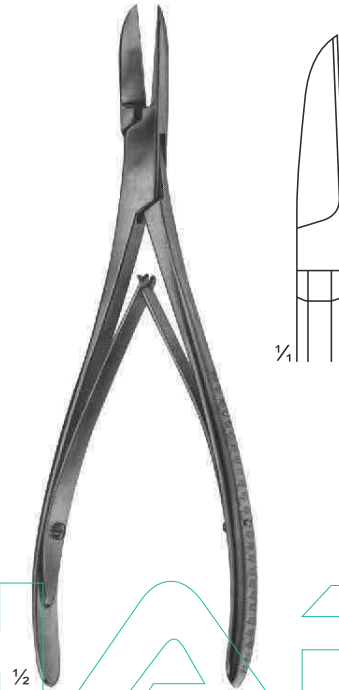

22-179
KAZANJIAN
185 mm



22-180
140 mm



22-181
170 mm



22-182
200 mm



22-183
220 mm

22-180 - 183
LISTON



22-184
170 mm

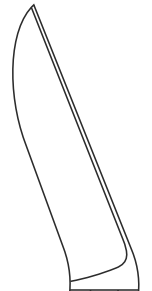

22-185
200 mm

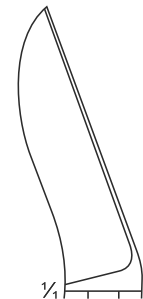

22-186
220 mm

22-184 - 186
LISTON

DENHART
INDUSTRY

DENHART INDUSTRY



22-187
BOHLER
145 mm



22-188
RUSKIN-LISTON
190 mm

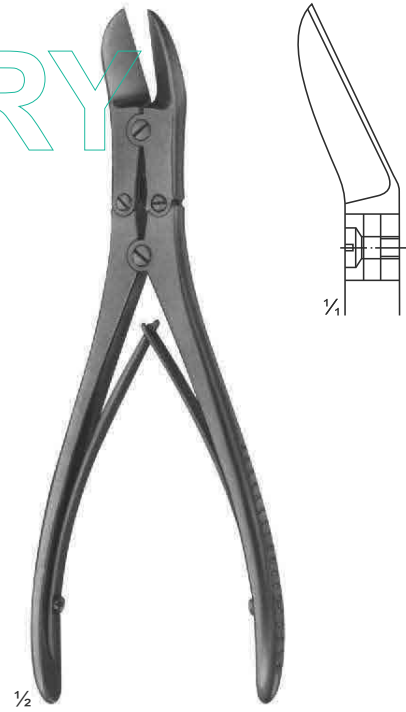

22-189
RUSKIN-LISTON
190 mm

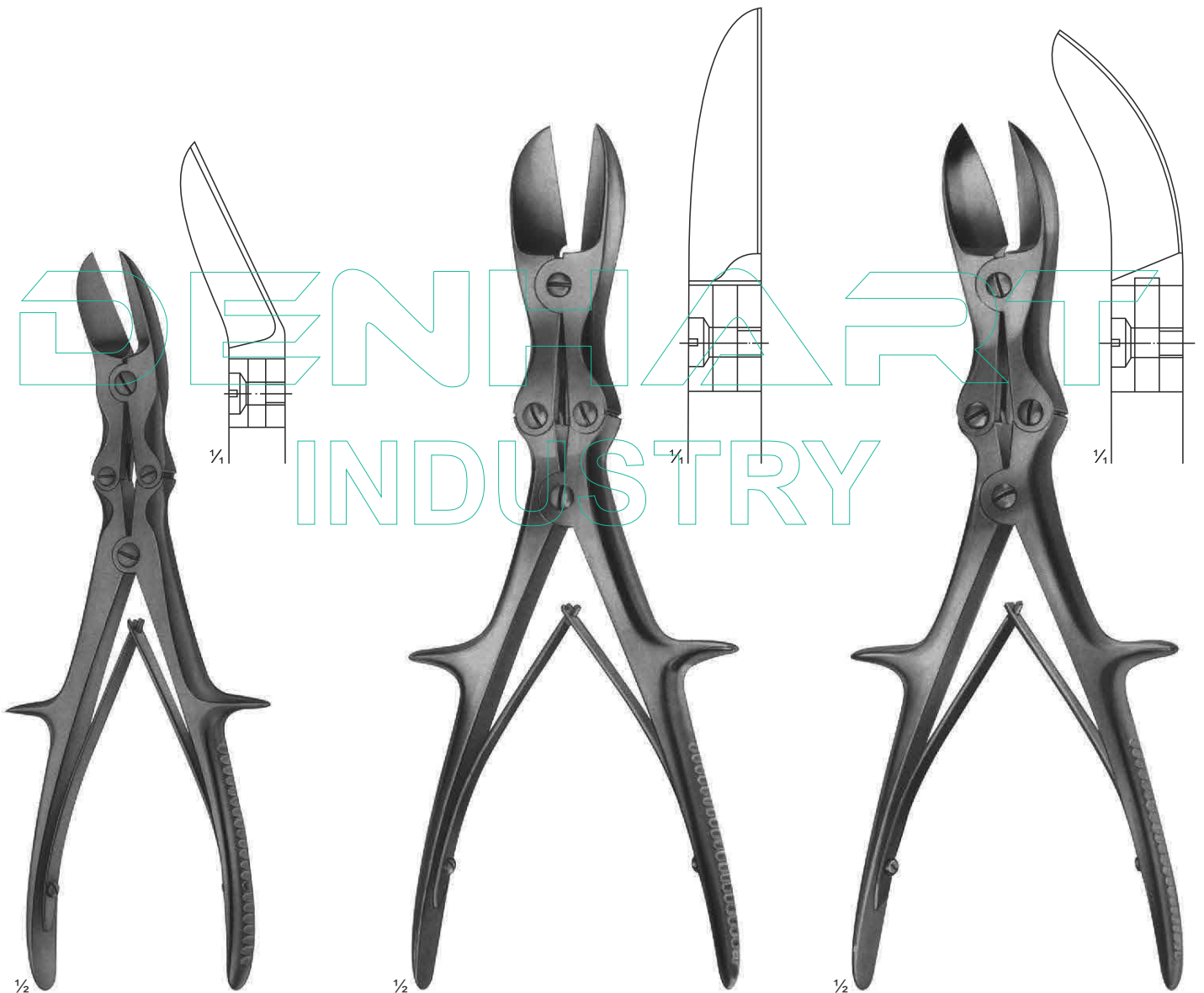

22-190
LISTON
curved on flat
240 mm

22-191
LISTON
straight
280 mm

22-192
LISTON
curved on flat
280 mm

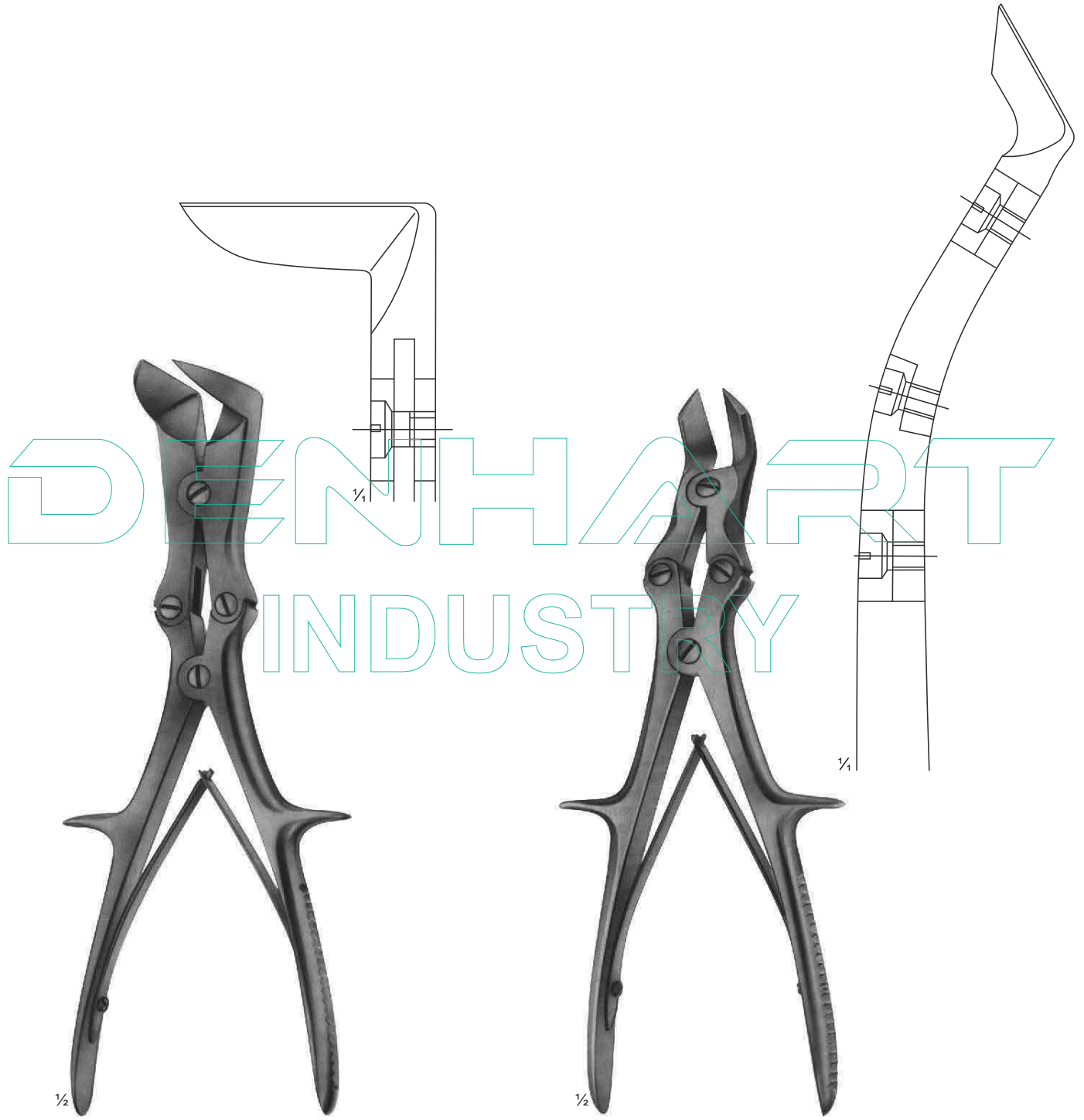

22-193
LISTON-STILLE
265 mm

22-194
LISTON-KEY-HORSLEY
(TUDOR EDWARDS)
255 mm

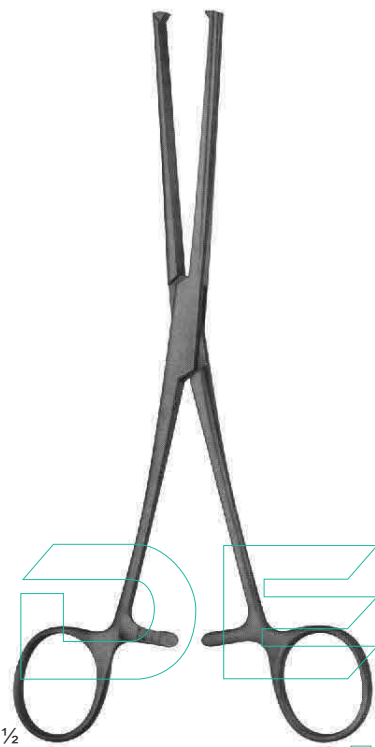

22-195
BIRCHER
200 mm



22-196
BIRCHER
200 mm

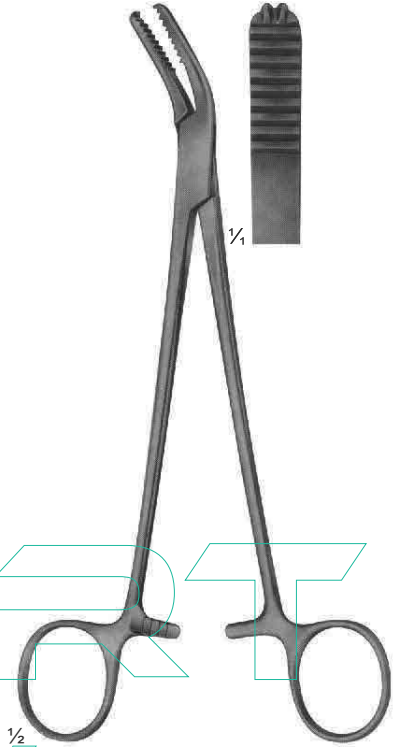

22-197
WELLER
200 mm

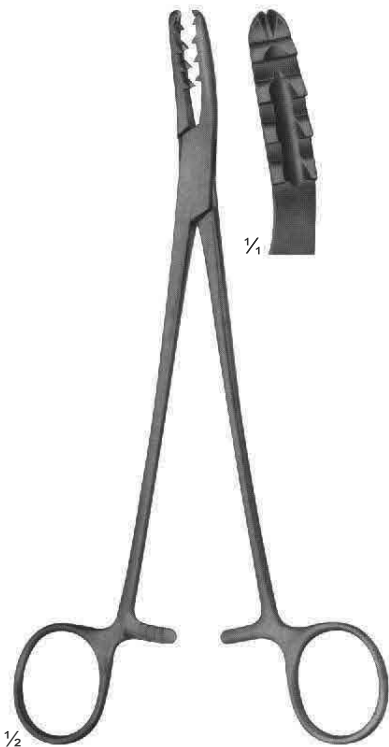

22-198
BIRCHER-GANSKE
200 mm

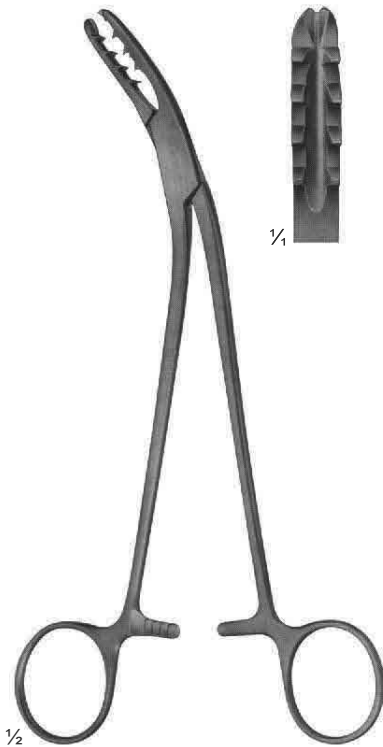

22-199
BIRCHER-GANSKE
200 mm



22-200
MARTIN
205 mm



DENHART INDUSTRY

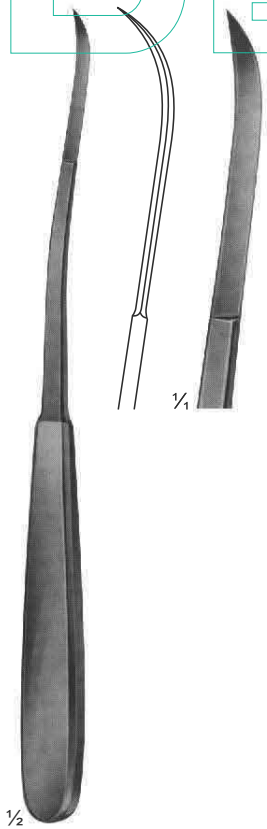

22-205
SALENIUS
220 mm

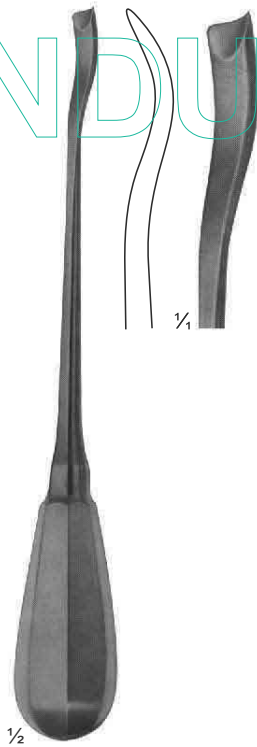

22-206
CHNAD.MODELL
200 mm

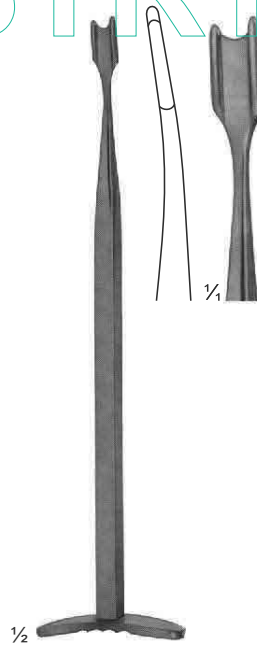

22-207
SMILLIE
170 mm

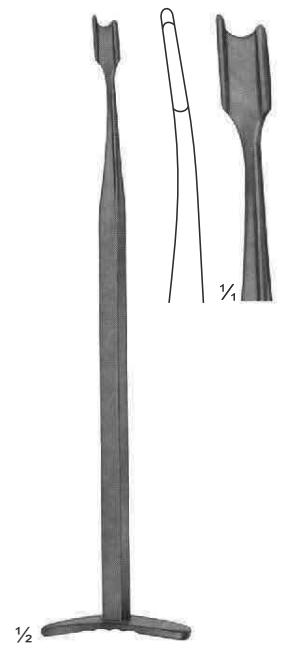

22-208
SMILLIE
170 mm

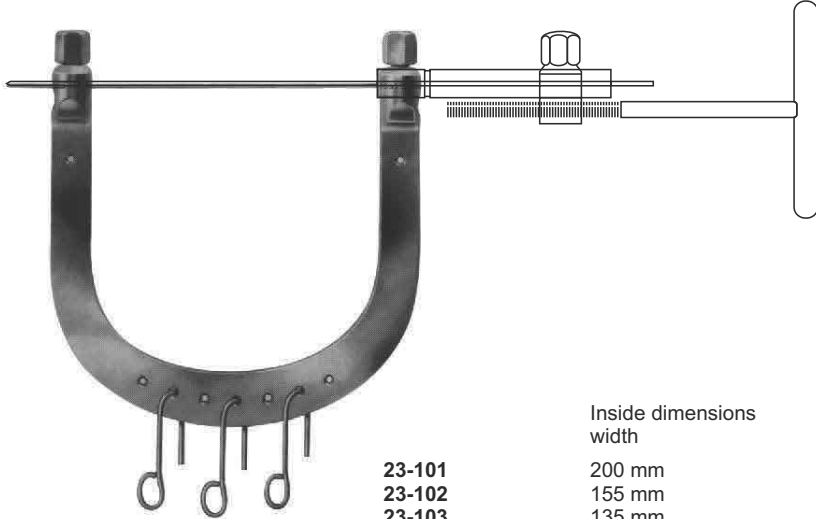

23-101 - 107
KIRSCHNER
Wire traction bows,
to be used with
KIRSCHNER-wires
up to 2.5 mm diam.,
With 3 hooks,
stainless steel

	Inside dimensions width	depth
23-101	200 mm	155 mm
23-102	155 mm	155 mm
23-103	135 mm	130 mm
23-104	120 mm	120 mm
23-105	105 mm	100 mm
23-106	95 mm	110 mm
23-107	95 mm	70 mm

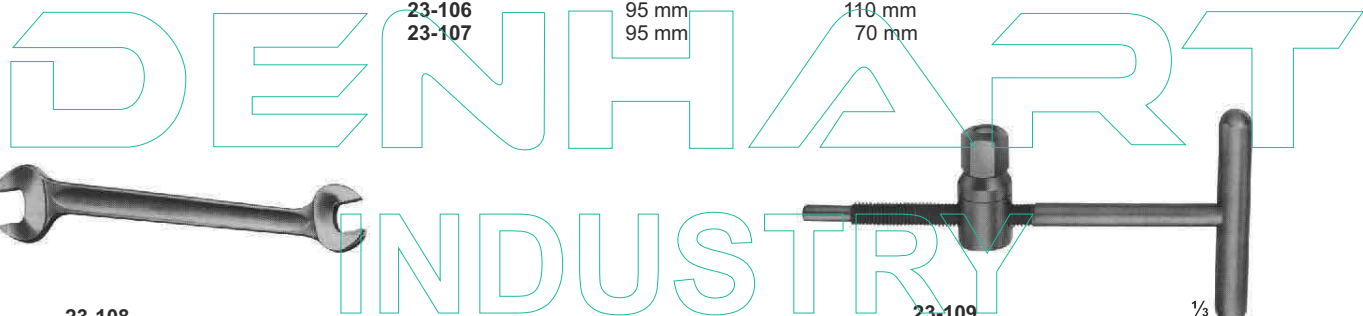

23-108
Wrench, double - ended,
for wire traction bows

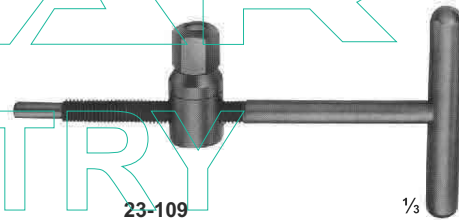

23-109
Wire tightener, with
clamping jaws



23-110
Traction hook only,
large size



23-111
Traction hook only,
small size



23-112
Fixation clamp, to secure clamping
jaws of stainless steel

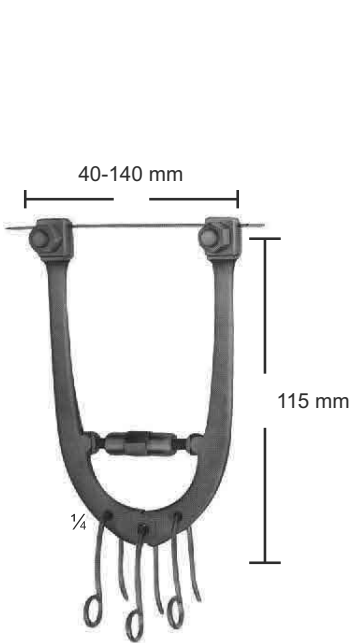

23-113
Wire traction bow, adjustable,
with 3 hooks, small size

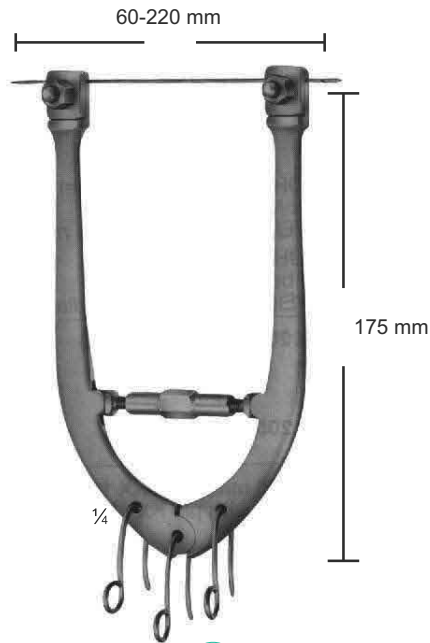

23-114
Wire traction bow, adjustable,
with 3 hooks, large size

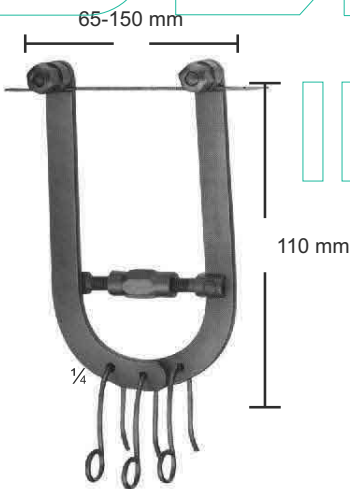

23-115
Wire traction bow, adjustable,
with 3 hooks, large size for
elbow and calcaneus, for
adolescents



23-116 105 mm
23-117 160 mm
23-118 200 mm

23-116 1,6 mm
23-117 2,0 mm
23-118 2,5 mm

23-116 - 118
KIRSCHNER
Wire traction bow, modified
adjustable in with width, holds wire
securely, with 1 hook



23-119
Fixation disc, slotted



23-121
Fixation disc, slotted



23-120
idem, aluminum, transparent
to X-rays



23-122
Screw driver, for above
fixations discs

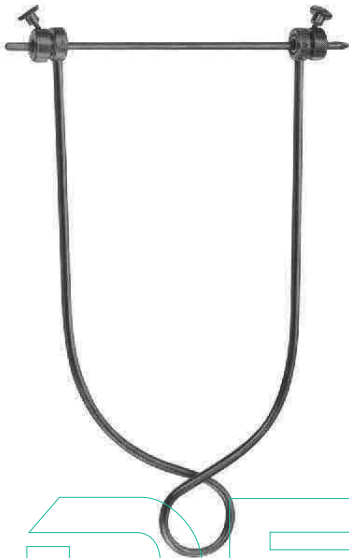

Steinmann pins, 4 mm daim.		Steinmann pins, 5 mm daim.	
23-123	with pin		16x9cm Arm
23-124	without pin	23-129	without
23-125	with pin		21x11cm Arm
23-126	without pin	23-130	without
23-127	with pin		21x15cm Arm
23-128	without pin		

23-123 - 130
Screw driver, for above fixations discs

DENHART

INDUSTRY



23-131
SCHWARZ
Traction bow for fingers,
to be used with KIRSCHNER-
wire up to 1.6 mm diam.

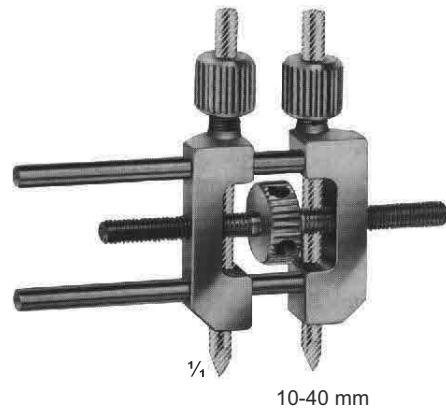

23-132
Small distractor
as a repositioning device for
distraction and compression of small bones,
for wires with 3.0 mm diam.



DENHART

INDUSTRY

23-133 - 147
STEINMANN
 triangular shaft ended and trocar point

Length	4,0 mm	5,0 mm
80 mm	23-133	
100 mm	23-134	
120 mm	23-135	
140 mm	23-136	
150 mm	23-137	23-143
160 mm	23-138	
180 mm	23-139	23-144
200 mm	23-140	23-145
210 mm	23-141	
250 mm	23-142	23-146
300 mm		23-147



$\frac{1}{4}$
23-148
 Protection cap
 for 4,0 mm STEINMANN Pins



$\frac{1}{4}$
23-149
 Protection cap
 for 5,0 mm STEINMANN Pins



1/2

23-150
REILL
Drilling chuck, cannulated, for shanks from 2.0 - 2.5 mm diam 115 mm



1/2

23-151
Drilling chuck, cannulated, for shanks from 0.8 - 2.0 mm diam 150 mm



1/2

23-152
Drilling chuck, cannulated, for shanks up to 4.5 mm diam with key 140 mm



1/2

23-153
LOUTE
Wire tightener, improved pattern, with movable tip, for wires up to 1.0 mm diam. 220 mm



1/2

23-154
Drilling chuck, cannulated, for shanks up to 6.35 mm diam., To be tightened by hand 100 mm



1/2

23-155
Drilling chuck, cannulated, for shanks up to 4.5 mm diam., And for triangular shaft width across flats 4.7 mm



1/2

23-156
Drilling chuck, cannulated, for shanks up to 6.35 mm diam., With key 160 mm

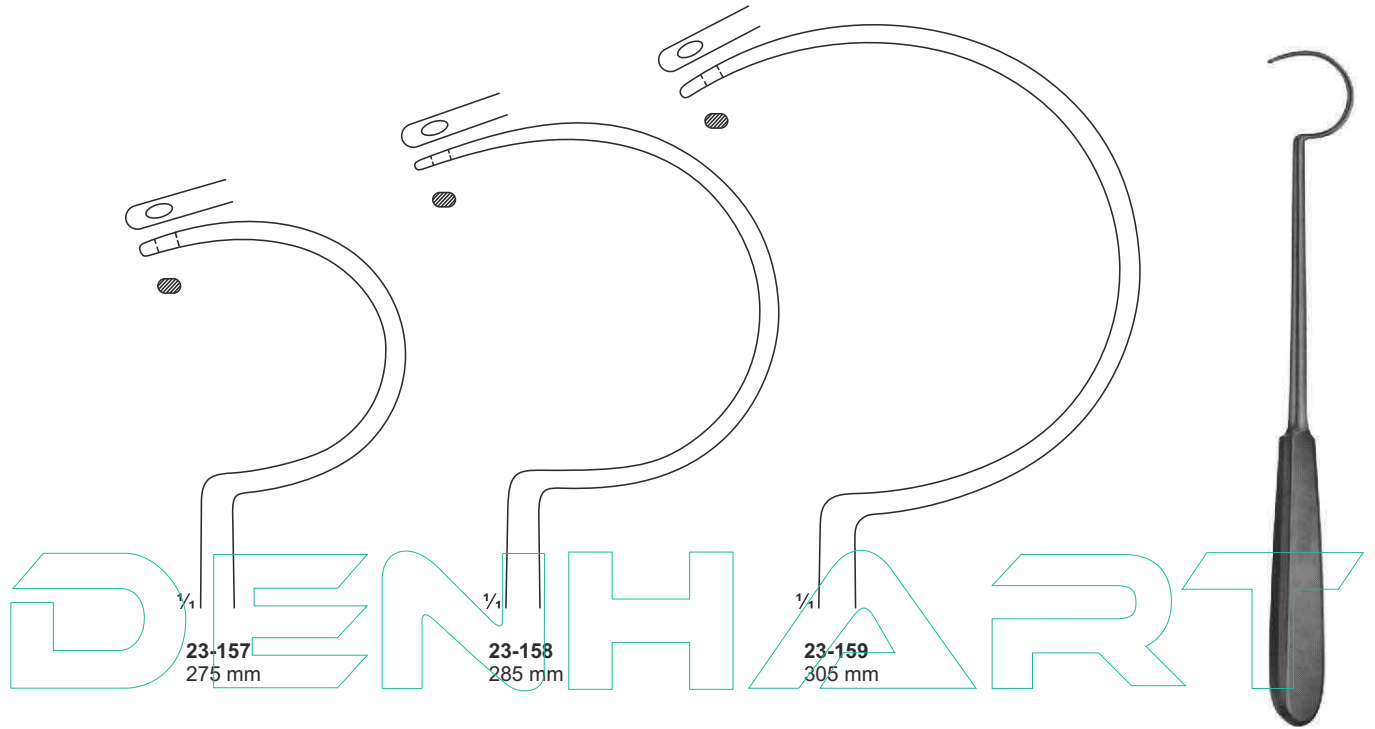

23-157
275 mm

23-158
285 mm

23-159
305 mm

23-157 - 159
DEMEL
Wire guides

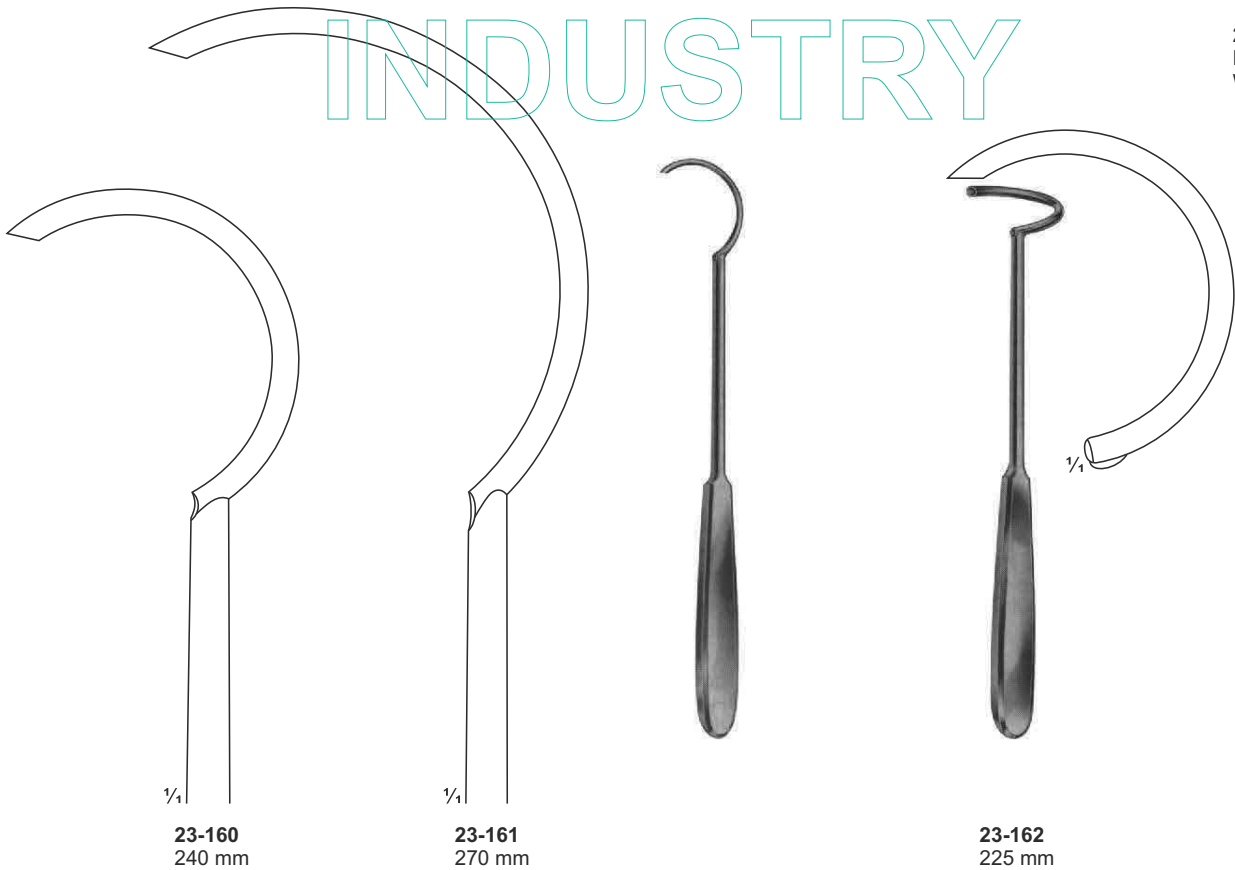

23-160
240 mm

23-161
270 mm

23-162
225 mm

DENHART INDUSTRY



23-163
JORDAN
Wire tightener



1/2

23-164
JORDAN
Wire twister
170 mm



1/2

23-165
JORDAN
Wire catcher
180 mm



1/2

23-166
JORDAN
Probe, cannulated
170 mm

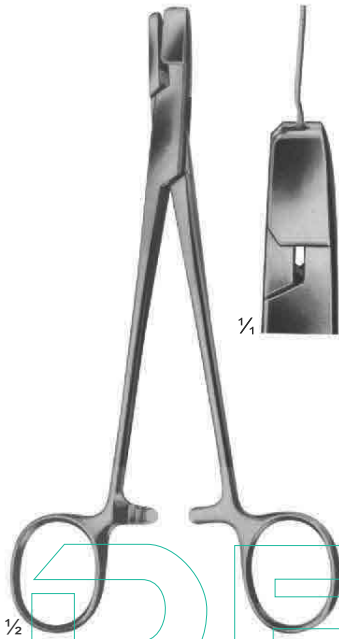

23-167
DUROGRIP
Holding forceps for cerclage
wire, with lateral jaws to avoid
wire slipping off
170 mm



23-168
DUROGRIP
Wire, tightening pliers,
Ligature pliers
150 mm



23-169
DUROGRIP
Wire, tightening pliers,
Ligature pliers
150 mm



23-170
with serrated jaws
140 mm



23-171
one jaws smooth,
one jaws serrated
140 mm



23-172
with serrated jaws
23-173
with longitudinal and
transversal grooves
170 mm



23-174
190 mm

Wire Holding forceps, Flat-nosed Pliers, Pliers for bending and cutting wires



23-175 - 176
Extraction pliers for boring wires

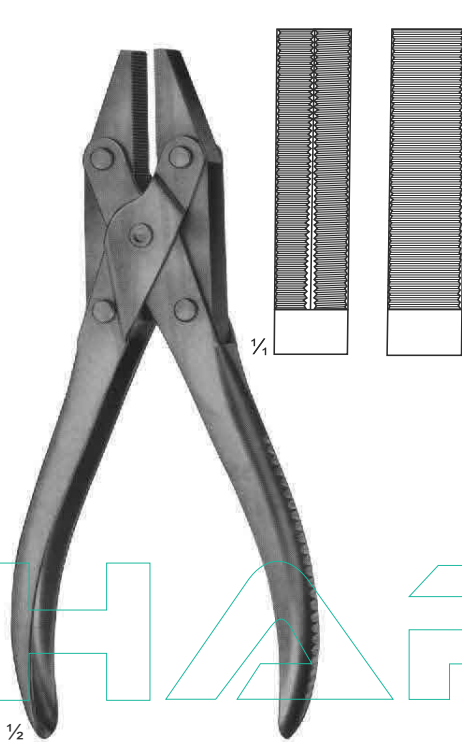

23-177
Flat-nosed pliers, parallel 185 mm

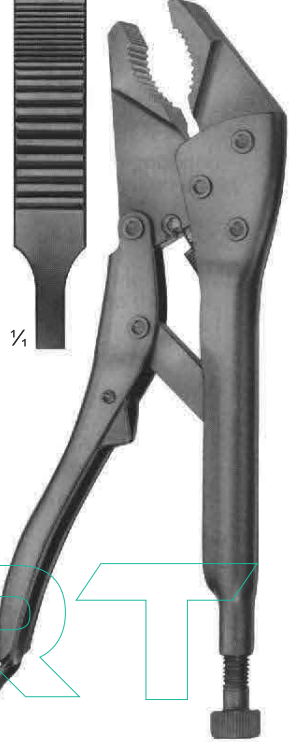

23-178
Vise grip 200 mm

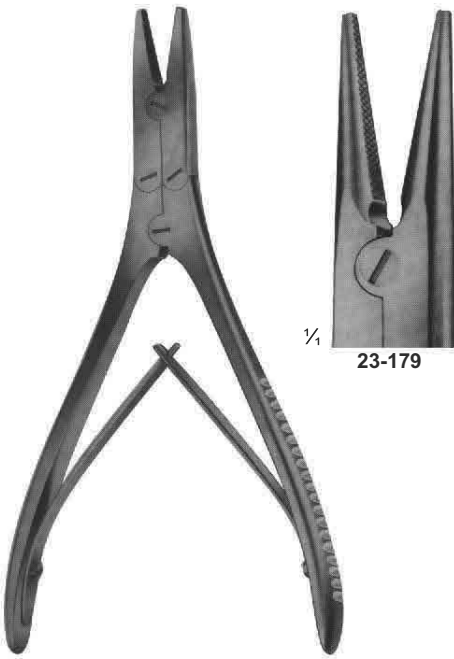

23-179 - 183
Round pliers 180 mm

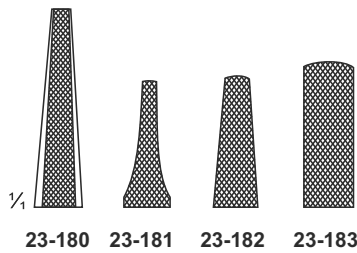

23-180
23-181 145 mm
23-182 180 mm
23-183 180 mm
Extraction pliers for wires

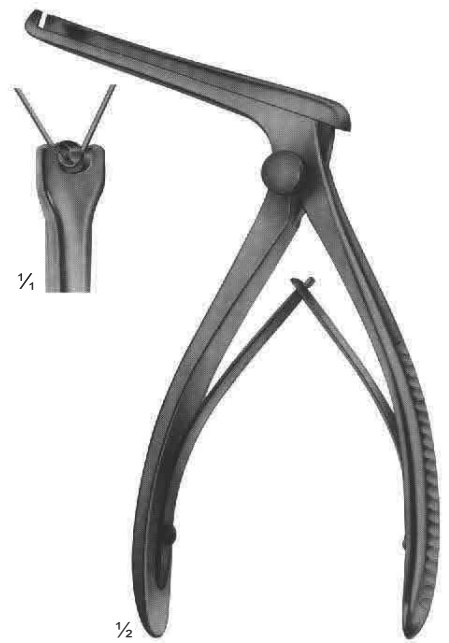

23-184
Bending pliers for wires up to 1.8 mm diam.

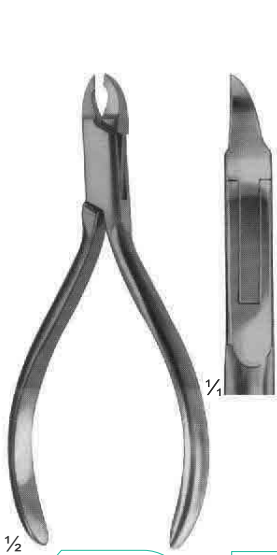

23-185
ANGLE
130 mm

for soft wire
up to diam.
for hard wire
up to diam.

23-186
DUROTIP
ANGLE
130 mm

0,5 mm 0,6 mm
0,3 mm 0,4 mm

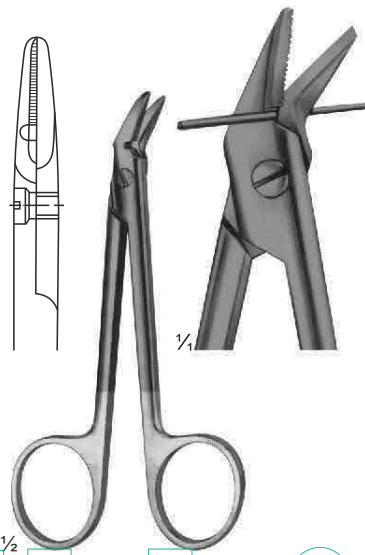

23-187
120 mm

for soft wire
up to diam.
for hard wire
up to diam.

23-188
DUROTIP
120 mm

1,2 mm 1,2 mm
0,8 mm 0,8 mm

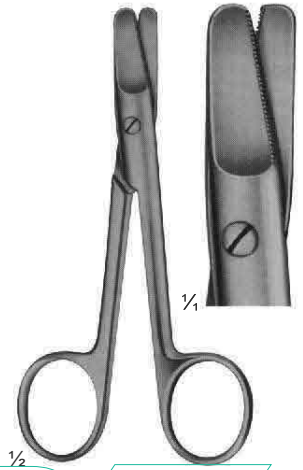

23-189
HARVEY
125 mm

0,4 mm
0,3 mm



23-190
150 mm

for soft wire
up to diam
for hard wire
up to diam

1,5 mm
1,0 mm



23-191
160 mm

1,5 mm
1,2 mm



23-192
140 mm

1,5 mm
1,0 mm

DENHART

INDUSTRY



23-193
180 mm

for soft wire up to diam. 2,0 mm
For hard wire up to diam. 1,5 mm
specially hardened cutting edges, front and lateral cutting action



23-194
REILL
175 mm

for soft wire up to diam. 2,0 mm
For hard wire up to diam. 1,6 mm
specially hardened cutting edges, for cutting off wires close to the bone



23-195
235 mm

for soft wire up to diam. 3,0 mm
For hard wire up to diam. 2,2 mm

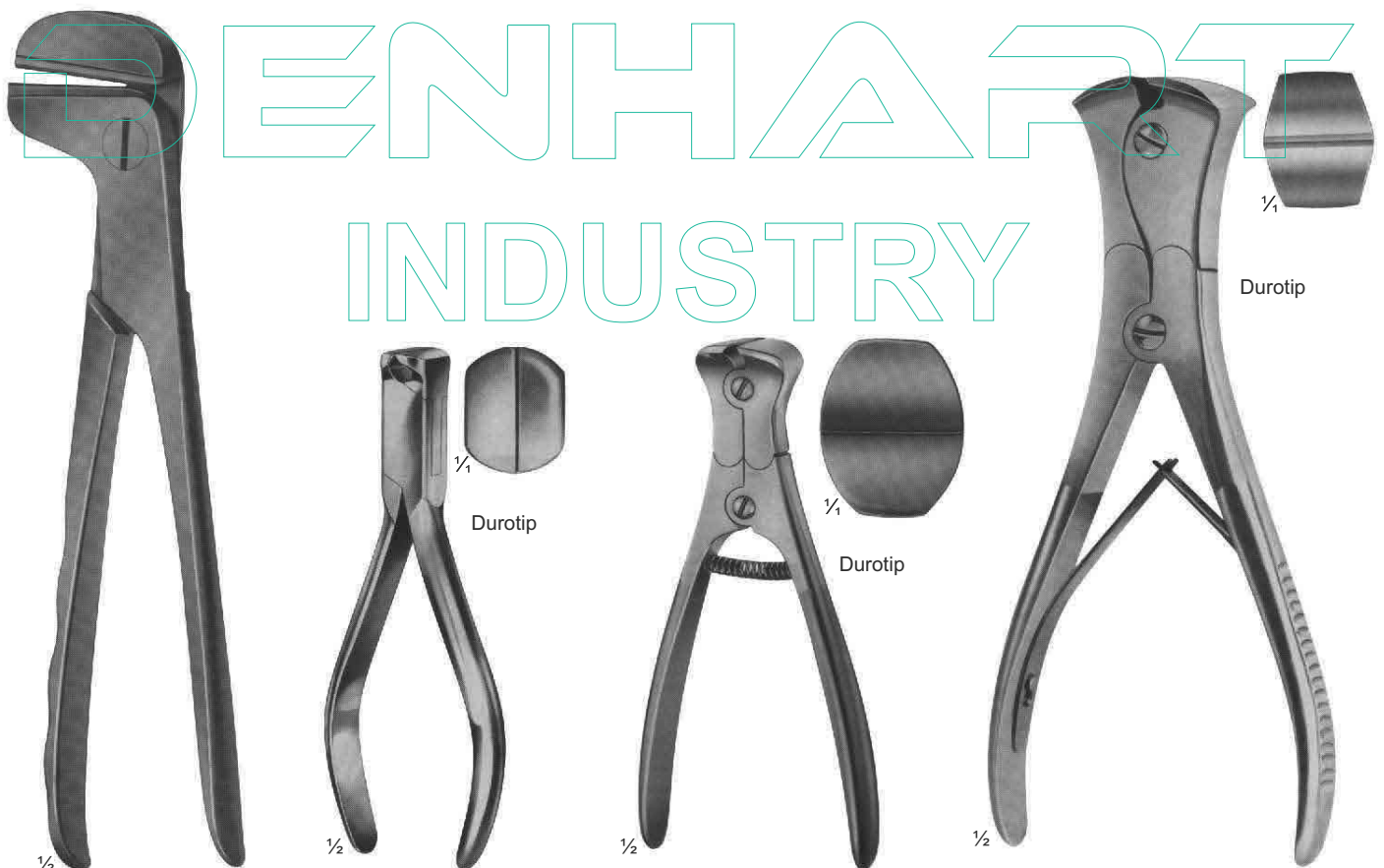

23-196
240 mm

for soft wire up to diam. 2,0 mm
For hard wire up to diam 1,6 mm

23-197
140 mm

for soft wire up to diam. 1,5 mm
For hard wire up to diam 1,0 mm

23-198
145 mm

for soft wire up to diam. 2,0 mm
For hard wire up to diam 1,5 mm

23-199
220 mm

for soft wire up to diam. 3,5 mm
For hard wire up to diam 2,5 mm

DENHART
INDUSTRY



1/3

Cutter for cutting off
KIRSCHNER wires,
Tibia head screws,
bolts, pins, up to 3 mm diam.

23-200
320 mm

for soft wire
up to diam. 3,0 mm
For hard wire
up to diam 3,0 mm

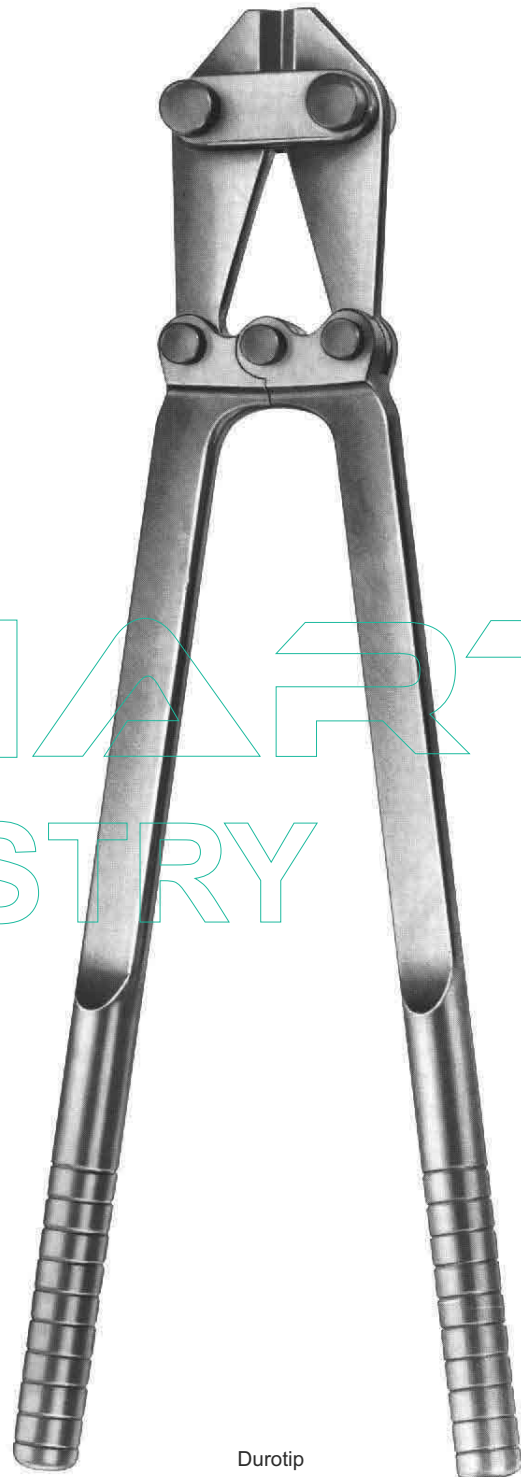

Durotip

23-201
Cutter for cutting off
KIRSCHNER wires,
Tibia head screws,
bolts, pins, up to 6 mm diam.
470 mm

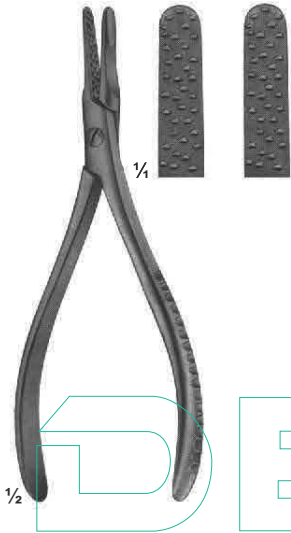

23-202
Nail extracting
forceps
135 mm



23-203
Nail extracting
forceps
145 mm

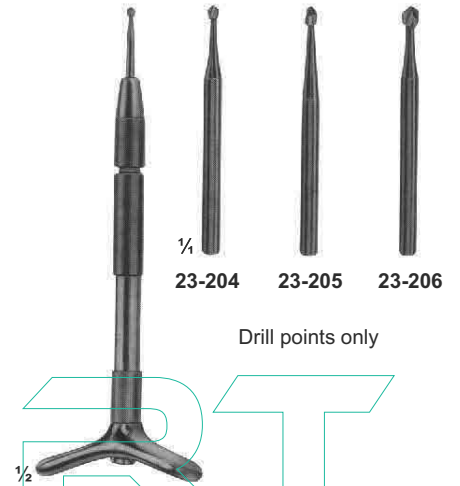

23-204 - 206
Finger nail drill
with 3 points

Drill points only

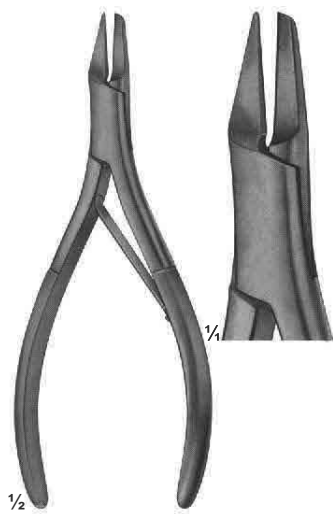

23-207
Nail splitting
forceps
135 mm

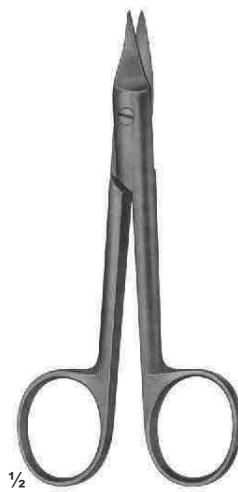

23-208
SYSTRUNK
Scissors, for splitting
finger nails
130 mm

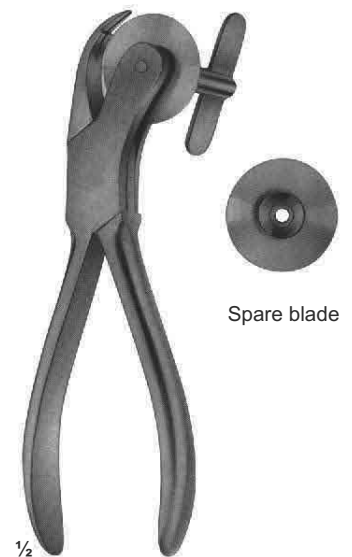

23-209
Finger ring saw
150 mm

Spare blade



with ebony handle

24-101
HOPKINS
200 mm



1/2

24-102
ESMARCH
180 mm



1/2

24-103
ENGEL
160 mm

DENHART
INDUSTRY

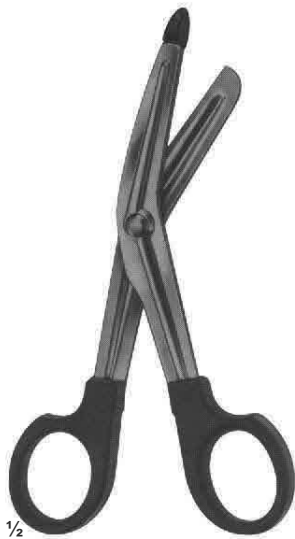

1/2

24-104 - 112

- | | | | |
|--------|-------|--------|-------------|
| 24-104 | black | 24-108 | yellow |
| 24-105 | red | 24-109 | white |
| 24-106 | blue | 24-110 | orange |
| 24-107 | green | 24-111 | lavender |
| | | 24-112 | bright pink |



1/2

24-113 - 121

- | | | | |
|--------|-------|--------|-------------|
| 24-113 | black | 24-117 | yellow |
| 24-114 | red | 24-118 | white |
| 24-115 | blue | 24-119 | orange |
| 24-116 | green | 24-120 | lavender |
| | | 24-121 | bright pink |

For small plaster dressings



24-122
160 mm

1/2

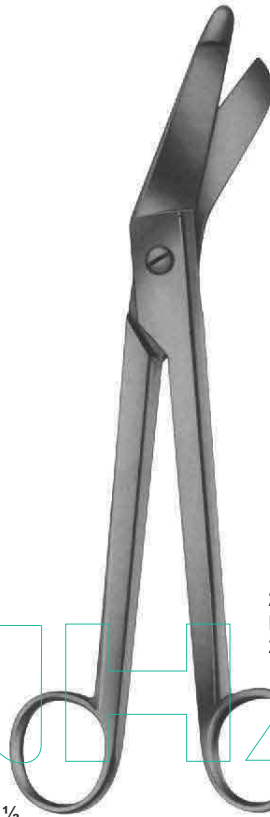

24-123 - 124
ESMARCH
200 mm 230 mm

1/2



24-125
BERGMANN
230 mm

1/2

DENHART
INDUSTRY



24-126
BRUNS
235 mm

1/2



24-127
235 mm

1/2

also to be used as
bandage scissors



24-128
SEUTIN
230 mm

1/2

also to be used as
bandage scissors

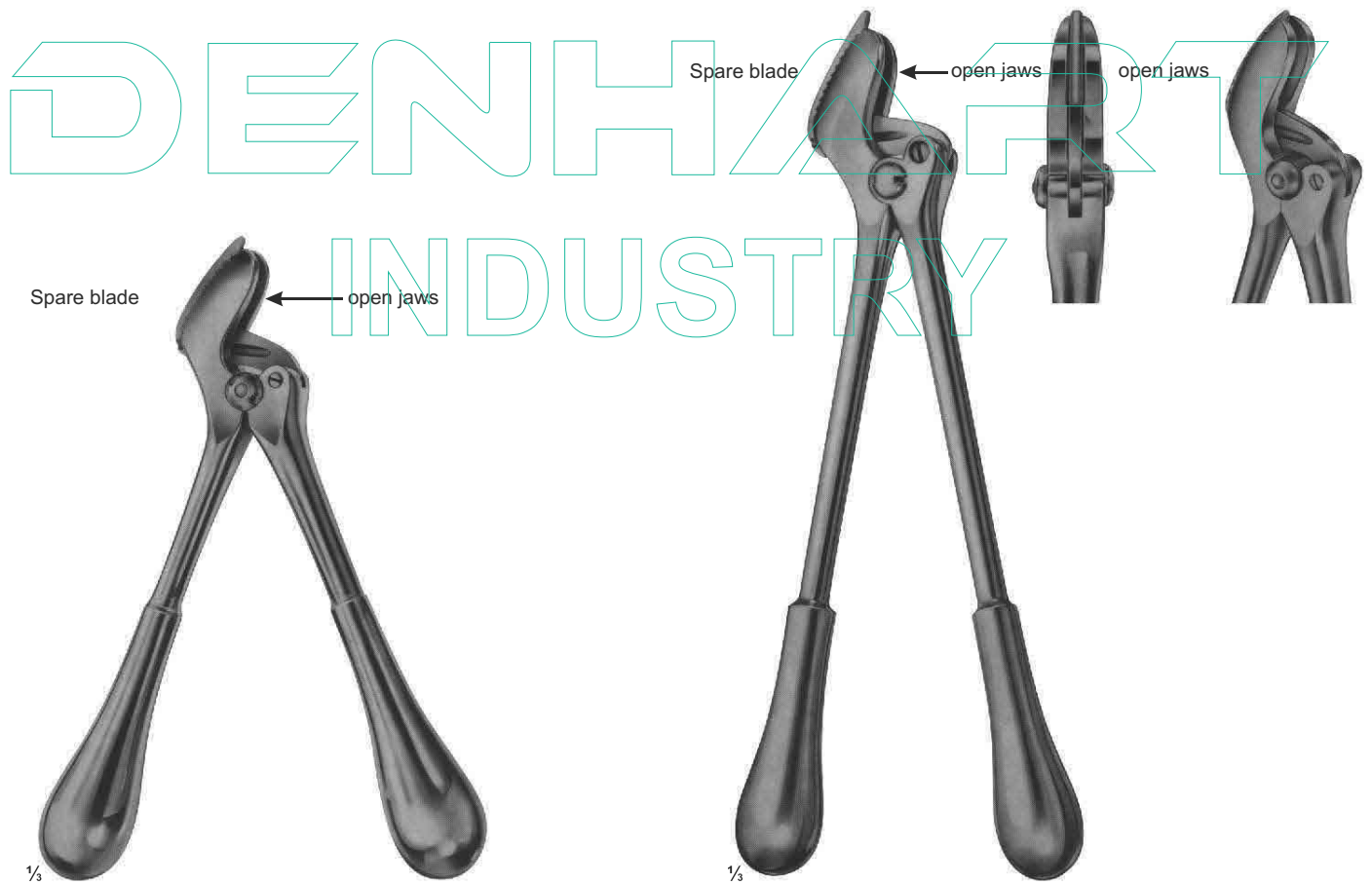

24-129
STILLE-AESCULAP
260 mm

24-130
STILLE-AESCULAP
360 mm

Blade with reinforced back

DENHART
INDUSTRY



24-131
STILLE
230 mm

24-132
Spare blade

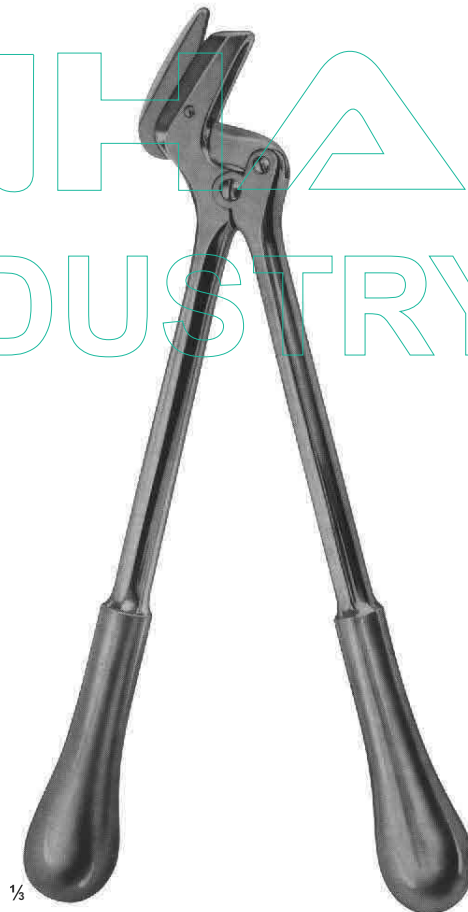

24-133
STILLE
370 mm

24-134
Spare blade



24-135
STILLE
240 mm

24-136
Spare blade

DENHART INDUSTRY



1/3

24-137
HENING
270 mm



1/3

24-138
MOD.USA
230 mm



1/3

24-139
290 mm



with removable jaws



1/3

24-140 - 141
WOLFF
24-140 180 mm
24-141 240 mm

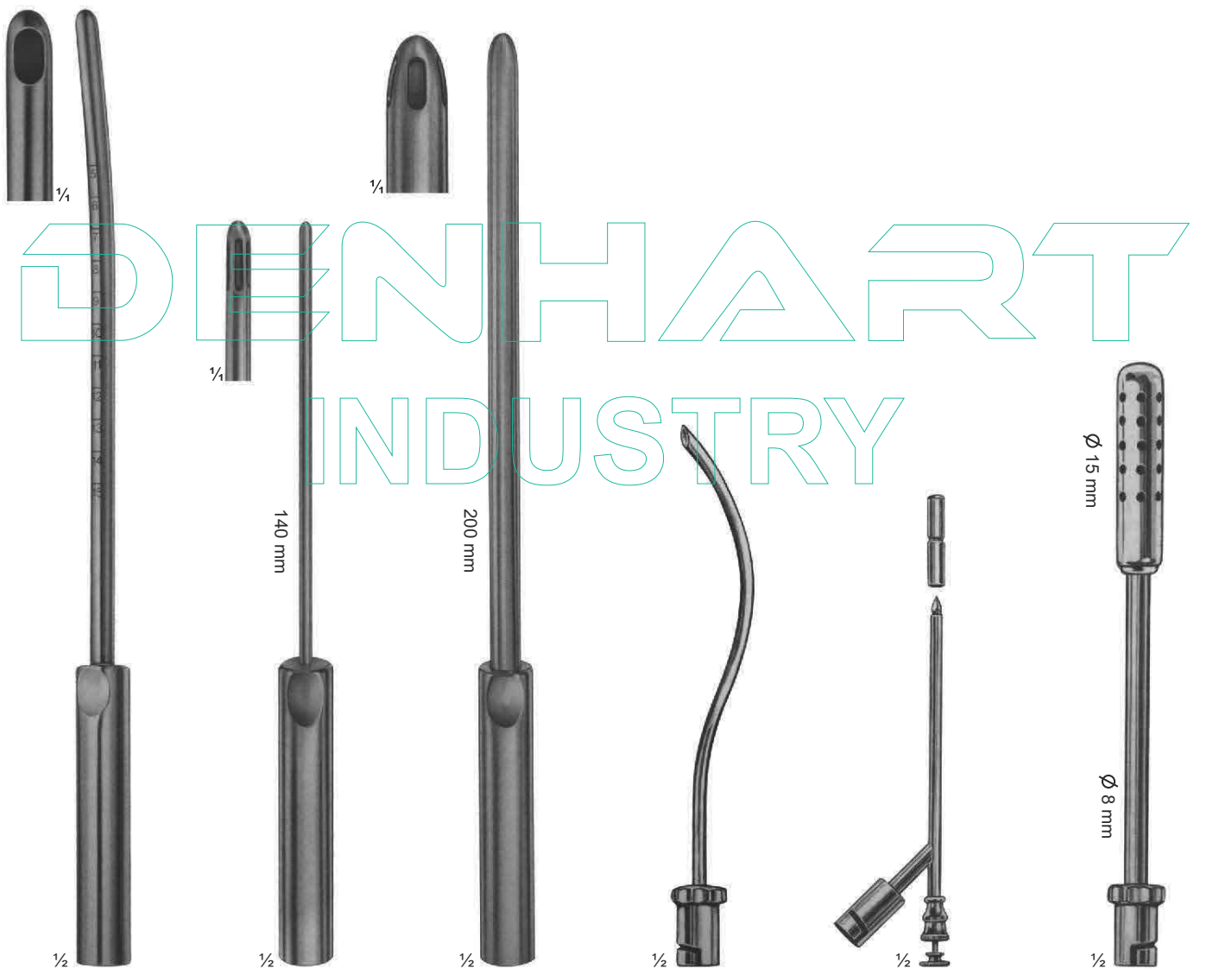

25-101 - 106

BIEMER

25-101 ø 4 mm

25-102 ø 6 mm

25-103 ø 8 mm

25-104 ø 10 mm

25-105 ø 12 mm

25-106 ø 14 mm

Currettes for aspiration lipectomy, graduated, slightly curved

25-107 - 108

BIEMER

25-107 ø 4 mm

25-108 ø 6 mm

Currettes for aspiration lipectomy, with three apertures, slightly curved malleable

25-109 - 111

BIEMER

25-109 ø 8 mm

25-110 ø 10 mm

25-111 ø 12 mm

Currettes for aspiration lipectomy, with three apertures, slightly curved malleable

25-112

For aspirating fluid from the excretory ducts of large glands and for keeping the operating area clear 170 mm

25-113

Trocar

For puncturing 150 mm

25-114

For clearing large quantities of fluid 190 mm

DENHART
INDUSTRY



25-115
Trocar
For puncturing
170 mm



25-116
Hollow needle,
sharp
150 mm



25-117
double curved
For general
surgery
230 mm



25-118
For tonsillectomy,
oral and laryngeal
operations
190 mm



25-119
For tonsillectomy,
oral and laryngeal
operations
220 mm

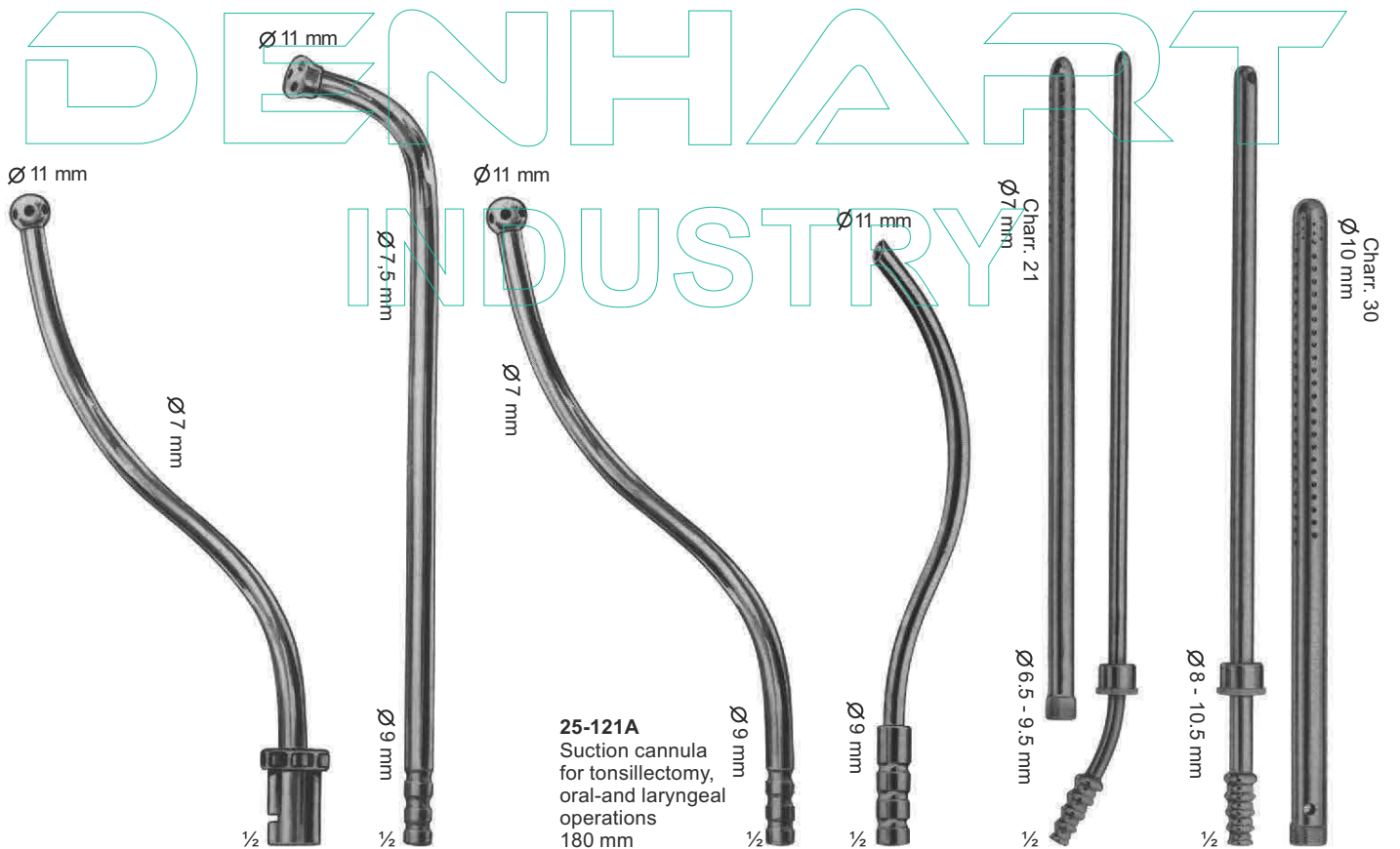

25-120
For tonsillectomy,
oral-and laryngeal
operations
180 mm

25-121
Suction cannula
for tonsillectomy,
oral-and laryngeal
operations
220 mm

25-121A
Suction cannula
for tonsillectomy,
oral-and laryngeal
operations
180 mm

25-122
S-shaped blunt cannula
for aspirating fluid from
the excretory ducts of
large glands and for
keeping the operations
area clear
170 mm

25-123
POOL
Suction cannula,
with outer tube
to be screwed of
225 mm

25-124
POOL
Suction cannula,
with outer tube
to be screwed of
225 mm

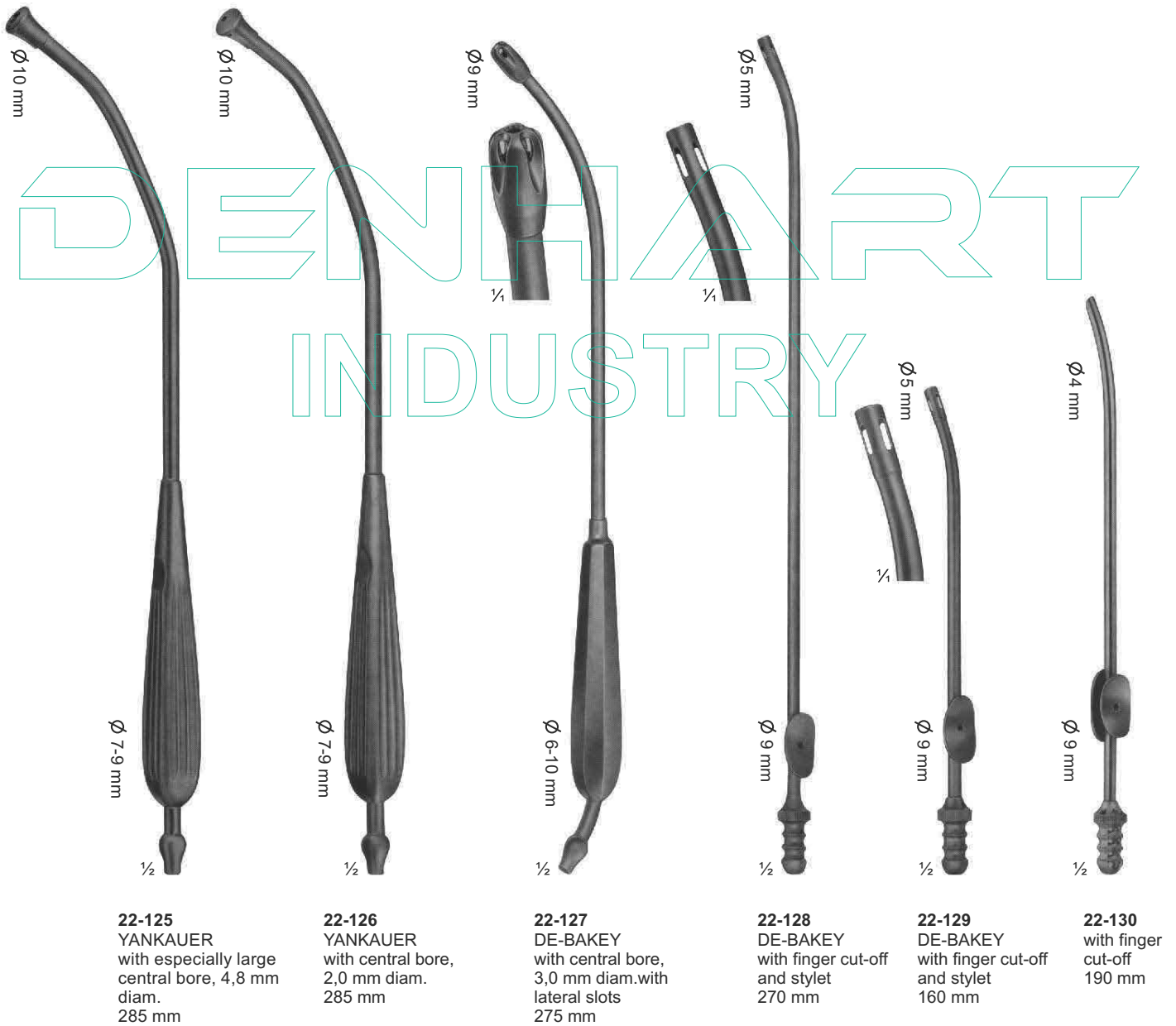

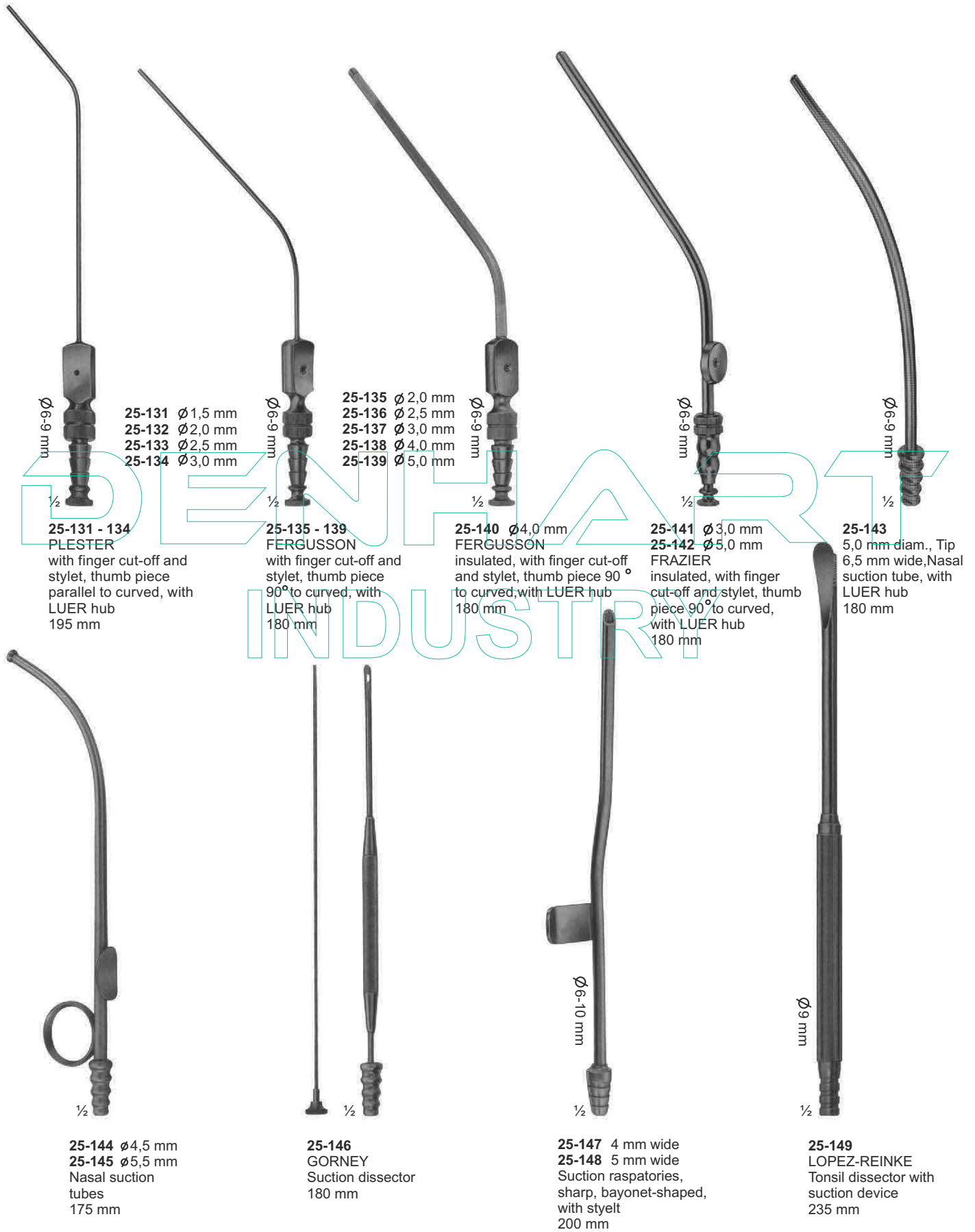

Ø6-9 mm

- 25-131 Ø 1,5 mm
- 25-132 Ø 2,0 mm
- 25-133 Ø 2,5 mm
- 25-134 Ø 3,0 mm

1/2

25-131 - 134
PLESTER
 with finger cut-off and stylet, thumb piece parallel to curved, with LUER hub
 195 mm

Ø6-9 mm

- 25-135 Ø 2,0 mm
- 25-136 Ø 2,5 mm
- 25-137 Ø 3,0 mm
- 25-138 Ø 4,0 mm
- 25-139 Ø 5,0 mm

1/2

25-135 - 139
FERGUSON
 with finger cut-off and stylet, thumb piece 90° to curved, with LUER hub
 180 mm

Ø6-9 mm

25-140 Ø4,0 mm
FERGUSON
 insulated, with finger cut-off and stylet, thumb piece 90° to curved, with LUER hub
 180 mm

1/2

Ø6-9 mm

25-141 Ø 3,0 mm
25-142 Ø 5,0 mm
FRAZIER
 insulated, with finger cut-off and stylet, thumb piece 90° to curved, with LUER hub
 180 mm

1/2

Ø6-9 mm

25-143
 5,0 mm diam., Tip 6,5 mm wide, Nasal suction tube, with LUER hub
 180 mm

1/2

1/2

25-144 Ø4,5 mm
25-145 Ø5,5 mm
 Nasal suction tubes
 175 mm

1/2

25-146
GORNEY
 Suction dissector
 180 mm

Ø6-10 mm

1/2

25-147 4 mm wide
25-148 5 mm wide
 Suction raspatories, sharp, bayonet-shaped, with stylet
 200 mm

Ø9 mm

1/2

25-149
LOPEZ-REINKE
 Tonsil dissector with suction device
 235 mm

25-150
WULLSTEIN
 Suction tube, conical, silver, oliver
 with LUER hub
 160 mm



25-151 1,5 mm
25-152 2,0 mm
WULLSTEIN
 Suction tube, cylindrical, silver, with
 stylet with LUER hub
 160 mm



Usable length

YASARGIL usable length diam.			YASARGIL usable length diam.		
25-153	130 mm	1,5 mm	25-161	130 mm	2,5 mm
25-154	150 mm	1,5 mm	25-162	150 mm	2,5 mm
25-155	180 mm	1,5 mm	25-163	180 mm	2,5 mm
25-156	220 mm	1,5 mm	25-164	220 mm	2,5 mm
25-157	130 mm	2,0 mm	25-165	130 mm	3,5 mm
25-158	150 mm	2,0 mm	25-166	150 mm	3,5 mm
25-159	180 mm	2,0 mm	25-167	180 mm	3,5 mm
25-160	220 mm	2,0 mm	25-168	220 mm	3,5 mm
			25-169	180 mm	4,5 mm

Ø6,5-9 mm with LUER hub

25-170 - 172
LANDOLT
 150 MM
 diam Ø3 mm

25-170 8 mm / curved
25-171 11mm / curved
25-172 15mm / curved

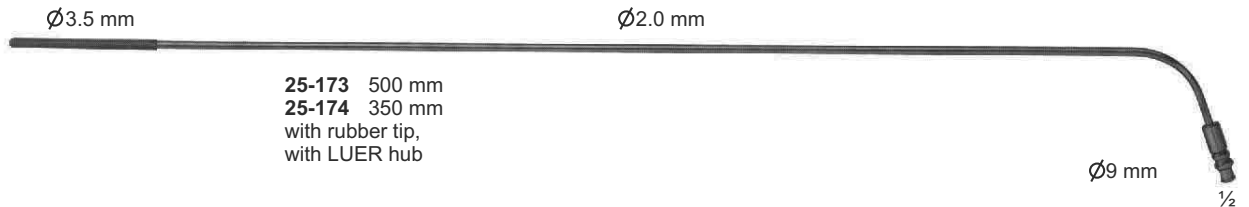

25-173 500 mm
25-174 350 mm
 with rubber tip,
 with LUER hub

25-175 2,0 mm diam
25-176 2,5 mm diam
25-177 3,0 mm diam
 with finger cut-off,
 thumb piece 90° to
 curved, with LUER hub
 250 mm

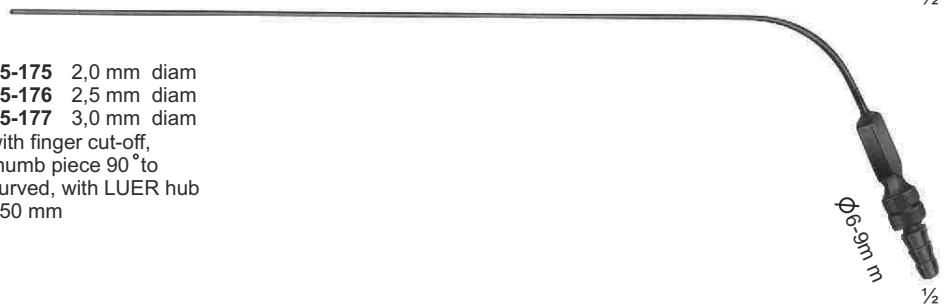

Combined Suction and Irrigation Cannulae

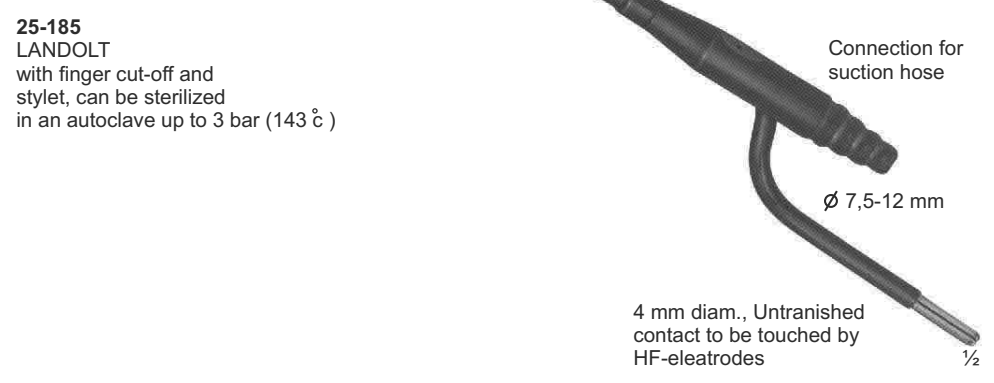
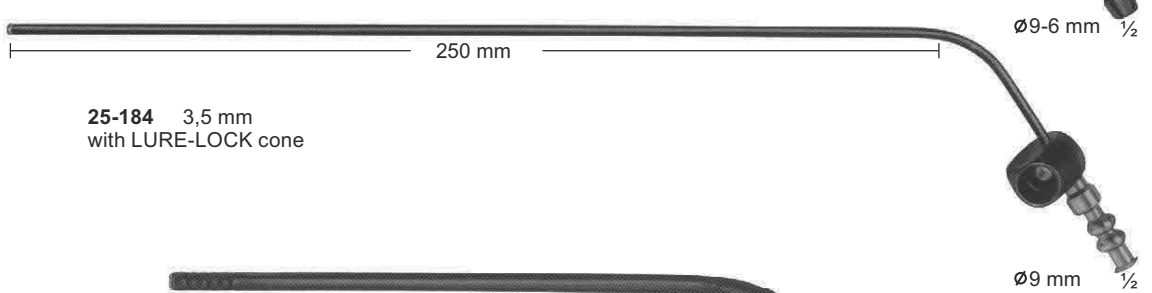
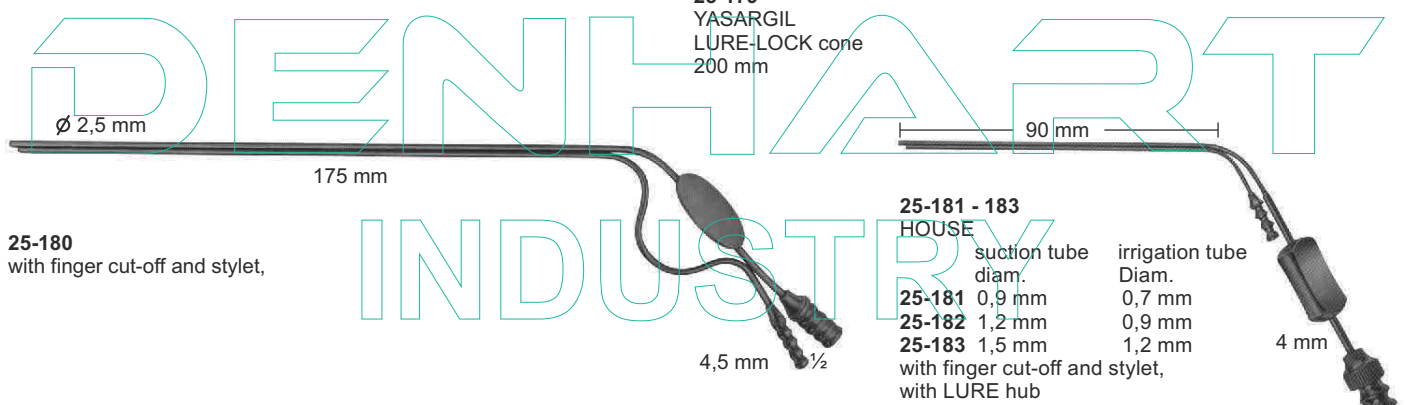
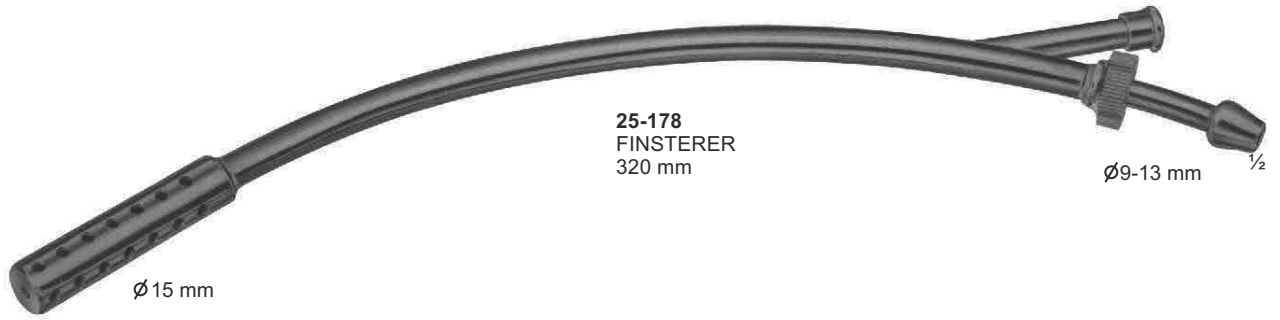

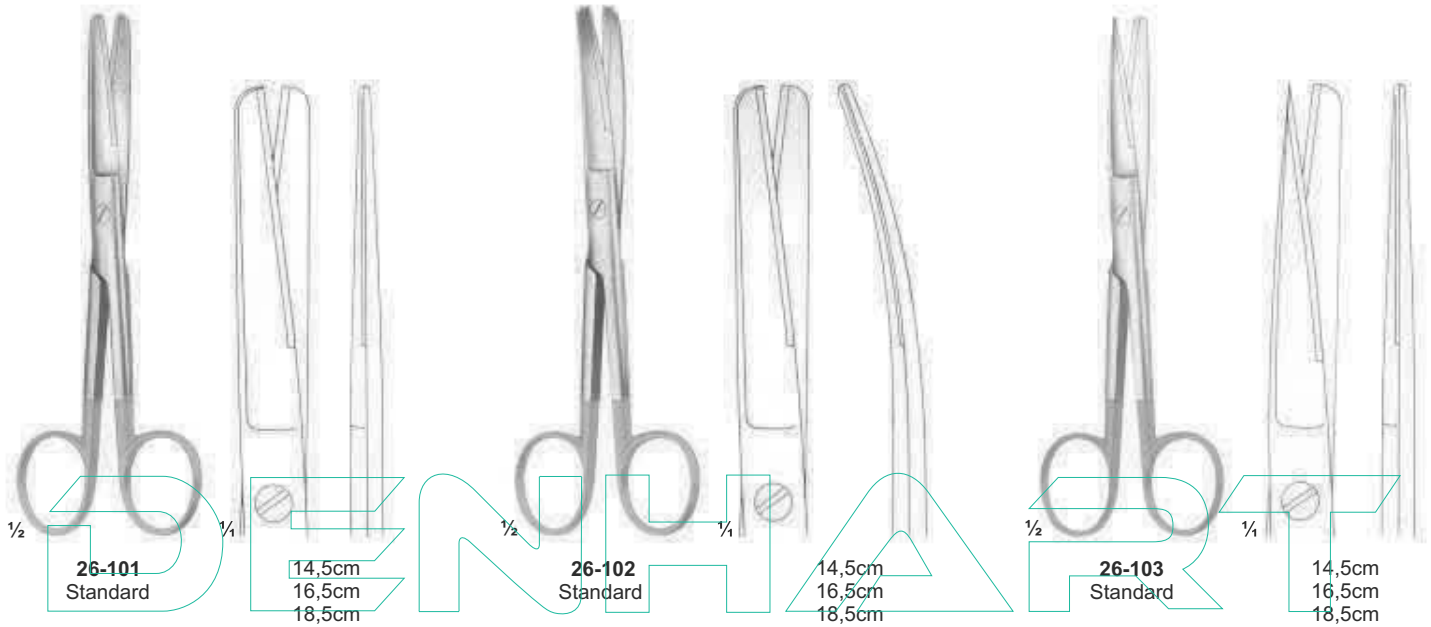

INDUSTRY

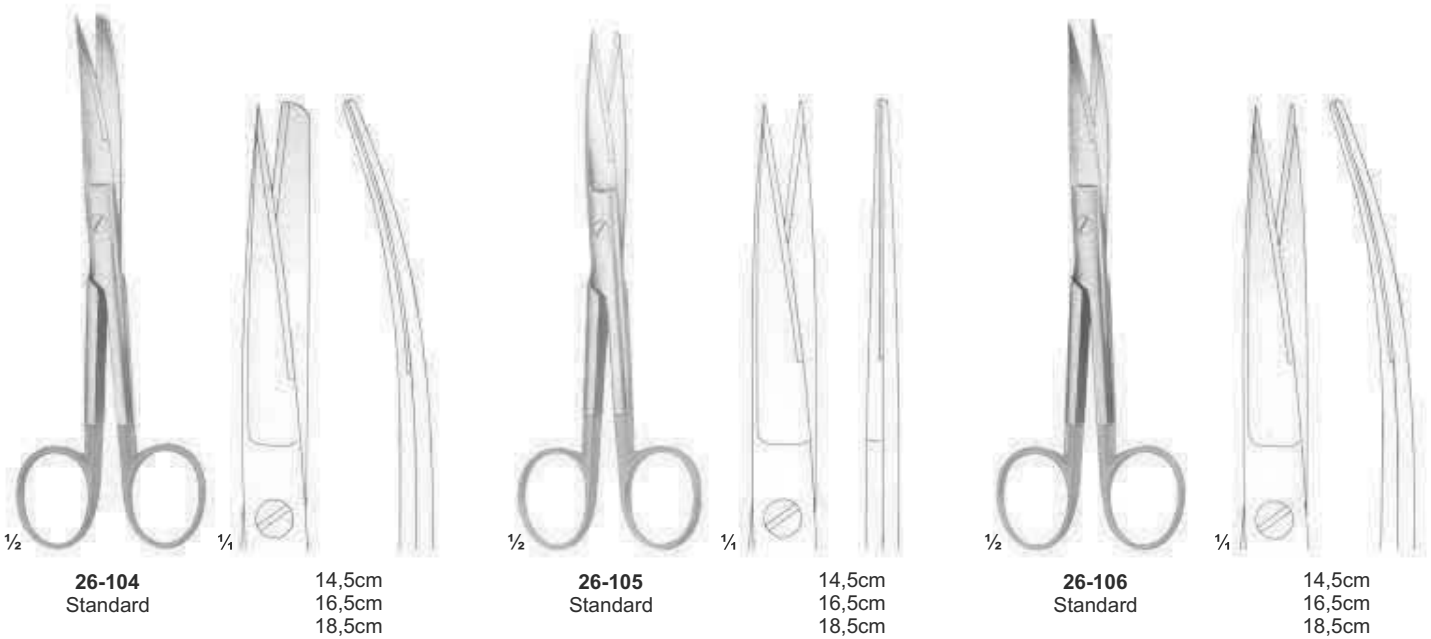



DENHART
INDUSTRY

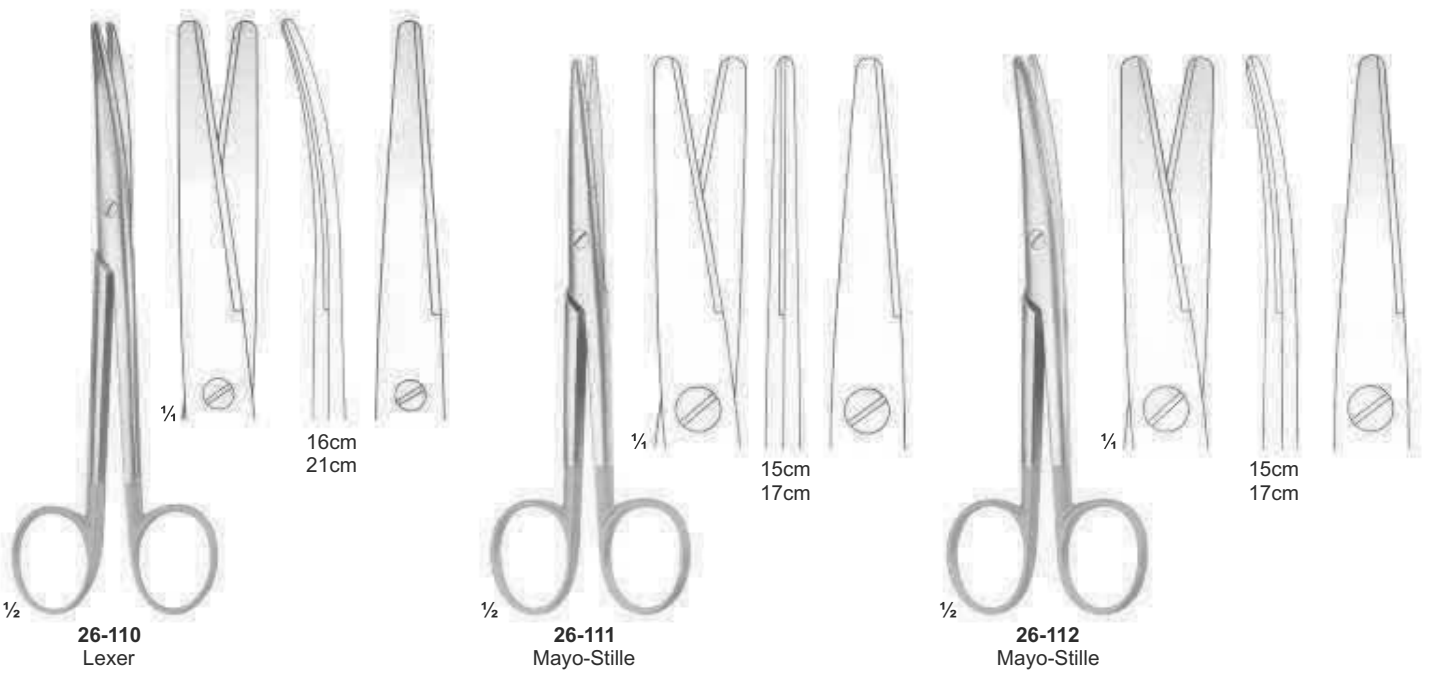

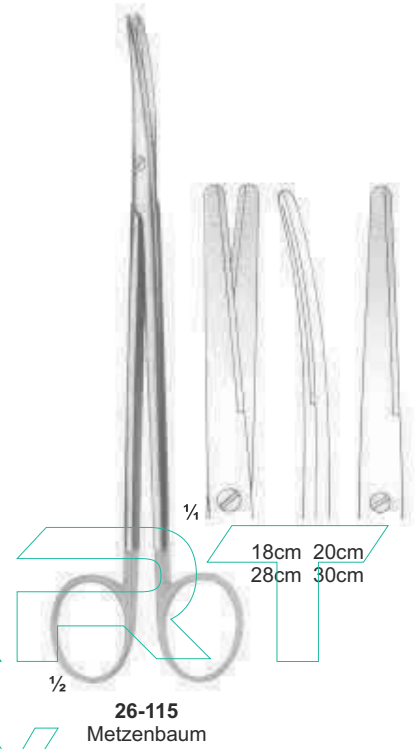
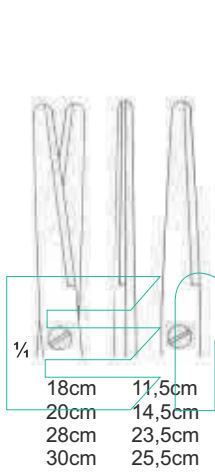
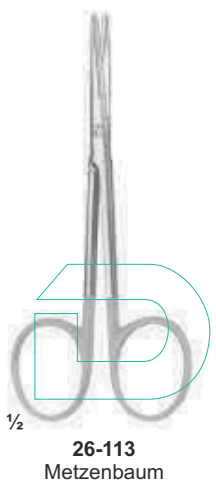

INDUSTRY

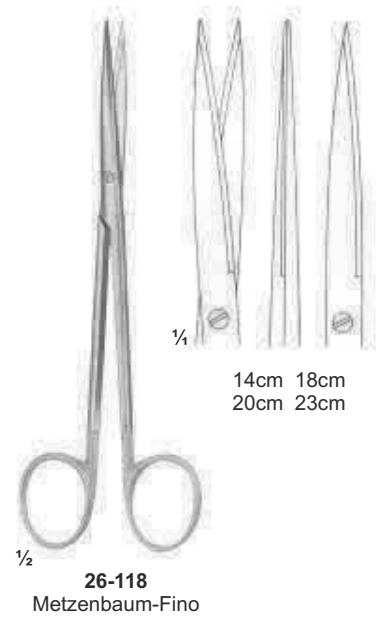
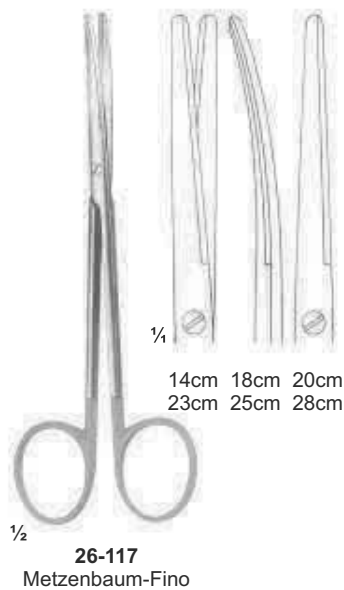

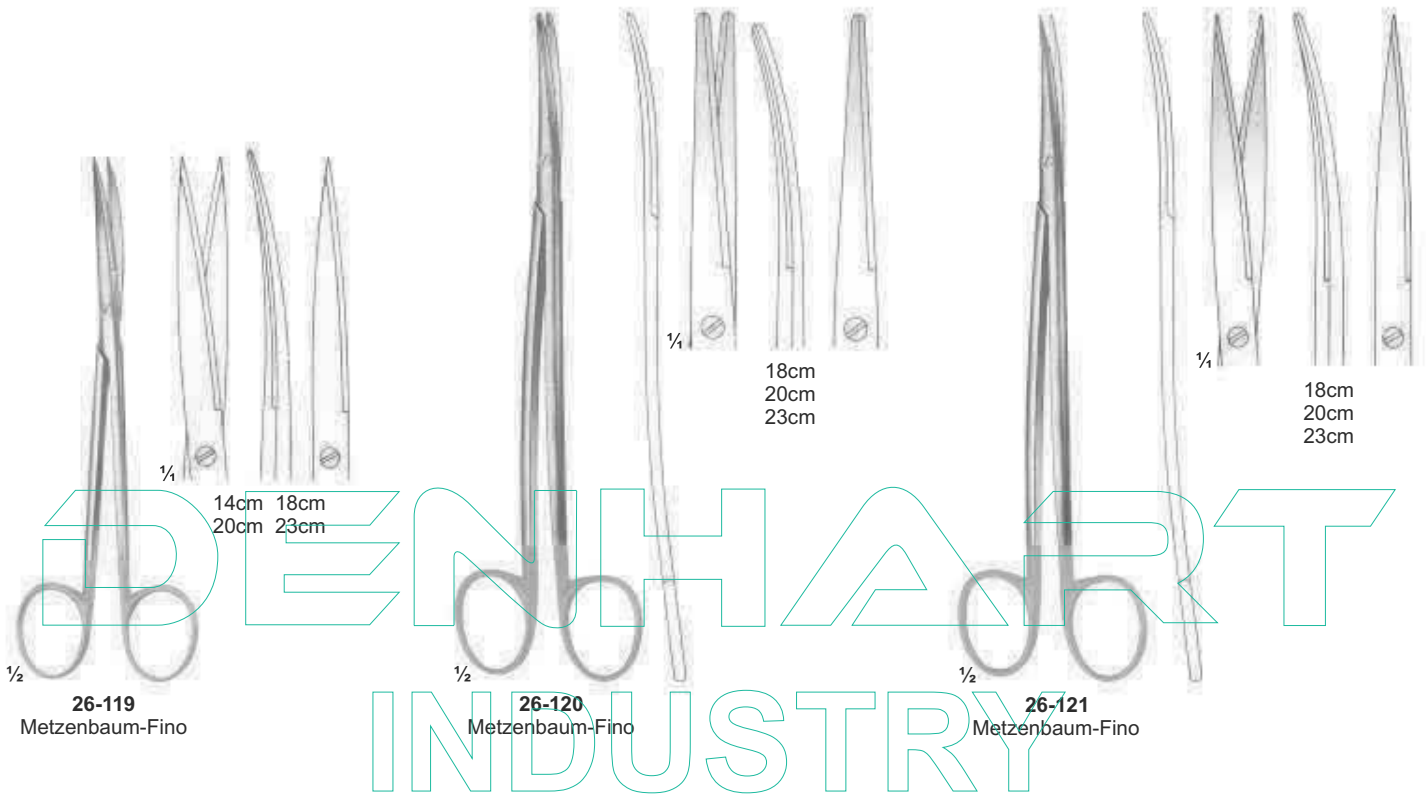

26-119
Metzenbaum-Fino

26-120
Metzenbaum-Fino

26-121
Metzenbaum-Fino

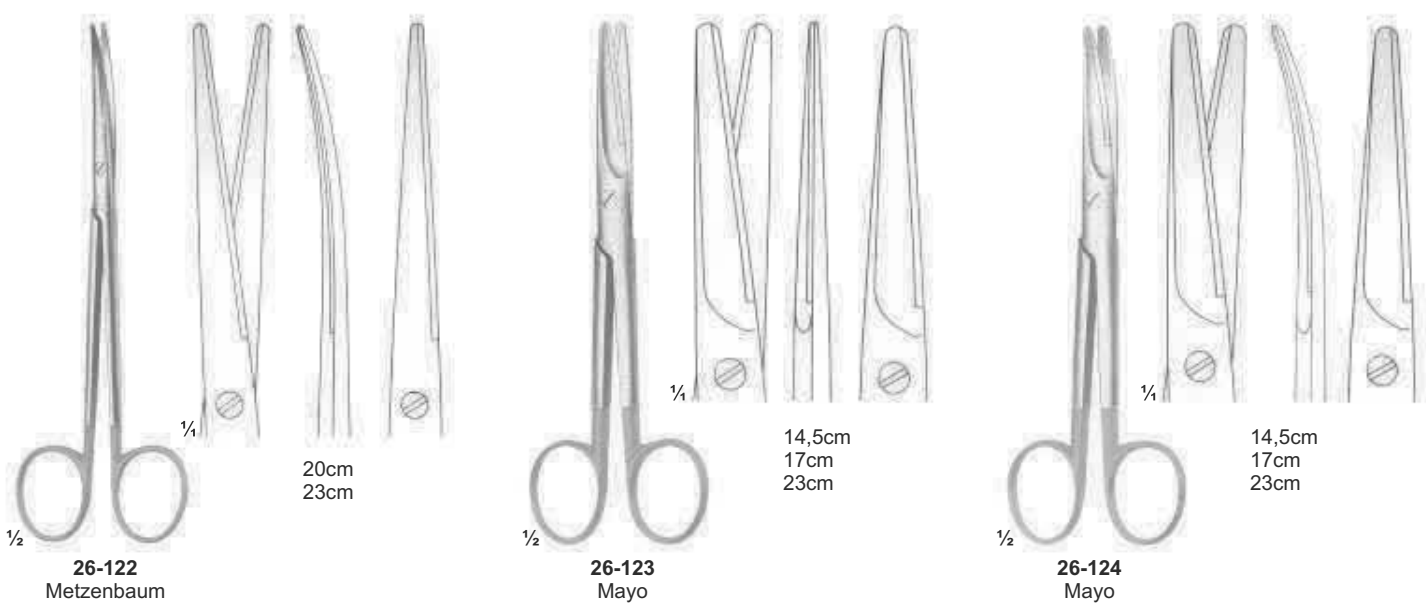

26-122
Metzenbaum

26-123
Mayo

26-124
Mayo



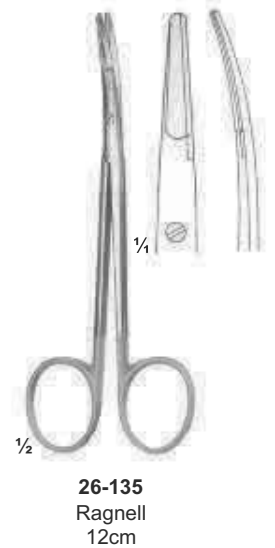
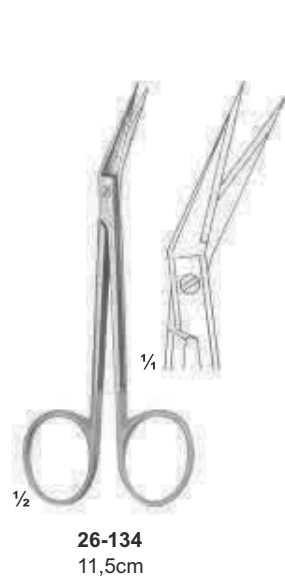
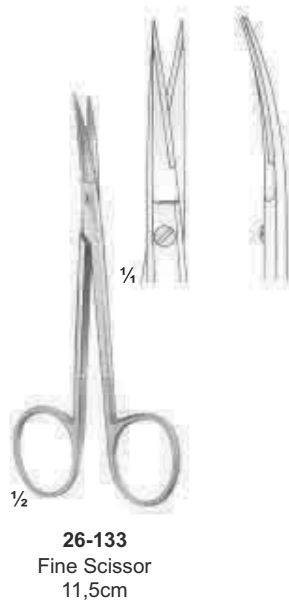
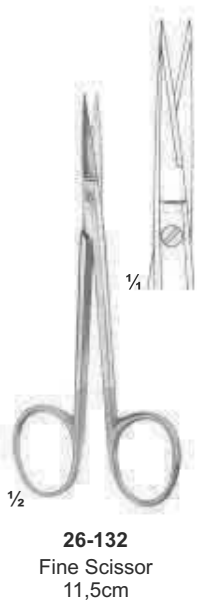
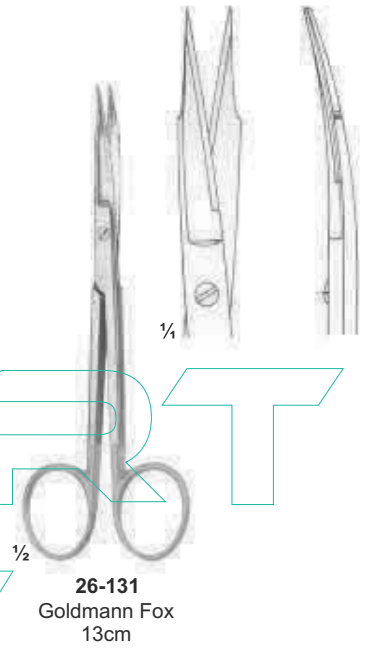
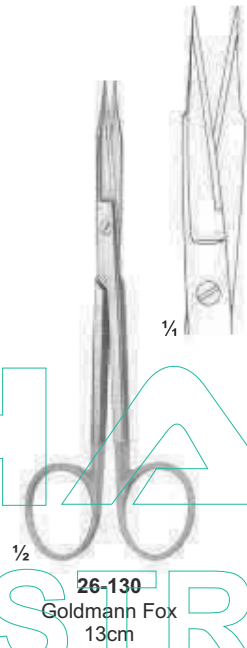

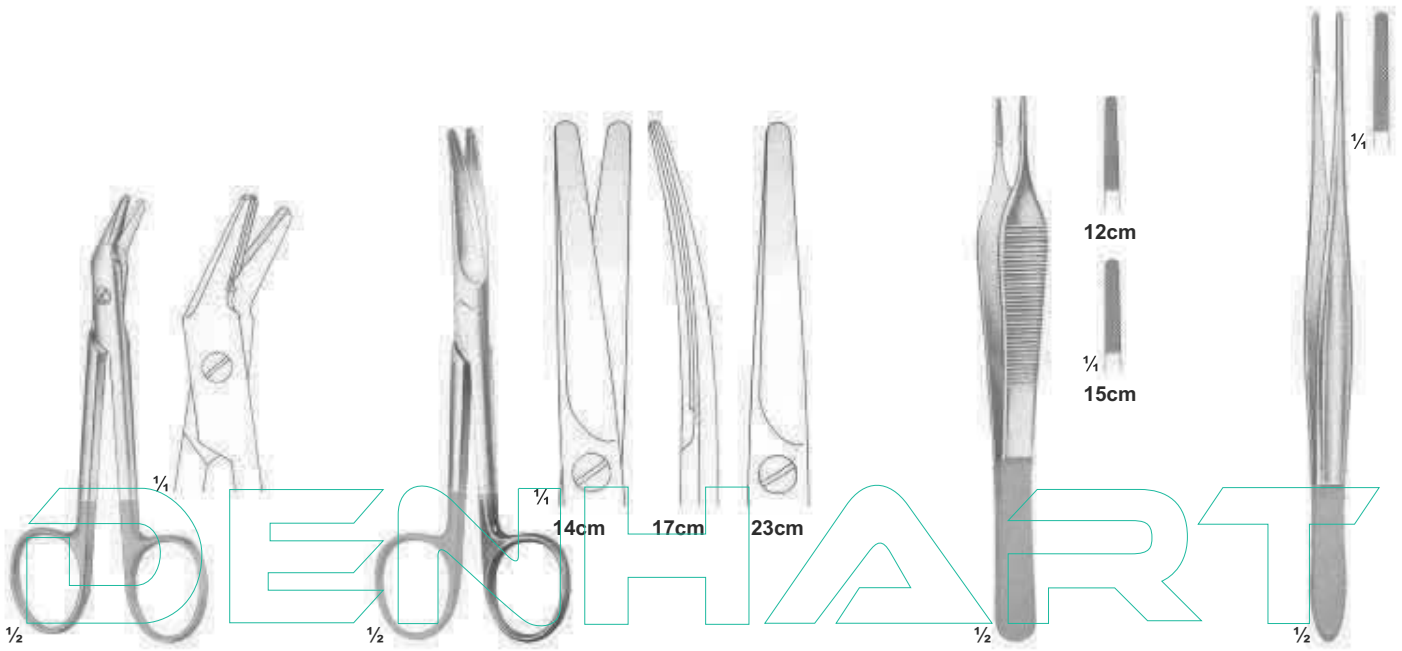

26-136
Universal
12cm

26-137
Ligature Scissors
1 Black & 1 Goldplated ring

26-138
Adson

26-139
Cushing
17,5cm

DENHART INDUSTRY



26-140
Cushing
18cm



26-141
Cushing-Taylor
18cm



26-142
Dissecting Forceps
15cm



26-143
Semken
15cm

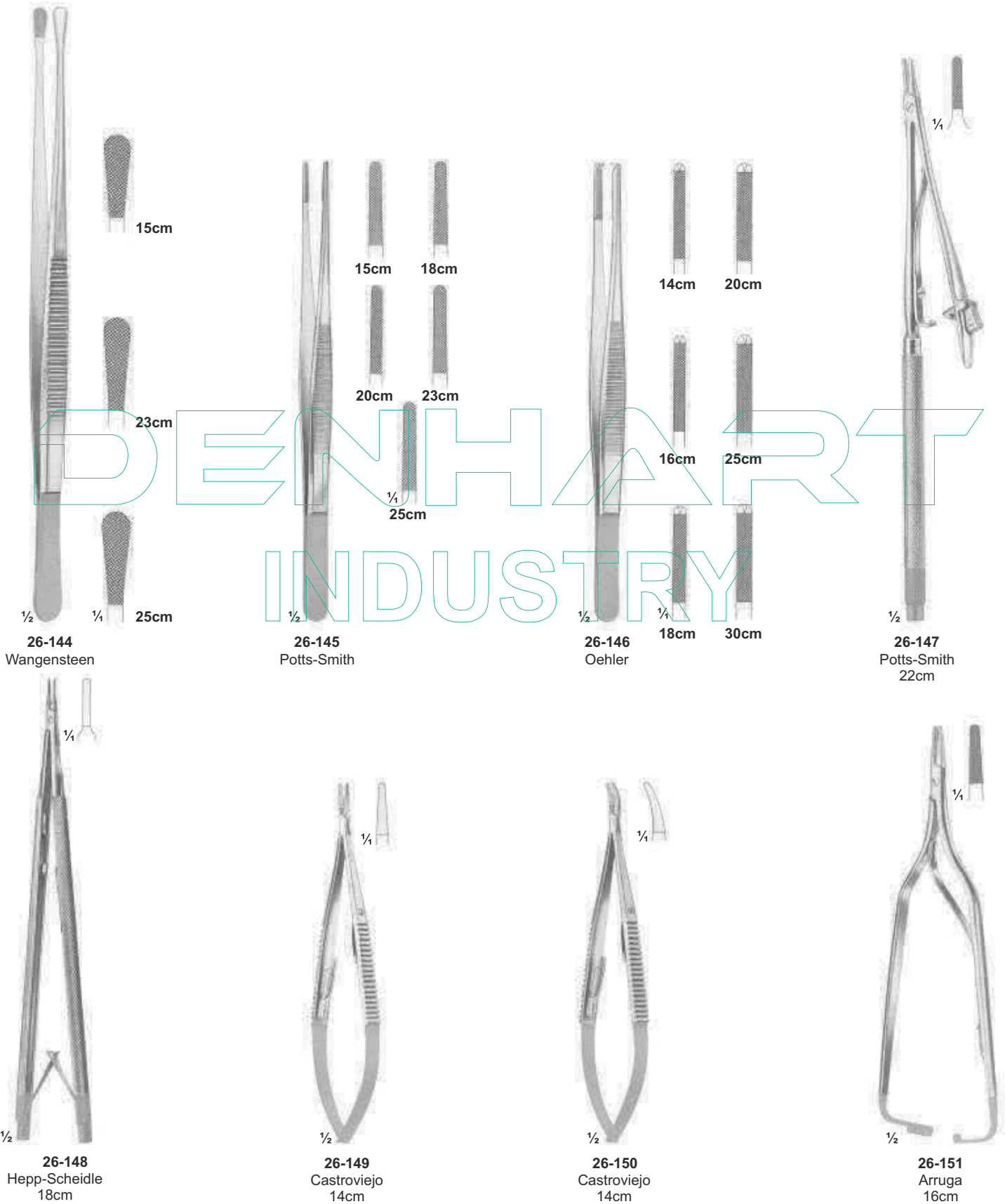

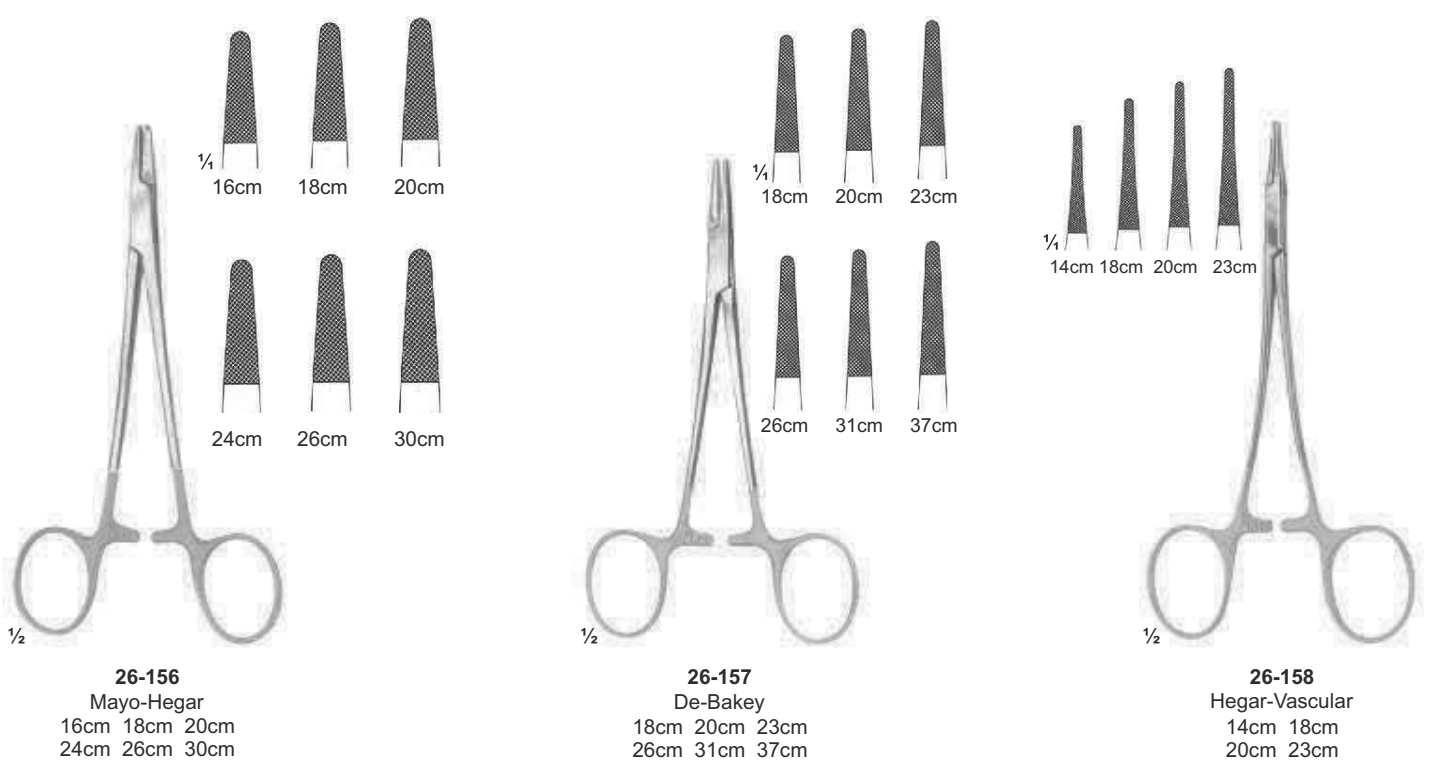
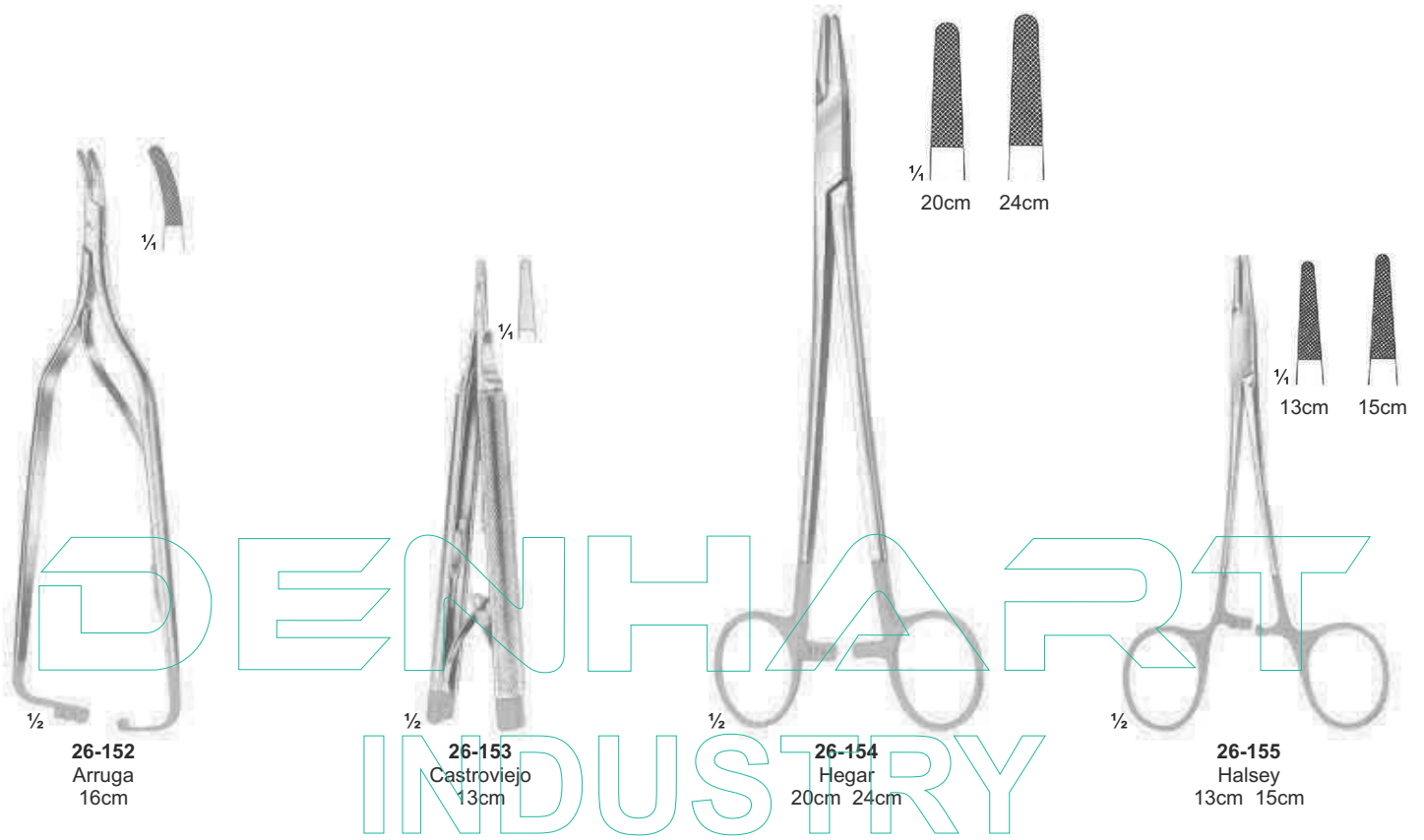



$\frac{1}{2}$
26-159
 Bozemann-Wertheim
 20cm 24cm 26cm

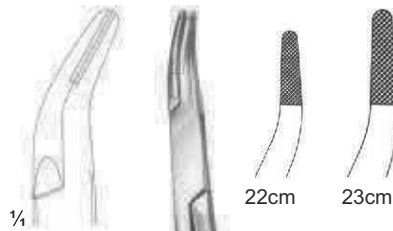

$\frac{1}{2}$
26-160
 Stratte
 22cm 23cm

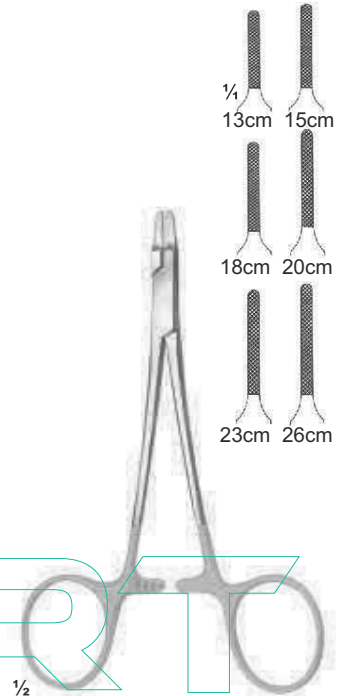

$\frac{1}{2}$
26-161
 Ryder
 13cm 15cm 18cm
 20cm 23cm 26cm

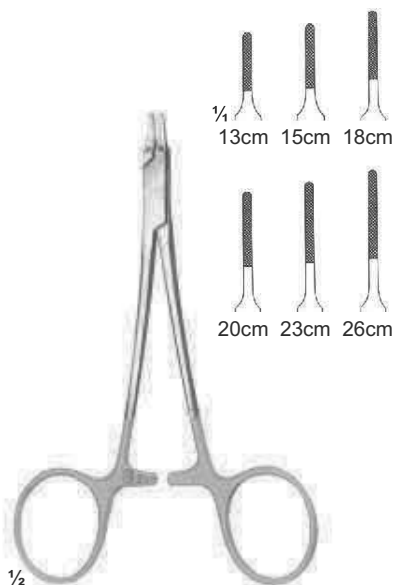
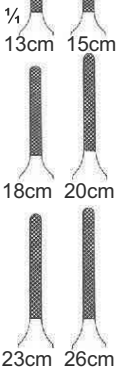

$\frac{1}{2}$
26-162
 Ryder-Vascular
 13cm 15cm 18cm
 20cm 23cm 26cm

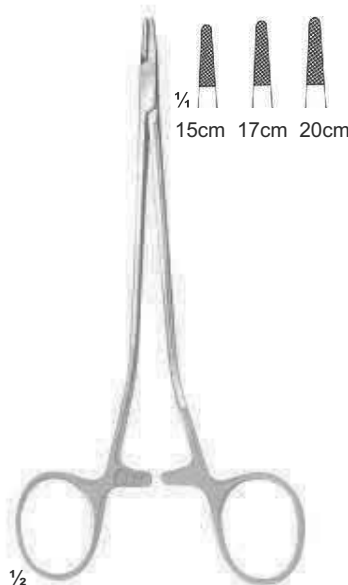
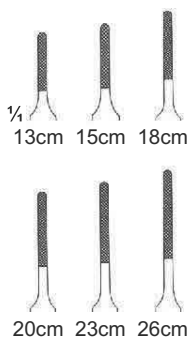

$\frac{1}{2}$
26-163
 Martin
 15cm 17cm 20cm

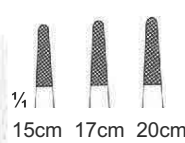

$\frac{1}{2}$
26-164
 Sarot
 18cm 20cm 26cm

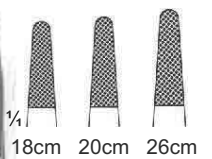

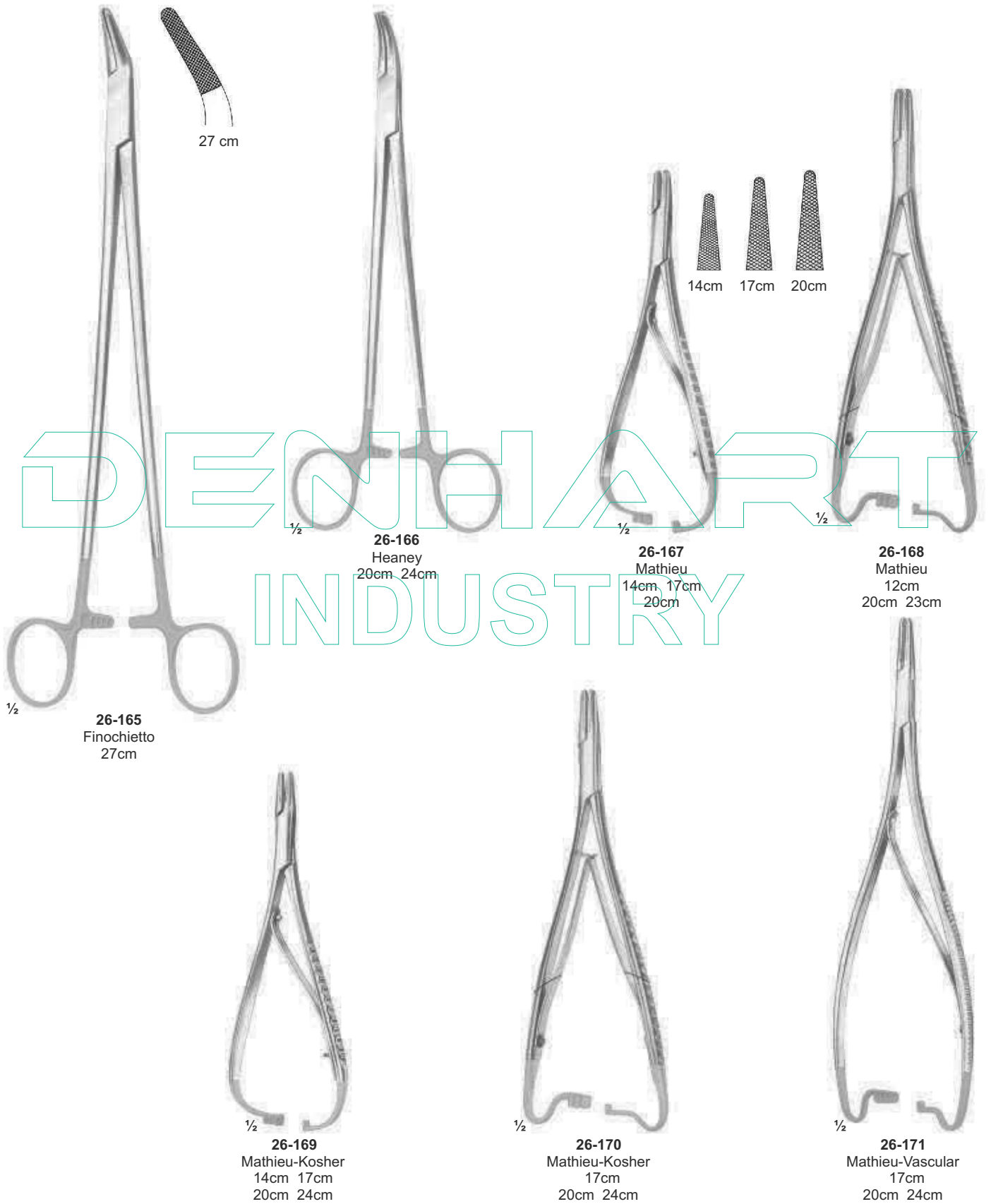



1/2
26-172
Mathieu-Ryder
17cm
20cm 24cm



1/2
26-173
Lichtenberg
20cm

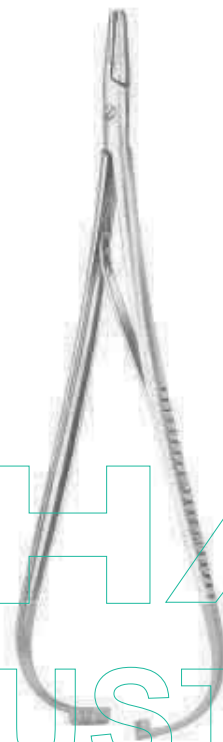

1/2
26-174
Langhals
20cm 25cm



1/2
26-175
Lichtenberg
20cm 25cm



1/2
26-176
Luehty-Beck
20cm 25cm

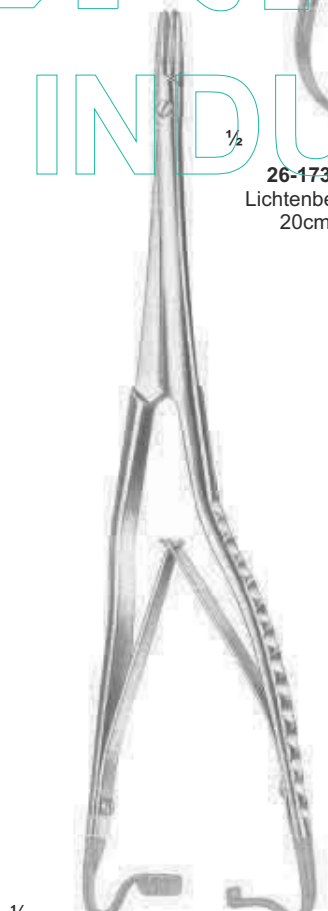

1/2
26-177
Luehty-Beck
20cm 25cm



1/2
26-178
Langebeck
18cm
20cm 23cm



1/2
26-179
Langebeck-beck
18cm
20cm 23cm

DENHART
INDUSTRY



27-101 - 115
Schimmelbüsch

	Ø x H sizes in mm
27-101	80 x 80
27-102	105 x 120
27-103	140 x 140
27-104	160 x 120
27-105	160 x 150
27-106	190 x 150
27-107	190 x 190
27-108	240 x 160
27-109	240 x 240
27-110	290 x 160
27-111	290 x 240
27-112	340 x 160
27-113	340 x 340
27-114	390 x 190
27-115	390 x 290

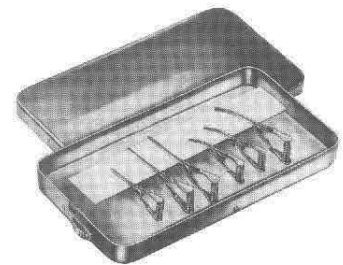

27-116
Box
120 x 65 x 13mm
(without Bulldog clamps,
without silicone tape)



27-117
Box with support
120 x 65 x 13 mm
(ohne Bulldogklemmen)

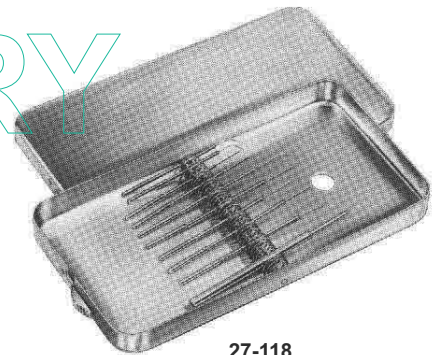

27-118
Box with support for
needle electrodes,
without instruments

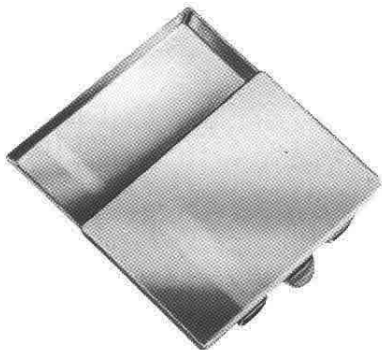

27-119 - 121
50 x 25 x 4,5 mm
27-120
65 x 42 x 8 mm
27-121
75 x 25 x 4,5 mm

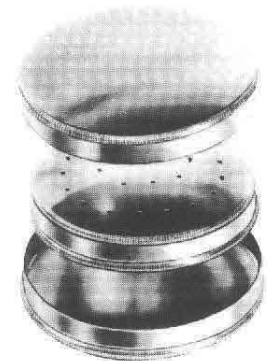

27-122
Ø 65mm x 15mm



27-123 - 131

	Ø x H
27-123	30 x 90 mm
27-124	50 x 100 mm
27-125	50 x 130 mm
27-126	50 x 175 mm
27-127	75 x 100 mm
27-128	75 x 130 mm
27-129	75 x 175 mm
27-130	100 x 175 mm
27-131	100 x 200 mm

DENHART
INDUSTRY



27-132 - 139

27-132	165 x 85 x 35 mm
27-133	200 x 100 x 35 mm
27-134	200 x 100 x 50 mm
27-135	230 x 130 x 50 mm
27-136	260 x 150 x 50 mm
27-137	270 x 235 x 50 mm
27-138	300 x 200 x 50 mm
27-139	325 x 275 x 50 mm



27-140
205 x 105 x 35 mm

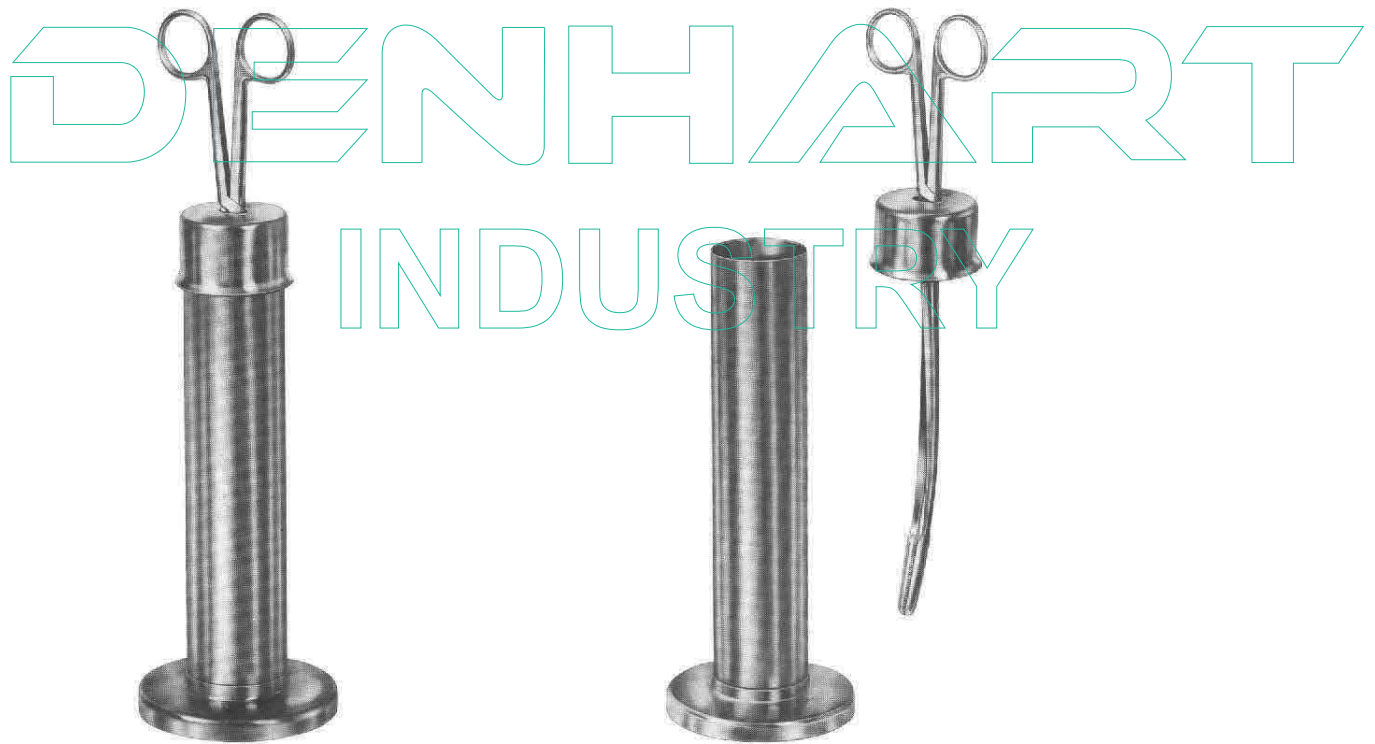

27-141 - 142

- 27-141** | Martin Sterilizing Forceps
consisting of:
1 Sterilizing Forceps, curved, 25 cm,
without ratchet, with lid for jar
1 jar with bottom plate (anti-tilt)
- 27-142** | ditto, with 32 cm long Sterilizing Forceps



27-143 - 148

	Ø x H
27-143	75 x 60 mm
27-144	75 x 75 mm
27-145	100 x 60 mm
27-146	100 x 100 mm
27-146A	125 x 80 mm
27-147	125 x 125 mm
27-148	150 x 150 mm

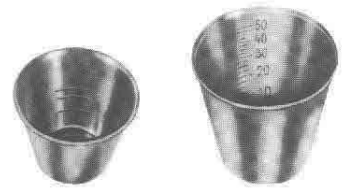

27-149
25 cc

27-150
50 cc



27-151
20 cc
Medicine Spoon

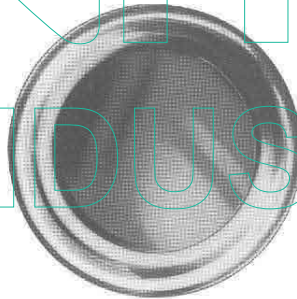

27-152
Ø75 x 12 mm
Tablet Tray



27-153
Ø90 x 90 mm
Metal Cup



27-154
Ø75 x 80 mm
Sputum Cup

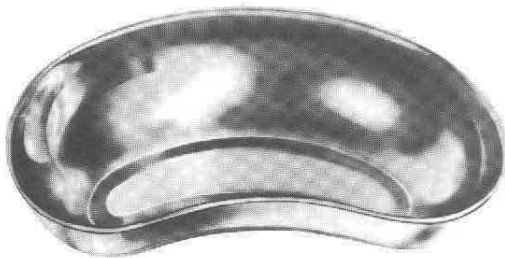

Kidney Dish

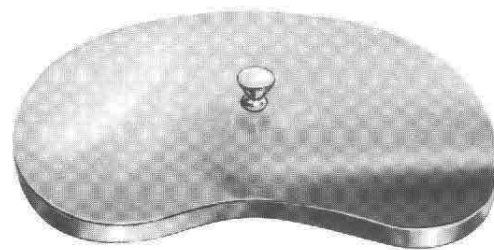

27-155 - 157

27-155	170 x 100 x 35 mm
27-156	250 x 140 x 40 mm
27-157	275 x 150 x 45 mm

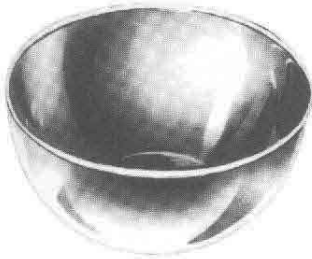

27-158 - 165

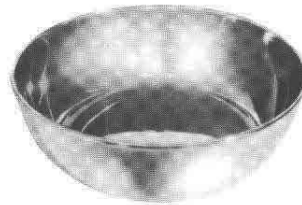

27-166 - 170

	Ø x H	
27-158	40 x 19 mm	0.05L
27-159	61 x 30 mm	0.07L
27-160	80 x 40 mm	0.14L
27-161	116 x 50 mm	0.35L
27-162	128 x 55 mm	0.45L
27-163	147 x 65 mm	0.70L
27-164	167 x 75 mm	1.10L
27-165	187 x 85 mm	1.60L

27-166	116 x 35 mm	0.30L
27-167	128 x 38 mm	0.40L
27-168	147 x 40 mm	0.50L
27-169	157 x 45 mm	0.75L
27-170	187 x 45 mm	1.00L

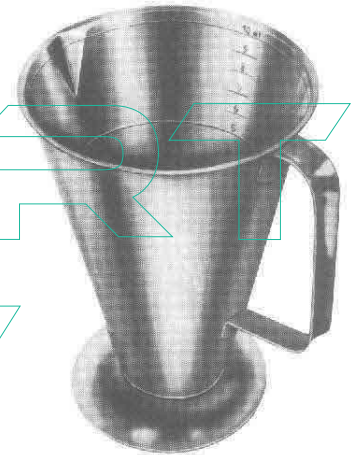

27-173 - 176

27-173	0,25L
27-174	0,50L
27-175	1,00L
27-176	2,00L

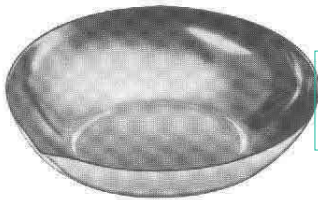

27-171
Ø 110 x 28 mm 0.15L

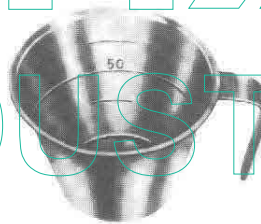

27-172
100 cc 0.1L



27-177
235 x 190 x 40 mm



27-178
Ø 220 x 70 mm

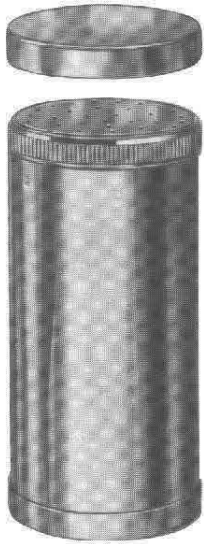

27-179
Ø 50 x 100 mm
Powder Pot

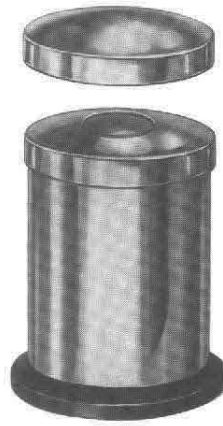

27-180
Ø 50 x 75 mm
Methot With Lid



27-181
Ø 50 x 75 mm
Methot Without Lid

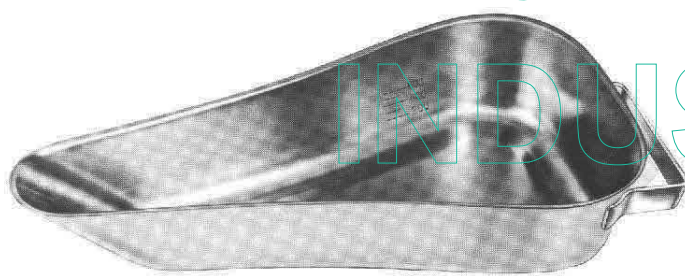

27-182

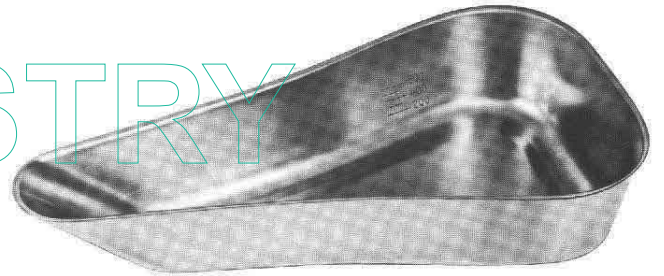

27-183

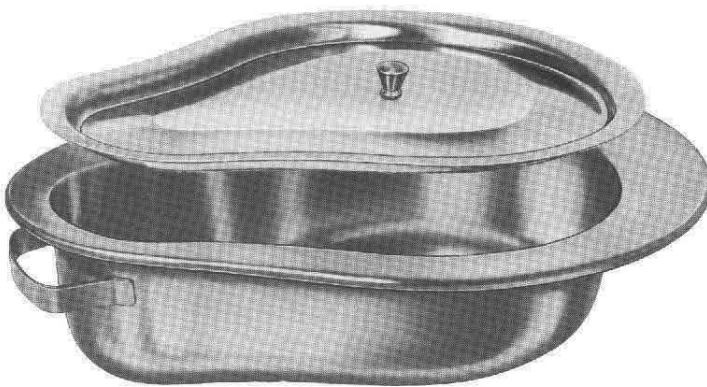

27-184

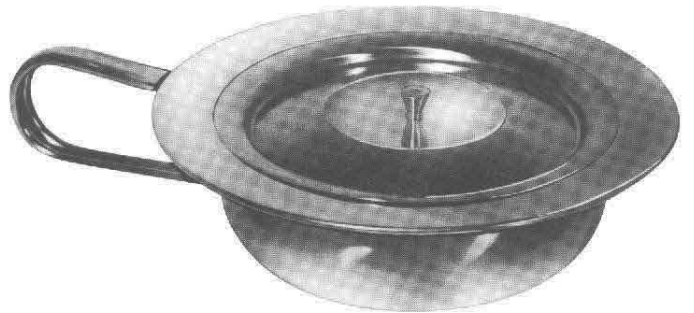

27-185 - 186

27-185 Ø 235 mm
27-186 Ø 310 mm

DENHART
INDUSTRY



27-187
Sauerbruch
210 x 125 x 17 mm



27-188
Sauerbruch
210 x 125 x 17 mm

DENHART
INDUSTRY

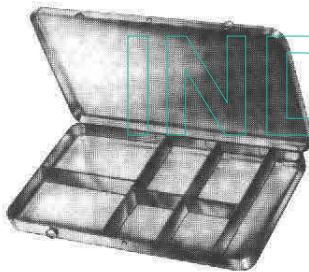

27-189
150 x 95 x 13 mm

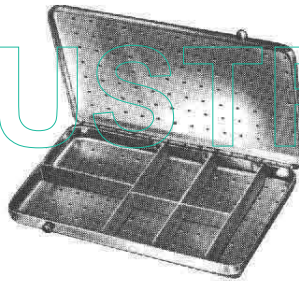

27-190
150 x 95 x 13 mm

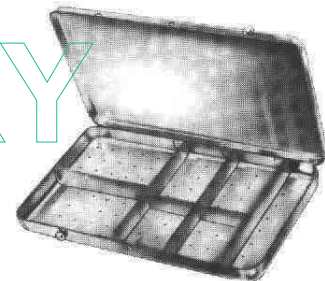

27-191
150 x 95 x 13 mm



27-192
150 x 95 x 13 mm



27-193
150 x 95 x 13 mm

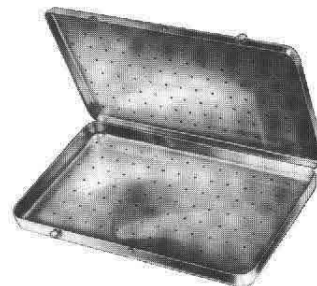

27-194
150 x 95 x 13 mm

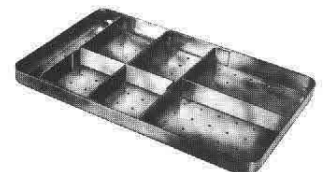

27-195
150 x 95 x 11 mm

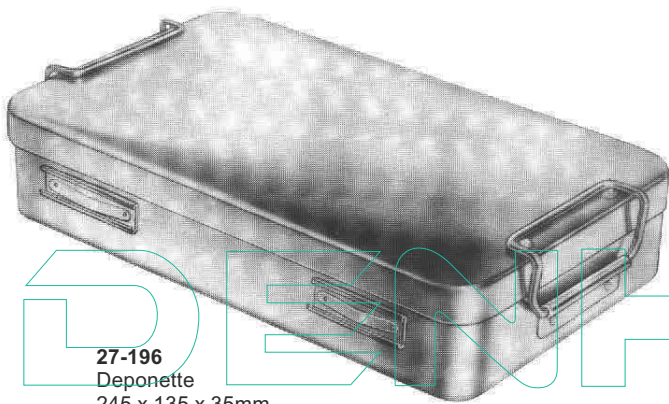

27-196
Deponette
245 x 135 x 35mm

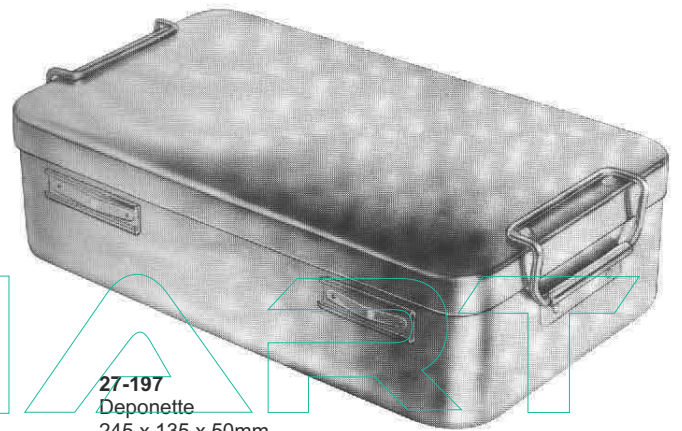

27-197
Deponette
245 x 135 x 50mm

DENHART
INDUSTRY



27-198
Deponette
245 x 135 x 60mm

DENHART
INDUSTRY

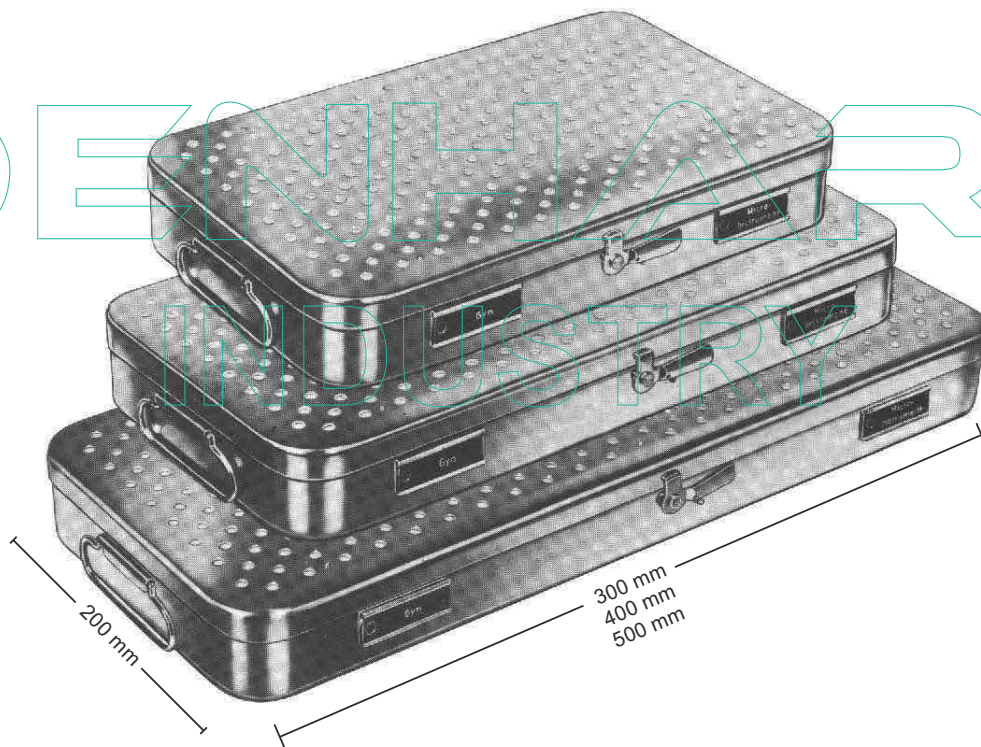

27-199 - 209

27-199	230 x 130 x 50 mm
27-200	260 x 150 x 50 mm
27-201	275 x 235 x 50 mm
27-202	300 x 200 x 50 mm
27-203	325 x 275 x 50 mm
27-204	420 x 175 x 50 mm
27-205	230 x 130 x 75 mm
27-206	260 x 150 x 75 mm
27-207	300 x 200 x 75 mm
27-208	325 x 275 x 75 mm
27-209	420 x 175 x 75 mm

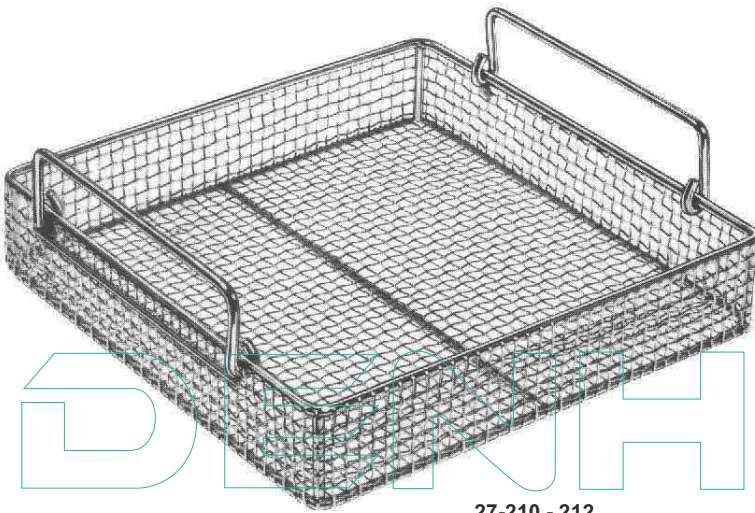

27-210 480 x 250 x 50 mm
 27-211 520 x 250 x 75 mm
 27-212 520 x 250 x 100 mm

27-210 - 212

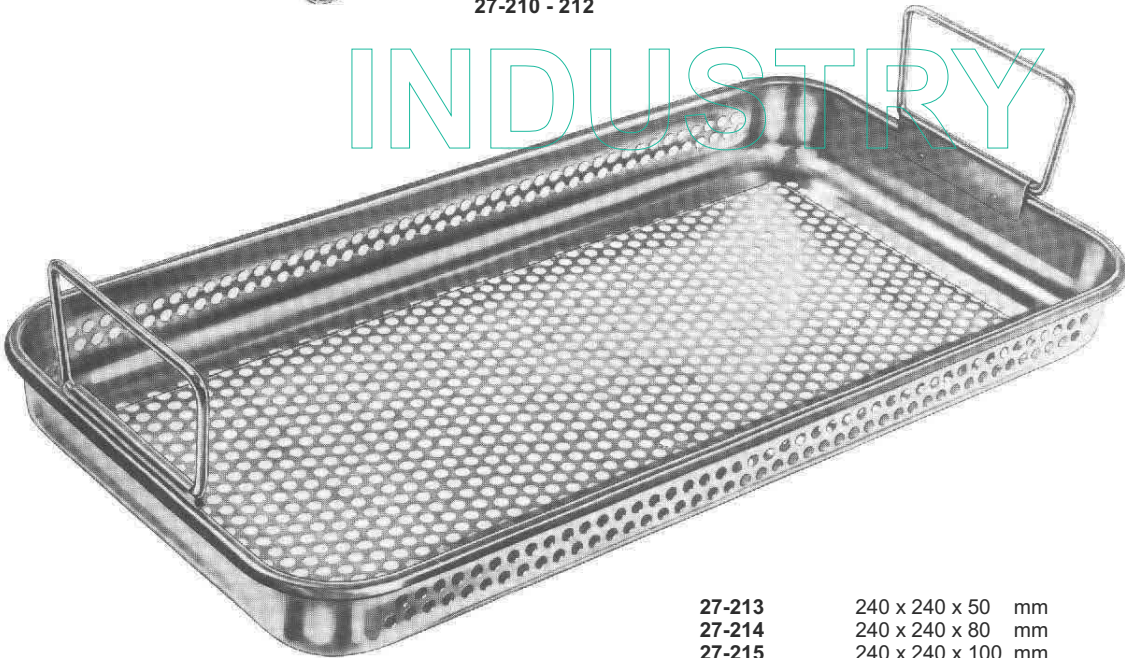

27-213 240 x 240 x 50 mm
 27-214 240 x 240 x 80 mm
 27-215 240 x 240 x 100 mm
 27-216 480 x 260 x 50 mm
 27-217 520 x 260 x 80 mm
 27-218 520 x 260 x 100 mm

27-213 - 218

DENHART INDUSTRY

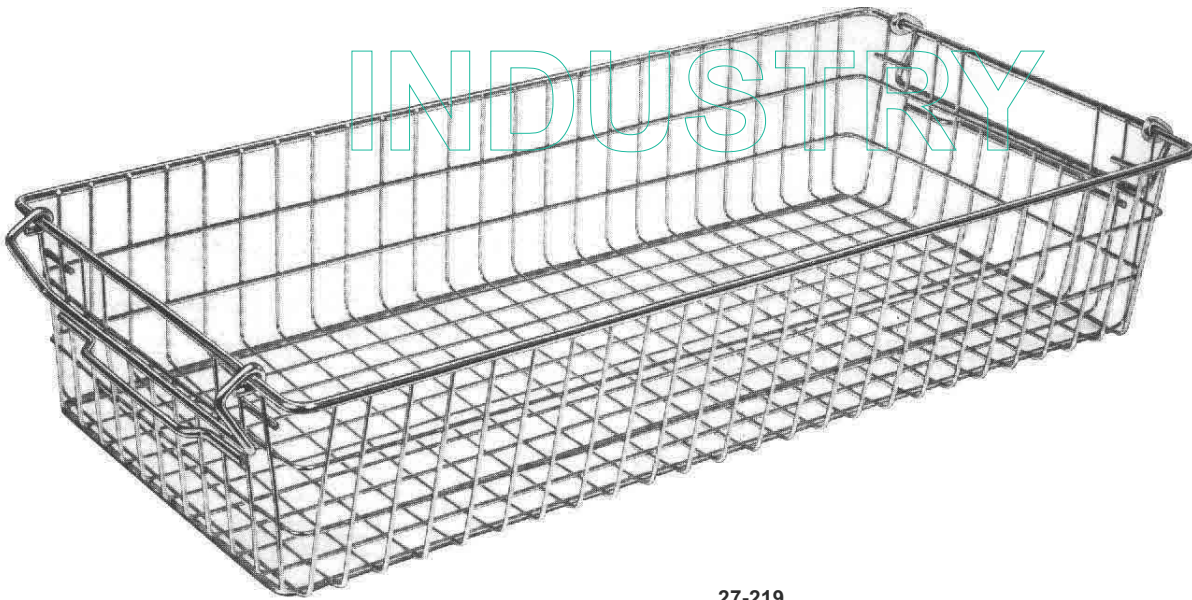

27-219
(60 x 30 x 15 cm)
Nominal dimensions



DENHART
INDUSTRY

**SURGICAL INSTRUMENTS
CATALOGUE**



Bheri Post Office Marakiwal
Sialkot, 51310 Pakistan



Tel: +971 56 608 5905
Tel: +92 307-6246984



info@denhartinds.com
mianaqib923@gmail.com